

Reference Only

Reference Spec.No.JENF243A-0018AJ-01

P1/11

Chip Ferrite Bead BLM15□□□□SN1□ REFERENCE SPECIFICATION

1.Scope

This reference specification applies to Chip Ferrite Bead BLM15_SN series.

2.Part Numbering

(ex.) BL M 15 AG 100 S N 1 D
 (1) (2) (3) (4) (5) (6) (7) (8) (9)

(1)Product ID (2)Type (3)Dimension(LxW) (4)Characteristics (5)Typical Impedance at 100MHz
 (6)Performance (7)Category (8)Numbers of Circuit (9)Packaging(D:Taping / B:Bulk)

3.Rating

Customer Part Number	MURATA Part Number	Impedance (Ω) (at 100MHz,Under Standard Testing Condition)		Rated Current (mA)	DC Resistance (Ω max.)		Remark	
		Typical			Initial Values	Values After Testing		
	BLM15AG100SN1D BLM15AG100SN1B	5~15	10	1000	0.025	0.05	For general use	
	BLM15AG700SN1D BLM15AG700SN1B	40~100	70	600	0.15	0.20		
	BLM15AG121SN1D BLM15AG121SN1B	120±25%	120	550	0.19	0.29		
	BLM15AG221SN1D BLM15AG221SN1B	220±25%	220	450	0.29	0.39		
	BLM15AG601SN1D BLM15AG601SN1B	600±25%	600	300	0.52	0.62		
	BLM15AG102SN1D BLM15AG102SN1B	1000±25%	1000	300	0.65	0.75		
	BLM15AX100SN1D BLM15AX100SN1B	5~15	10	1740	0.015	0.025		
	BLM15AX300SN1D BLM15AX300SN1B	30±25%	30	1100	0.06	0.11		
	BLM15AX700SN1D BLM15AX700SN1B	70±25%	70	780	0.10	0.15		
	BLM15AX121SN1D BLM15AX121SN1B	120±25%	120	700	0.13	0.18		
	BLM15AX221SN1D BLM15AX221SN1B	220±25%	220	600	0.18	0.23		
	BLM15AX601SN1D BLM15AX601SN1B	600±25%	600	500	0.34	0.39		
	BLM15AX102SN1D BLM15AX102SN1B	1000±25%	1000	350	0.49	0.54		
	BLM15BA050SN1D BLM15BA050SN1B	5±25%	5	300	0.10	0.15		For high speed signal line
	BLM15BB050SN1D BLM15BB050SN1B	5±25%	5	500	0.08	0.15		
	BLM15BA100SN1D BLM15BA100SN1B	10±25%	10	300	0.20	0.25		
	BLM15BB100SN1D BLM15BB100SN1B	10±25%	10	300	0.10	0.15		
	BLM15BA220SN1D BLM15BA220SN1B	22±25%	22	300	0.30	0.35		
	BLM15BB220SN1D BLM15BB220SN1B	22±25%	22	300	0.20	0.30		
	BLM15BA330SN1D BLM15BA330SN1B	33±25%	33	300	0.40	0.45		

Reference Only

Reference Spec.No.JENF243A-0018AJ-01

P2/11

Customer Part Number	MURATA Part Number	Impedance (Ω) (at 100MHz, Under Standard Testing Condition)		(Note) Rated Current (mA)	DC Resistance (Ω max.)		Remark
			Typical		Initial Values	Values After Testing	
	BLM15BA470SN1D BLM15BA470SN1B	47 \pm 25%	47	200	0.60	0.65	For high speed signal line
	BLM15BB470SN1D BLM15BB470SN1B	47 \pm 25%	47	300	0.35	0.45	
	BLM15BA750SN1D BLM15BA750SN1B	75 \pm 25%	75	200	0.80	0.85	
	BLM15BB750SN1D BLM15BB750SN1B	75 \pm 25%	75	300	0.40	0.50	
	BLM15BD750SN1D BLM15BD750SN1B	75 \pm 25%	75	300	0.20	0.30	
	BLM15BB121SN1D BLM15BB121SN1B	120 \pm 25%	120	300	0.55	0.65	
	BLM15BD121SN1D BLM15BD121SN1B	120 \pm 25%	120	300	0.30	0.4	
	BLM15BB221SN1D BLM15BB221SN1B	220 \pm 25%	220	200	0.80	0.90	
	BLM15BC121SN1D BLM15BC121SN1B	120 \pm 25%	120	350	0.45	0.50	
	BLM15BD221SN1D BLM15BD221SN1B	220 \pm 25%	220	300	0.40	0.50	
	BLM15BD471SN1D BLM15BD471SN1B	470 \pm 25%	470	200	0.60	0.70	
	BLM15BC241SN1D BLM15BC241SN1B	240 \pm 25%	240	250	0.70	0.75	
	BLM15BD601SN1D BLM15BD601SN1B	600 \pm 25%	600	200	0.65	0.75	
	BLM15BD102SN1D BLM15BD102SN1B	1000 \pm 25%	1000	200	0.90	1.0	
	BLM15BD152SN1D BLM15BD152SN1B	1500 \pm 25%	1500	190	1.0	1.1	
	BLM15BD182SN1D BLM15BD182SN1B	1800 \pm 25%	1800	100	1.4	1.5	
	BLM15BX750SN1D BLM15BX750SN1B	75 \pm 25%	75	600	0.15	0.20	
	BLM15BX121SN1D BLM15BX121SN1B	120 \pm 25%	120	600	0.17	0.22	
	BLM15BX221SN1D BLM15BX221SN1B	220 \pm 25%	220	450	0.27	0.32	
	BLM15BX471SN1D BLM15BX471SN1B	470 \pm 25%	470	350	0.41	0.46	
	BLM15BX601SN1D BLM15BX601SN1B	600 \pm 25%	600	350	0.46	0.51	
	BLM15BX102SN1D BLM15BX102SN1B	1000 \pm 25%	1000	300	0.65	0.75	
	BLM15BX182SN1D BLM15BX182SN1B	1800 \pm 25%	1800	250	0.90	1.0	

Reference Only

Reference Spec.No.JENF243A-0018AJ-01

P3/11

Customer Part Number	MURATA Part Number	Impedance (Ω) (at 100MHz, Under Standard Testing Condition)	Typical	(Note) Rated Current (mA)		DC Resistance (Ω max.)		Remark
				at 85°C	at 125°C	Initial Values	Values After Testing	
	BLM15PG100SN1D BLM15PG100SN1B	5~15	10	1000		0.025	0.05	For DC power line
	BLM15PD300SN1D BLM15PD300SN1B	30±25%	30	2200*1	1400*1	0.035	0.05	
	BLM15PD600SN1D BLM15PD600SN1B	60±25%	60	1700*1	1100*1	0.06	0.075	
	BLM15PD800SN1D BLM15PD800SN1B	80±25%	80	1500*1	1000*1	0.07	0.085	
	BLM15PD121SN1D BLM15PD121SN1B	120±25%	120	1300*1	900*1	0.09	0.105	
	BLM15PX330SN1D BLM15PX330SN1B	33±25%	33	3000*1	1700*1	0.022	0.037	
	BLM15PX600SN1D BLM15PX600SN1B	60±25%	60	2500*1	1400*1	0.032	0.047	
	BLM15PX800SN1D BLM15PX800SN1B	80±25%	80	2300*1	1300*1	0.038	0.053	
	BLM15PX121SN1D BLM15PX121SN1B	120±25%	120	2000*1	1100*1	0.055	0.070	
	BLM15PX181SN1D BLM15PX181SN1B	180±25%	180	1500*1	800*1	0.090	0.105	
	BLM15PX221SN1D BLM15PX221SN1B	220±25%	220	1400*1	800*1	0.10	0.115	
	BLM15PX331SN1D BLM15PX331SN1B	330±25%	330	1200*1	700*1	0.15	0.165	
	BLM15PX471SN1D BLM15PX471SN1B	470±25%	470	1000*1	600*1	0.20	0.22	
	BLM15PX601SN1D BLM15PX601SN1B	600±25%	600	900*1	500*1	0.23	0.25	
	BLM15KD200SN1D BLM15KD200SN1B	20±25%	20	3800*1	2350*1	0.011	0.016	
	BLM15KD300SN1D BLM15KD300SN1B	30±25%	30	3100*1	1900*1	0.017	0.022	
	BLM15KD121SN1D BLM15KD121SN1B	120±25%	120	1500*1	930*1	0.070	0.085	

■ Operating Temperature : -55°C to +125°C

■ Storage Temperature : -55°C to +125°C

(Note) As for the Rated current marked with *1, Rated Current is derated as right figure depending on the operating temperature.

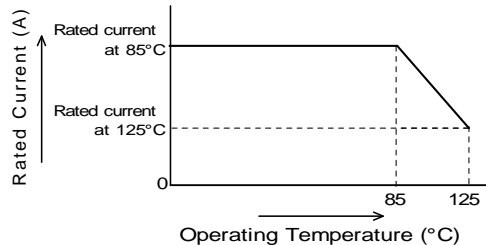

4.Style and Dimensions

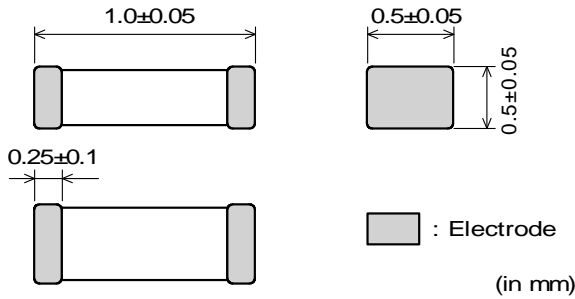

■ Equivalent Circuit



(Resistance element becomes dominant at high frequencies.)

■ Unit Mass(Typical value) 0.001g

5.Marking

No marking.

6.Standard Testing Conditions

< Unless otherwise specified >

Temperature : Ordinary Temp. (15 °C to 35 °C)
Humidity : Ordinary Humidity (25%(RH) to 85%(RH))

< In case of doubt >

Temperature : 20°C±2 °C
Humidity : 60%(RH) to 70%(RH)
Atmospheric pressure : 86kPa to 106kPa

7.Specifications

7-1.Electrical Performance

No.	Item	Specification	Test Method
7-1-1	Impedance	Meet item 3.	Measuring Frequency : 100MHz±1MHz Measuring Equipment : KEYSIGHT4291A or the equivalent Test Fixture : KEYSIGHT16192A or the equivalent
7-1-2	DC Resistance	Meet item 3.	Measuring Equipment : Digital multi meter *Except resistance of the Substrate and Wire

7-2.Mechanical Performance

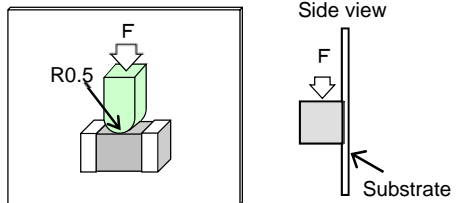
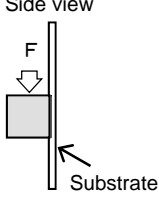
No.	Item	Specification	Test Method						
7-2-1	Appearance And Dimensions	Meet item 4.	Visual Inspection and measured with Slide Calipers.						
7-2-2	Bonding Strength	Meet Table 1. Table 1 <table border="1" style="width: 100%;"> <tr> <td>Appearance</td> <td>No damage</td> </tr> <tr> <td>Impedance Change (at 100MHz)</td> <td>Within ±30%</td> </tr> <tr> <td>DC Resistance</td> <td>Meet item 3.</td> </tr> </table>	Appearance	No damage	Impedance Change (at 100MHz)	Within ±30%	DC Resistance	Meet item 3.	It shall be soldered on the substrate. Applying Force(F) : 5N Applying Time : 5s±1s Applying Direction: Parallel to the substrate. 
Appearance	No damage								
Impedance Change (at 100MHz)	Within ±30%								
DC Resistance	Meet item 3.								
7-2-3	Bending Strength		It shall be soldered on the substrate. Substrate: Glass-epoxy 100mm×40mm×0.8mm Deflection : 2.0mm Speed of Applying Force : 0.5mm/s Keeping Time : 30s 						

Reference Only

No.	Item	Specification	Test Method
7-2-4	Vibration	Meet Table 1.	It shall be soldered on the substrate. Oscillation Frequency : 10Hz to 55Hz to 10Hz for 1 min Total Amplitude : 1.5mm Testing Time : A period of 2 hours in each of 3 mutually perpendicular directions. (Total 6 h)
7-2-5	Resistance to Soldering Heat		Pre-Heating : 150°C±10°C, 60s~90s Solder : Sn-3.0Ag-0.5Cu Solder Temperature : 270°C±5°C Immersion Time : 10s±0.5s Immersion and emersion rates : 25mm/s Then measured after exposure in the room condition for 48h±4h.
7-2-6	Drop	Products shall be no failure after tested.	It shall be dropped on concrete or steel board. Method : free fall Height : 75cm Attitude from which the product is dropped : 3 direction The number of times : 3 times for each direction (Total 9 times)
7-2-7	Solderability	The electrodes shall be at least 95% covered with new solder coating.	Flux : Ethanol solution of rosin, 25(wt)% Pre-Heating : 150°C±10°C, 60s~90s Solder : Sn-3.0Ag-0.5Cu Solder Temperature : 240°C±5°C Immersion Time : 3s±1s Immersion and emersion rates : 25mm/s

7-3.Environmental Performance

It shall be soldered on the substrate.

No.	Item	Specification	Test Method						
7-3-1	Temperature Cycle	Meet Table 1.	1 cycle : 1 step : -55 °C(+0 °C,-3 °C) / 30min±3min 2 step : Ordinary temp. / 10min to 15min 3 step : +125 °C(+3 °C,-0 °C) / 30min±3min 4 step : Ordinary temp. / 10min to 15min Total of 100 cycles Then measured after exposure in the room condition for 48h±4h.						
7-3-2	Humidity		Temperature : 40°C±2°C Humidity : 90%RH to 95%RH Time : 1000h(+48h,-0h) Then measured after exposure in the room condition for 48h±4h.						
7-3-3	Heat Life	Meet Table 2. <u>Table 2</u> <table border="1" style="width: 100%; border-collapse: collapse;"> <tr> <td style="width: 50%;">Appearance</td> <td>No damage</td> </tr> <tr> <td>Impedance Change (at 100MHz)</td> <td>Within ±30% (for BLM15PD Within ±40%)</td> </tr> <tr> <td>DC Resistance</td> <td>Meet item 3.</td> </tr> </table>	Appearance	No damage	Impedance Change (at 100MHz)	Within ±30% (for BLM15PD Within ±40%)	DC Resistance	Meet item 3.	Temperature : 125°C±3°C Applying Current : Rated Current(at 125°C) Time : 1000h(+48h,-0h) Then measured after exposure in the room condition for 48h±4h.
Appearance	No damage								
Impedance Change (at 100MHz)	Within ±30% (for BLM15PD Within ±40%)								
DC Resistance	Meet item 3.								
7-3-4	Cold Resistance	Meet Table 1.	Temperature : -55±2°C Time : 1000h(+48h,-0h) Then measured after exposure in the room condition for 48h±4h.						

(6)Dimensions of reel and taping(leader-tape, trailer-tape)

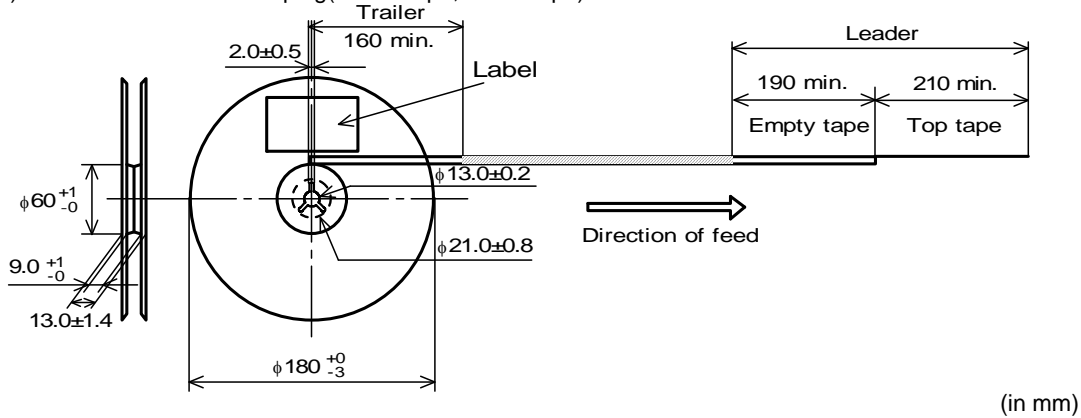

8-4. Specification of Outer Case

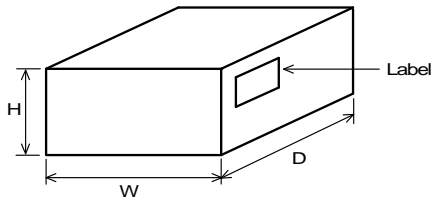

Outer Case Dimensions (mm)			Standard Reel Quantity in Outer Case (Reel)
W	D	H	
186	186	93	5

* Above Outer Case size is typical. It depends on a quantity of an order.

9. ⚠ Caution

9-1. Surge current

Excessive surge current (pulse current or rush current) than specified rated current applied to the product may cause a critical failure, such as an open circuit, burnout caused by excessive temperature rise. Please contact us in advance in case of applying the surge current.

9-2.Limitation of Applications

Please contact us before using our products for the applications listed below which require especially high reliability for the prevention of defects which might directly cause damage to the third party's life, body or property.

- (1)Aircraft equipment (2)Aerospace equipment (3)Undersea equipment (4)Power plant control equipment
- (5)Medical equipment (6)Transportation equipment(automobiles,trains,ships,etc.) (7)Traffic signal equipment
- (8)Disaster prevention / crime prevention equipment (9)Data-processing equipment
- (10)Applications of similar complexity or with reliability requirements comparable to the applications listed in the above

10.Notice

This product is designed for solder mounting.

Please consult us in advance for applying other mounting method such as conductive adhesive.

10-1.Land pattern designing

- Standard land dimensions (Reflow soldering)
- < For BLM15 series (except BLM15P□, BLM15AX, BLM15KD type) >

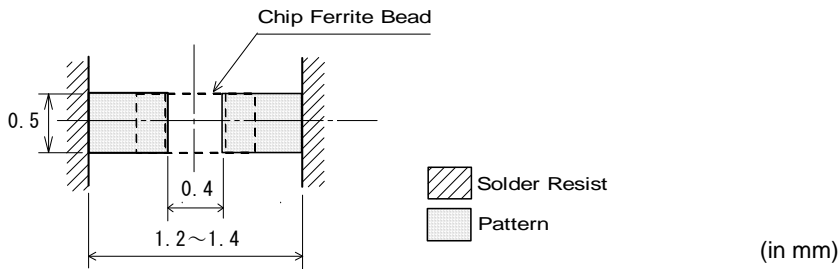

< For BLM15P□, BLM15AX, BLM15KD type >

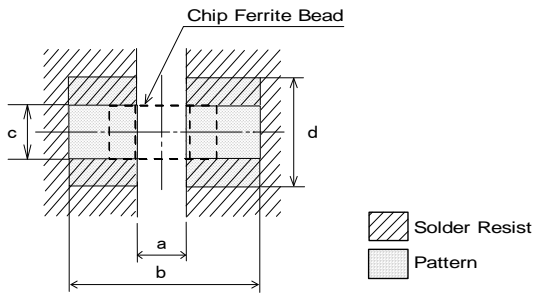

Rated Current (A)	a	b	c	Land pad thickness and dimension d		
				18μm	35μm	70μm
1.5 Max	0.4	1.2 to 1.4	0.5	0.5	0.5	0.5
2.2 Max				1.2	0.7	0.5
3.0 Max				2.4	1.2	0.5

(in mm)

*The excessive heat by land pads may cause deterioration at joint of products with substrate.

10-2. Soldering Conditions

Products can be applied to reflow soldering.

(1) Flux, Solder

Flux	Use rosin-based flux, but not highly acidic flux (with chlorine content exceeding 0.2(wt)%.) Do not use water-soluble flux.
Solder	Use Sn-3.0Ag-0.5Cu solder Standard thickness of solder paste : 100 μm to 200 μm

(2) Soldering conditions

- Pre-heating should be in such a way that the temperature difference between solder and ferrite surface is limited to 150°C max. Also cooling into solvent after soldering should be in such a way that the temperature difference is limited to 100°C max.

Insufficient pre-heating may cause cracks on the ferrite, resulting in the deterioration of product quality.

- Standard soldering profile and the limit soldering profile is as follows.

The excessive limit soldering conditions may cause leaching of the electrode and / or resulting in the deterioration of product quality.

(3) Soldering profile

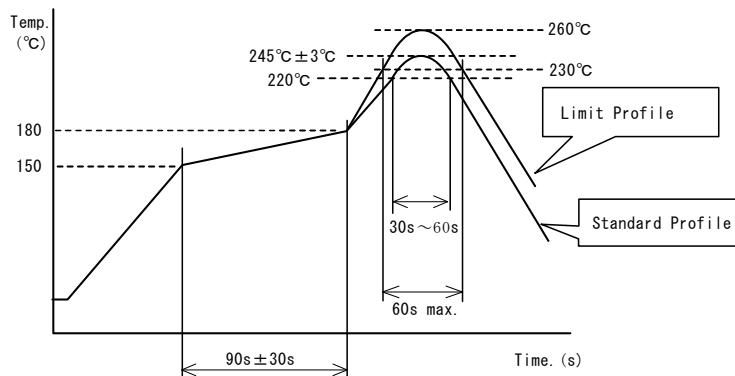

	Standard Profile	Limit Profile
Pre-heating	150~180°C、90s±30s	
Heating	above 220°C、30s~60s	above 230°C、60s max.
Peak temperature	245±3°C	260°C, 10s
Cycle of reflow	2 times	2 times

10-3. Reworking with soldering iron

- Pre-heating: 150°C, 1 min
- Tip temperature: 350°C max.
- Soldering time : 3(+1,-0) seconds.
- Soldering iron output: 80W max.
- Tip diameter: φ 3mm max.
- Times : 2times max.

Note :Do not directly touch the products with the tip of the soldering iron in order to prevent the crack on the ferrite material due to the thermal shock.

10-4.Solder Volume

Solder shall be used not to be exceed as shown below.

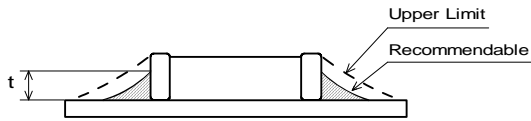

$$1/3T \leq t \leq T$$

(T:Chip thickness)

Accordingly increasing the solder volume, the mechanical stress to product is also increased. Exceeding solder volume may cause the failure of mechanical or electrical performance.

10-5.Attention regarding P.C.B. bending

The following shall be considered when designing and laying out P.C.B.'s.

- (1) P.C.B. shall be designed so that products are not subject to the mechanical stress for board warpage.

<Products direction>

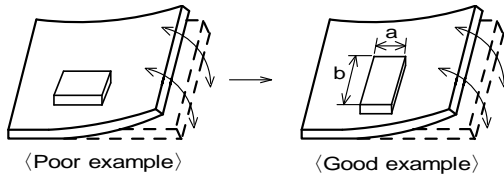

Products shall be located in the sideways direction (Length:a<b) to the mechanical stress.

- (2) Components location on P.C.B. separation.

It is effective to implement the following measures, to reduce stress in separating the board.

It is best to implement all of the following three measures; however, implement as many measures as possible to reduce stress.

Contents of Measures	Stress Level
(1) Turn the mounting direction of the component parallel to the board separation surface.	A > D *1
(2) Add slits in the board separation part.	A > B
(3) Keep the mounting position of the component away from the board separation surface.	A > C

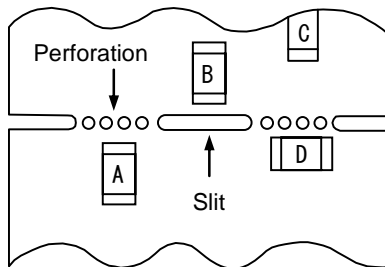

*1 A > D is valid when stress is added vertically to the perforation as with Hand Separation. If a Cutting Disc is used, stress will be diagonal to the PCB, therefore A > D is invalid.

- (3) Mounting Components Near Screw Holes

When a component is mounted near a screw hole, it may be affected by the board deflection that occurs during the tightening of the screw. Mount the component in a position as far away from the screw holes as possible.

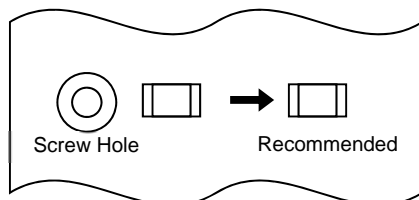

10-6.Mounting density

Add special attention to radiating heat of products when mounting the inductor near the products with heating. The excessive heat by other products may cause deterioration at joint of this product with substrate.

10-7. Operating Environment

Do not use this product under the following environmental conditions, on deterioration of the Insulation Resistance of the Ferrite material and/or corrosion of Inner Electrode may result from the use.

- (1) in the corrodible atmosphere such as acidic gases, alkaline gases, chlorine, sulfur gases, organic gases and etc. (the sea breeze, Cl₂, H₂S, NH₃, SO₂, NO₂, etc)
- (2) in the atmosphere where liquid such as organic solvent, may splash on the products.
- (3) in the atmosphere where the temperature / humidity changes rapidly and it is easy to dew.

10-8. Resin coating

The impedance value may change and/or it may affect on the product's performance due to high cure-stress of resin to be used for coating / molding products. So please pay your careful attention when you select resin. In prior to use, please make the reliability evaluation with the product mounted in your application set.

10-9. Cleaning Conditions

Products shall be cleaned on the following conditions.

- (1) Cleaning temperature shall be limited to 60°C max. (40°C max. for IPA.)
- (2) Ultrasonic cleaning shall comply with the following conditions, avoiding the resonance phenomenon at the mounted products and P.C.B.
Power: 20W/l max. Frequency: 28kHz to 40kHz Time: 5 min max.
- (3) Cleaner
 1. Alternative cleaner
 - Isopropyl alcohol (IPA)
 2. Aqueous agent
 - PINE ALPHA ST-100S
- (4) There shall be no residual flux and residual cleaner after cleaning.
In the case of using aqueous agent, products shall be dried completely after rinse with de-ionized water in order to remove the cleaner.
- (5) Other cleaning
Please contact us.

10-10. Handling of a substrate

After mounting products on a substrate, do not apply any stress to the product caused by bending or twisting to the substrate when cropping the substrate, inserting and removing a connector from the substrate or tightening screw to the substrate.

Excessive mechanical stress may cause cracking in the product.

Bending

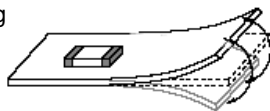

Twisting

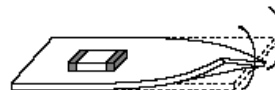

10-11. Storage Conditions

- (1) Storage period
Use the products within 6 months after delivered.
Solderability should be checked if this period is exceeded.
- (2) Storage conditions
 - Products should be stored in the warehouse on the following conditions.
Temperature : -10°C to 40°C
Humidity : 15% to 85% relative humidity
No rapid change on temperature and humidity
 - Don't keep products in corrosive gases such as sulfur, chlorine gas or acid, or it may cause oxidization of electrode, resulting in poor solderability.
 - Products should be stored on the palette for the prevention of the influence from humidity, dust and so on.
 - Products should be stored in the warehouse without heat shock, vibration, direct sunlight and so on.
 - Products should be stored under the airtight packaged condition.
- (3) Delivery
Care should be taken when transporting or handling product to avoid excessive vibration or mechanical shock.

11.  **Note**

- (1) Please make sure that your product has been evaluated in view of your specifications with our product being mounted to your product.
- (2) You are requested not to use our product deviating from the reference specifications.
- (3) The contents of this reference specification are subject to change without advance notice.
Please approve our product specifications or transact the approval sheet for product specifications before ordering.