



PBHV8540T

500 V, 0.5 A NPN high-voltage low V_{CEsat} (BISS) transistor

Rev. 02 — 14 January 2009

Product data sheet

1. Product profile

1.1 General description

NPN high-voltage low V_{CEsat} Breakthrough In Small Signal (BISS) transistor in a SOT23 (TO-236AB) small Surface-Mounted Device (SMD) plastic package.

PNP complement: PBHV9040T.

1.2 Features

- High voltage
- Low collector-emitter saturation voltage V_{CEsat}
- High collector current capability I_C and I_{CM}
- High collector current gain (h_{FE}) at high I_C
- AEC-Q101 qualified

1.3 Applications

- Electronic ballast for fluorescent lighting
- LED driver for LED chain module
- LCD backlighting
- High Intensity Discharge (HID) front lighting
- Automotive motor management
- Hook switch for wired telecom
- Switch mode power supply

1.4 Quick reference data

Table 1. Quick reference data

Symbol	Parameter	Conditions	Min	Typ	Max	Unit
V_{CESM}	collector-emitter peak voltage	$V_{BE} = 0\text{ V}$	-	-	500	V
V_{CEO}	collector-emitter voltage	open base	-	-	400	V
I_C	collector current		-	-	0.5	A
h_{FE}	DC current gain	$V_{CE} = 10\text{ V};$ $I_C = 50\text{ mA}$	100	200	-	

2. Pinning information

Table 2. Pinning

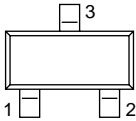
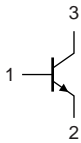
Pin	Description	Simplified outline	Graphic symbol
1	base		 sym021
2	emitter		
3	collector		

3. Ordering information

Table 3. Ordering information

Type number	Package		
	Name	Description	Version
PBHV8540T	-	plastic surface-mounted package; 3 leads	SOT23

4. Marking

Table 4. Marking codes

Type number	Marking code ^[1]
PBHV8540T	W4*

- [1] * = -: made in Hong Kong
 * = p: made in Hong Kong
 * = t: made in Malaysia
 * = W: made in China

5. Limiting values

Table 5. Limiting values

In accordance with the Absolute Maximum Rating System (IEC 60134).

Symbol	Parameter	Conditions	Min	Max	Unit
V_{CBO}	collector-base voltage	open emitter	-	500	V
V_{CEO}	collector-emitter voltage	open base	-	400	V
V_{CESM}	collector-emitter peak voltage	$V_{BE} = 0$ V	-	500	V
V_{EBO}	emitter-base voltage	open collector	-	6	V
I_C	collector current		-	0.5	A
I_{CM}	peak collector current	single pulse; $t_p \leq 1$ ms	-	1	A
I_{BM}	peak base current	single pulse; $t_p \leq 1$ ms	-	200	mA
P_{tot}	total power dissipation	$T_{amb} \leq 25$ °C	[1] -	300	mW
T_j	junction temperature		-	150	°C
T_{amb}	ambient temperature		-55	+150	°C
T_{stg}	storage temperature		-65	+150	°C

[1] Device mounted on an FR4 Printed-Circuit Board (PCB), single-sided copper, tin-plated and standard footprint.

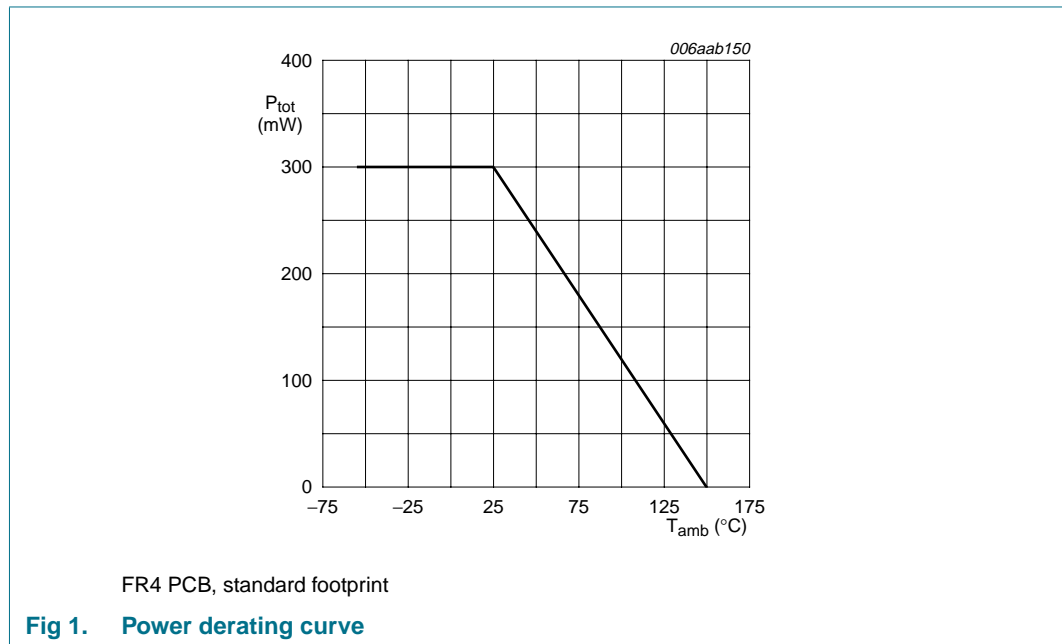

6. Thermal characteristics

Table 6. Thermal characteristics

Symbol	Parameter	Conditions	Min	Typ	Max	Unit
$R_{th(j-a)}$	thermal resistance from junction to ambient	in free air	[1]	-	417	K/W
$R_{th(j-sp)}$	thermal resistance from junction to solder point		-	-	70	K/W

[1] Device mounted on an FR4 PCB, single-sided copper, tin-plated and standard footprint.

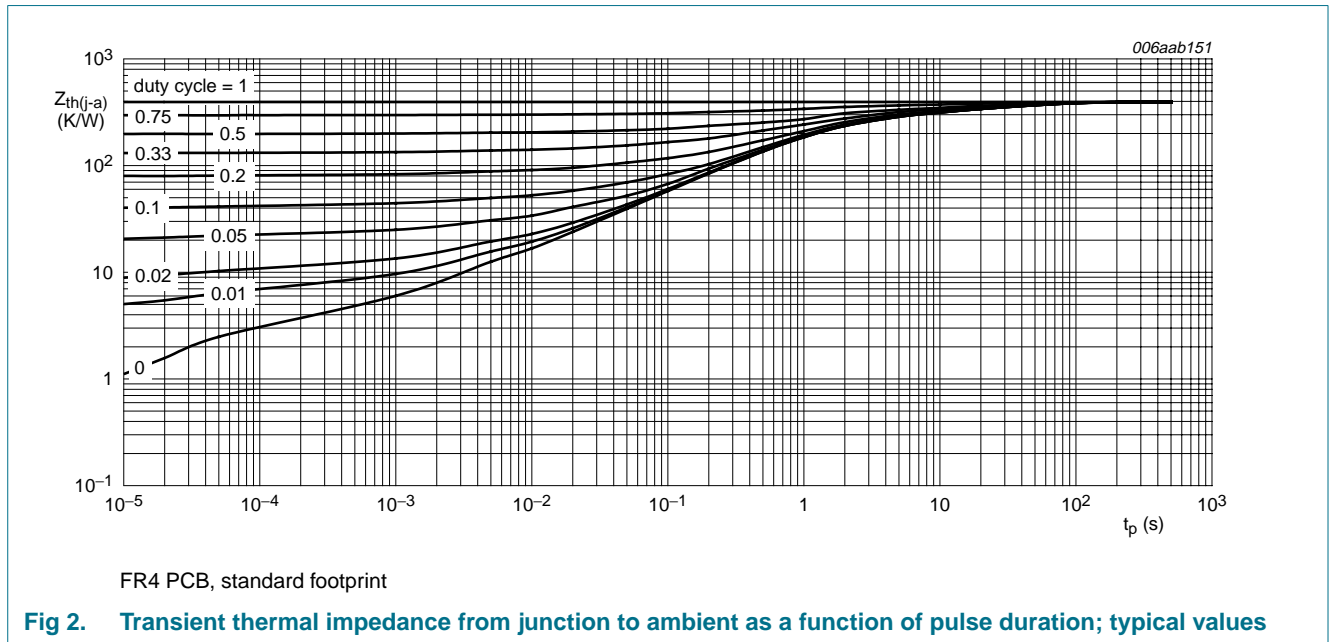

Fig 2. Transient thermal impedance from junction to ambient as a function of pulse duration; typical values

7. Characteristics

Table 7. Characteristics
 $T_{amb} = 25\text{ }^{\circ}\text{C}$ unless otherwise specified.

Symbol	Parameter	Conditions	Min	Typ	Max	Unit
I_{CBO}	collector-base cut-off current	$V_{CB} = 320\text{ V}; I_E = 0\text{ A}$	-	-	100	nA
		$V_{CB} = 320\text{ V}; I_E = 0\text{ A}; T_j = 150\text{ }^{\circ}\text{C}$	-	-	10	μA
I_{CES}	collector-emitter cut-off current	$V_{CE} = 320\text{ V}; I_C = 0\text{ A}$	-	-	100	nA
I_{EBO}	emitter-base cut-off current	$V_{EB} = 4\text{ V}; I_C = 0\text{ A}$	-	-	100	nA
h_{FE}	DC current gain	$V_{CE} = 10\text{ V}$				
		$I_C = 50\text{ mA}$	100	200	-	
		$I_C = 100\text{ mA}$	80	150	-	
		$I_C = 300\text{ mA}$	[1] 10	20	-	
V_{CEsat}	collector-emitter saturation voltage	$I_C = 100\text{ mA}; I_B = 10\text{ mA}$	-	100	200	mV
		$I_C = 100\text{ mA}; I_B = 20\text{ mA}$	-	60	90	mV
		$I_C = 300\text{ mA}; I_B = 60\text{ mA}$	-	135	250	mV
V_{BEsat}	base-emitter saturation voltage	$I_C = 300\text{ mA}; I_B = 60\text{ mA}$	[1] -	0.91	1.1	V
f_T	transition frequency	$V_{CE} = 10\text{ V}; I_C = 100\text{ mA}; f = 100\text{ MHz}$	-	30	-	MHz
C_c	collector capacitance	$V_{CB} = 20\text{ V}; I_E = i_e = 0\text{ A}; f = 1\text{ MHz}$	-	4	-	pF
C_e	emitter capacitance	$V_{EB} = 0.5\text{ V}; I_C = i_c = 0\text{ A}; f = 1\text{ MHz}$	-	165	-	pF
t_d	delay time	$V_{CC} = 6\text{ V}; I_C = 0.5\text{ A}; I_{Bon} = 0.1\text{ A}; I_{Boff} = -0.1\text{ A}$	-	50	-	ns
t_r	rise time		-	6200	-	ns
t_{on}	turn-on time		-	6250	-	ns
t_s	storage time		-	800	-	ns
t_f	fall time		-	2200	-	ns
t_{off}	turn-off time		-	3000	-	ns

[1] Pulse test: $t_p \leq 300\text{ }\mu\text{s}; \delta \leq 0.02$.

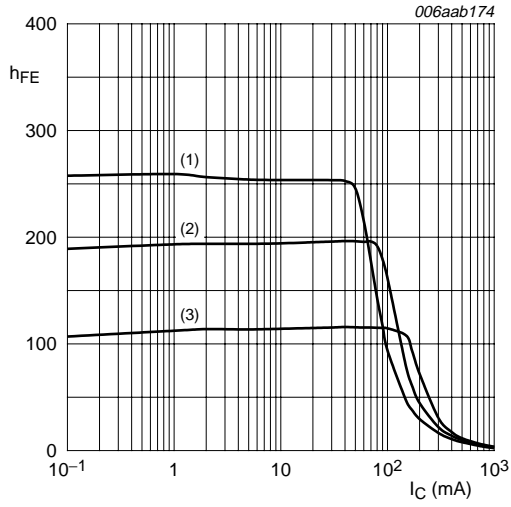

$V_{CE} = 10\text{ V}$
 (1) $T_{amb} = 100^\circ C$
 (2) $T_{amb} = 25^\circ C$
 (3) $T_{amb} = -55^\circ C$

Fig 3. DC current gain as a function of collector current; typical values

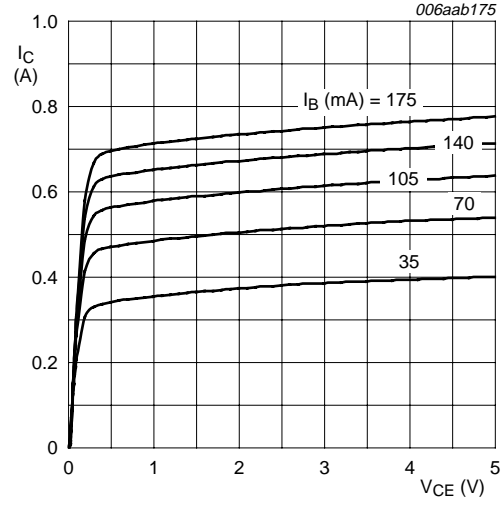

$T_{amb} = 25^\circ C$

Fig 4. Collector current as a function of collector-emitter voltage; typical values

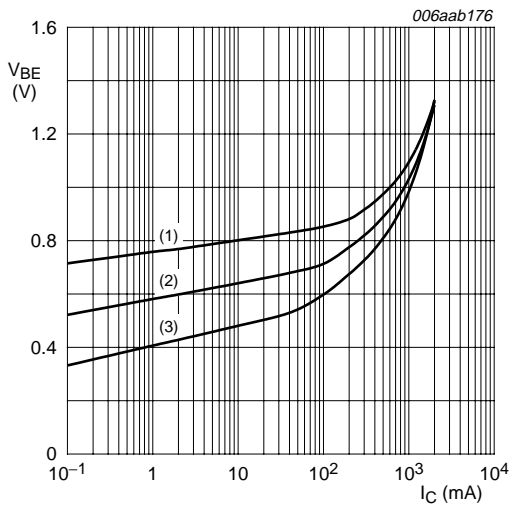

$V_{CE} = 10\text{ V}$
 (1) $T_{amb} = -55^\circ C$
 (2) $T_{amb} = 25^\circ C$
 (3) $T_{amb} = 100^\circ C$

Fig 5. Base-emitter voltage as a function of collector current; typical values

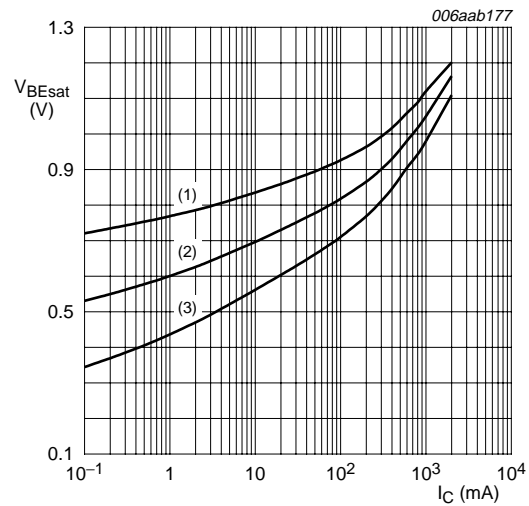

$I_C/I_B = 5$
 (1) $T_{amb} = -55^\circ C$
 (2) $T_{amb} = 25^\circ C$
 (3) $T_{amb} = 100^\circ C$

Fig 6. Base-emitter saturation voltage as a function of collector current; typical values

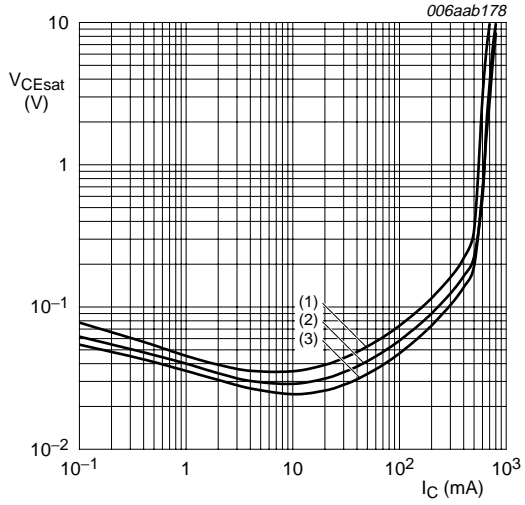

- $I_C/I_B = 5$
- (1) $T_{amb} = 100\text{ °C}$
 - (2) $T_{amb} = 25\text{ °C}$
 - (3) $T_{amb} = -55\text{ °C}$

Fig 7. Collector-emitter saturation voltage as a function of collector current; typical values

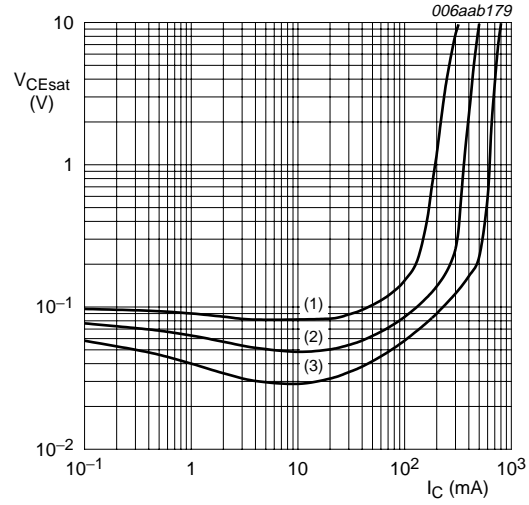

- $T_{amb} = 25\text{ °C}$
- (1) $I_C/I_B = 20$
 - (2) $I_C/I_B = 10$
 - (3) $I_C/I_B = 5$

Fig 8. Collector-emitter saturation voltage as a function of collector current; typical values

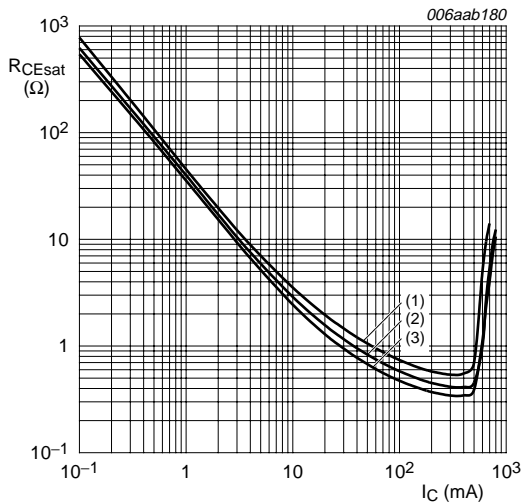

- $I_C/I_B = 5$
- (1) $T_{amb} = 100\text{ °C}$
 - (2) $T_{amb} = 25\text{ °C}$
 - (3) $T_{amb} = -55\text{ °C}$

Fig 9. Collector-emitter saturation resistance as a function of collector current; typical values

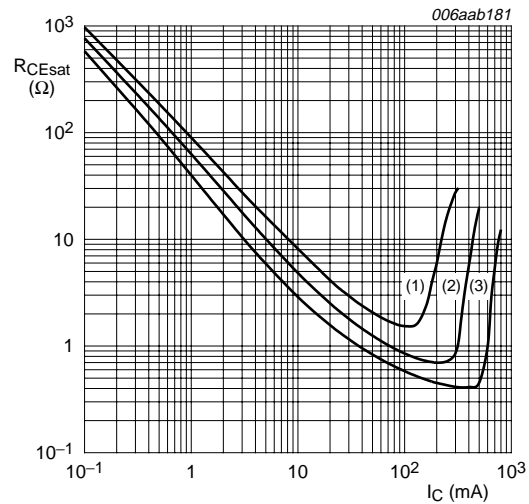

- $T_{amb} = 25\text{ °C}$
- (1) $I_C/I_B = 20$
 - (2) $I_C/I_B = 10$
 - (3) $I_C/I_B = 5$

Fig 10. Collector-emitter saturation resistance as a function of collector current; typical values

8. Test information

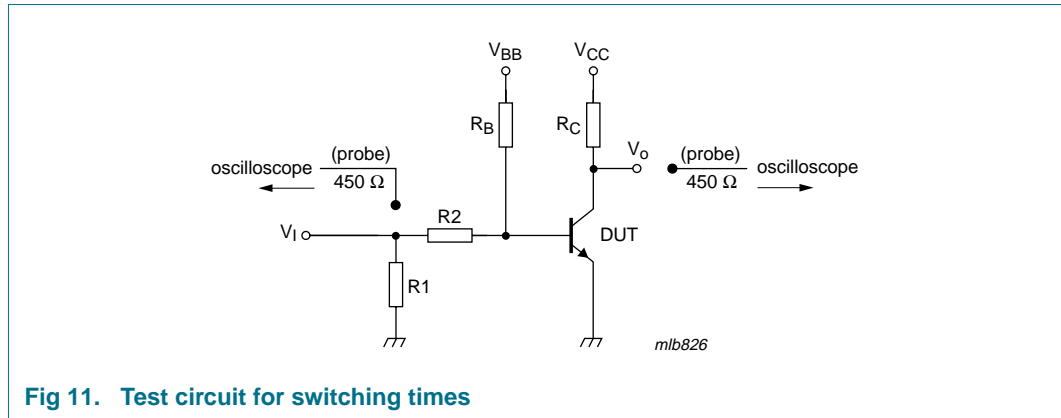

Fig 11. Test circuit for switching times

8.1 Quality information

This product has been qualified in accordance with the Automotive Electronics Council (AEC) standard *Q101 - Stress test qualification for discrete semiconductors*, and is suitable for use in automotive applications.

9. Package outline

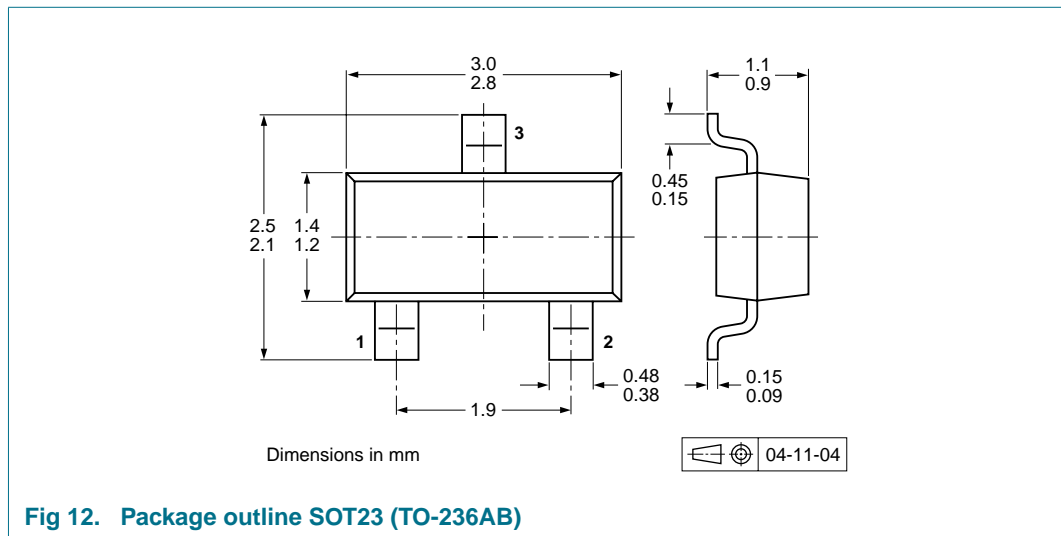

Fig 12. Package outline SOT23 (TO-236AB)

10. Packing information

Table 8. Packing methods

The indicated -xxx are the last three digits of the 12NC ordering code.^[1]

Type number	Package	Description	Packing quantity	
			3000	10000
PBHV8540T	SOT23	4 mm pitch, 8 mm tape and reel	-215	-235

[1] For further information and the availability of packing methods, see [Section 14](#).

11. Soldering

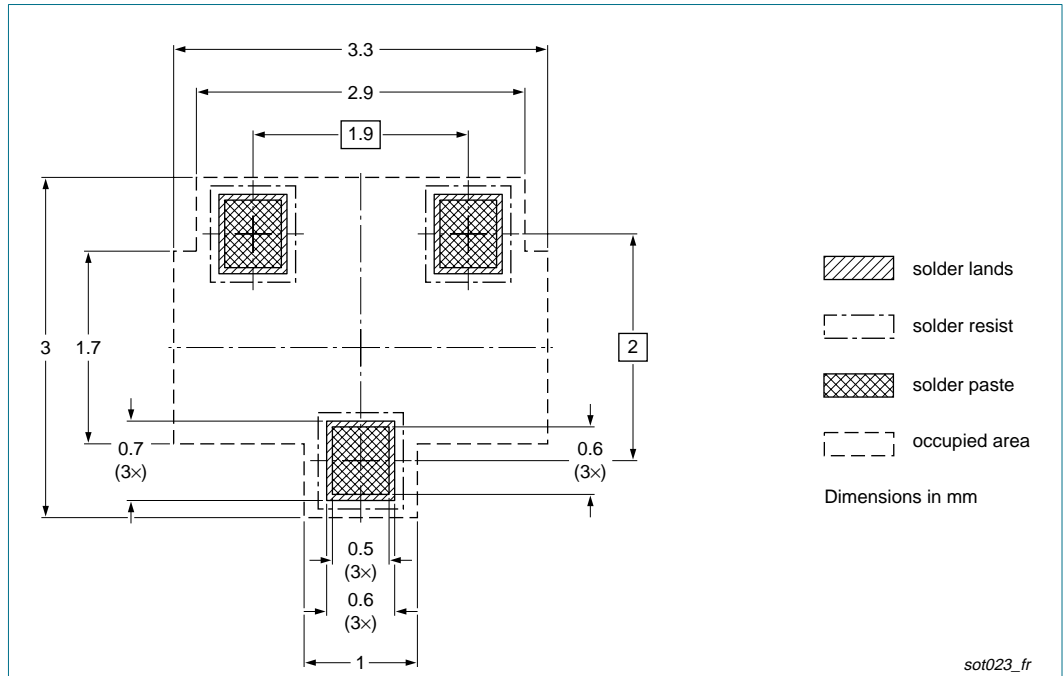

Fig 13. Reflow soldering footprint SOT23 (TO-236AB)

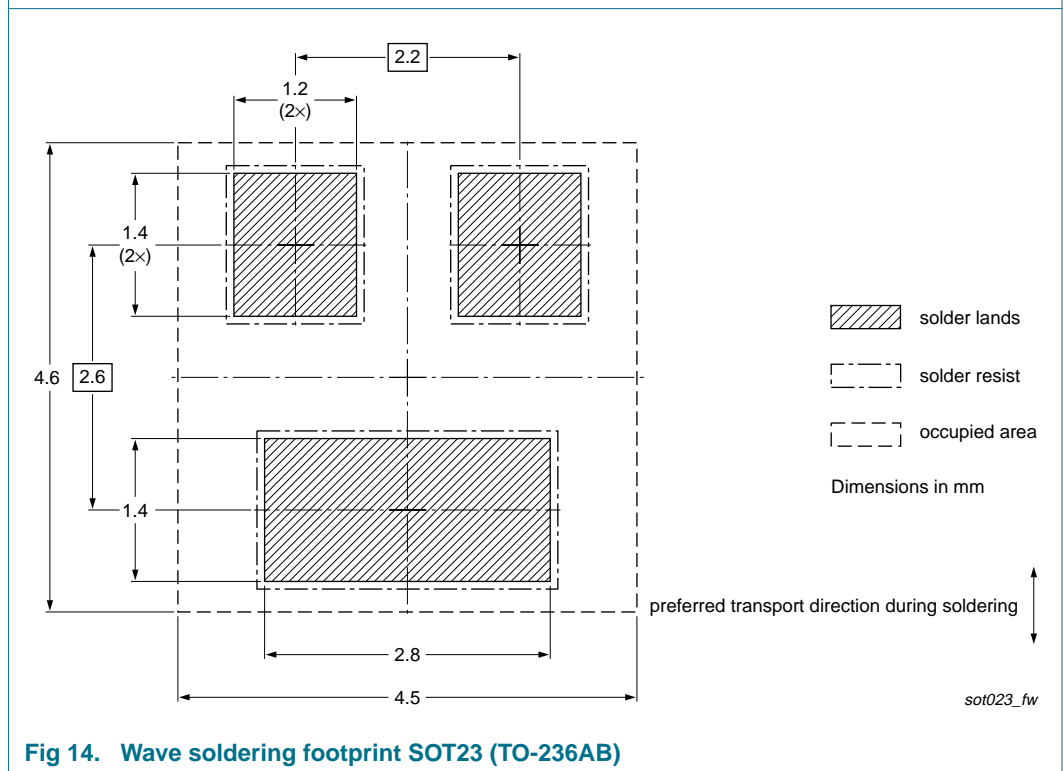

Fig 14. Wave soldering footprint SOT23 (TO-236AB)