

BC807/BC808

Switching and Amplifier Applications

- Suitable for AF-Driver stages and low power output stages
- Complement to BC817/BC818

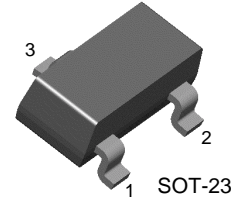

1. Base 2. Emitter 3. Collector

PNP Epitaxial Silicon Transistor

Absolute Maximum Ratings $T_a=25^\circ\text{C}$ unless otherwise noted

Symbol	Parameter	Value	Units
V_{CES}	Collector-Emitter Voltage		
	: BC807	-50	V
	: BC808	-30	V
V_{CEO}	Collector-Emitter Voltage		
	: BC807	-45	V
	: BC808	-25	V
V_{EBO}	Emitter-Base Voltage	-5	V
I_C	Collector Current (DC)	-800	mA
P_C	Collector Power Dissipation	-310	mW
T_J	Junction Temperature	150	$^\circ\text{C}$
T_{STG}	Storage Temperature	-65 ~ 150	$^\circ\text{C}$

Electrical Characteristics $T_a=25^\circ\text{C}$ unless otherwise noted

Symbol	Parameter	Test Condition	Min.	Typ.	Max.	Units
BV_{CEO}	Collector-Emitter Breakdown Voltage	$I_C = -10\text{mA}, I_B = 0$				
	: BC807		-45			V
	: BC808		-25			V
BV_{CES}	Collector-Emitter Breakdown Voltage	$I_C = -0.1\text{mA}, V_{BE} = 0$				
	: BC807		-50			V
	: BC808		-30			V
BV_{EBO}	Emitter-Base Breakdown Voltage	$I_E = -0.1\text{mA}, I_C = 0$	-5			V
I_{CES}	Collector Cut-off Current	$V_{CE} = -25\text{V}, V_{BE} = 0$			-100	nA
I_{EBO}	Emitter Cut-off Current	$V_{EB} = -4\text{V}, I_C = 0$			-100	nA
h_{FE1}	DC Current Gain	$V_{CE} = -1\text{V}, I_C = -100\text{mA}$	100		630	
h_{FE2}		$V_{CE} = -1\text{V}, I_C = -300\text{mA}$	60			
$V_{CE}(\text{sat})$	Collector-Emitter Saturation Voltage	$I_C = -500\text{mA}, I_B = -50\text{mA}$			-0.7	V
$V_{BE}(\text{on})$	Base-Emitter On Voltage	$V_{CE} = -1\text{V}, I_C = -300\text{mA}$			-1.2	V
f_T	Current Gain Bandwidth Product	$V_{CE} = -5\text{V}, I_C = -10\text{mA}$ $f = 50\text{MHz}$		100		MHz
C_{ob}	Output Capacitance	$V_{CB} = -10\text{V}, f = 1\text{MHz}$			12	pF

h_{FE} Classification

Classification	16	25	40
h_{FE1}	100 ~ 250	160 ~ 400	250 ~ 630
h_{FE2}	60-	100-	170-

Marking Code

Type	807-16	807-25	807-40	808-16	808-25	808-40
Marking	9FA	9FB	9FC	9GA	9GB	9GC

Typical Characteristics

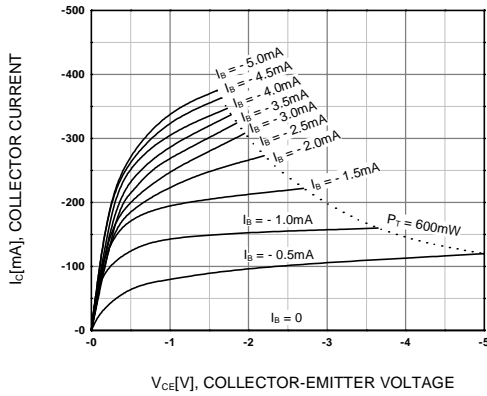

Figure 1. Static Characteristic

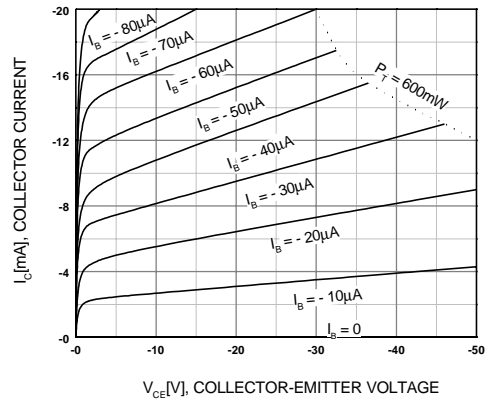

Figure 2. Static Characteristic

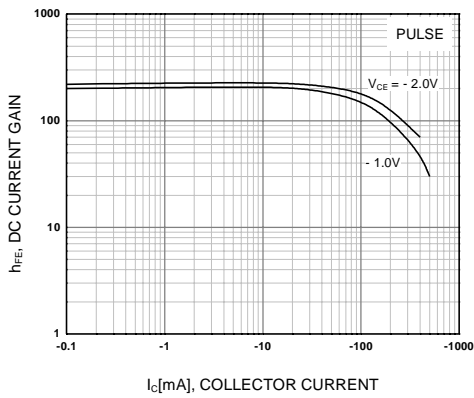

Figure 3. DC current Gain

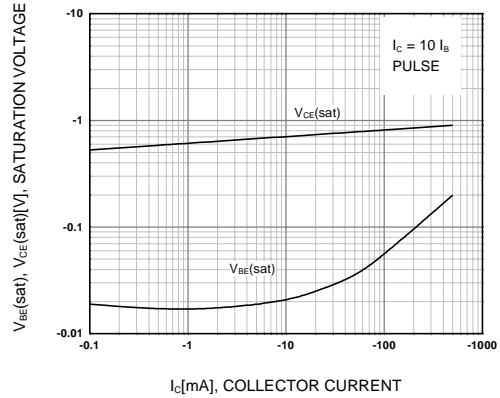

Figure 4. Base-Emitter Saturation Voltage
Collector-Emitter Saturation Voltage

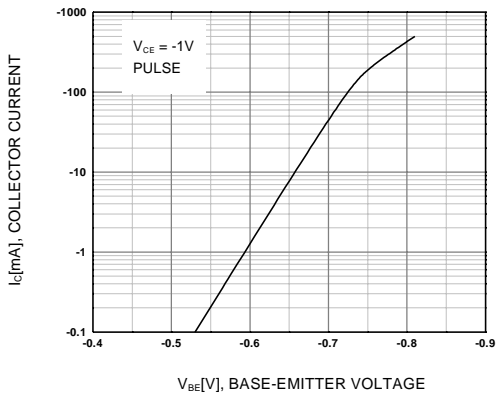

Figure 5. Base-Emitter On Voltage

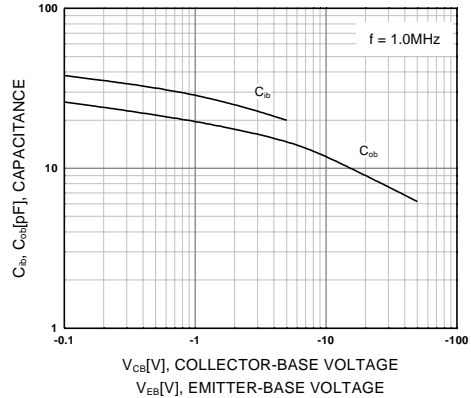

Figure 6. Input Output Capacitance

Typical Characteristics (Continued)

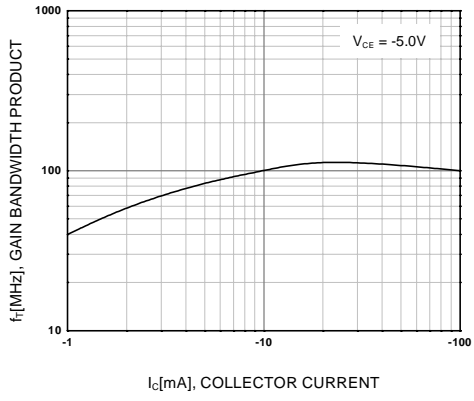
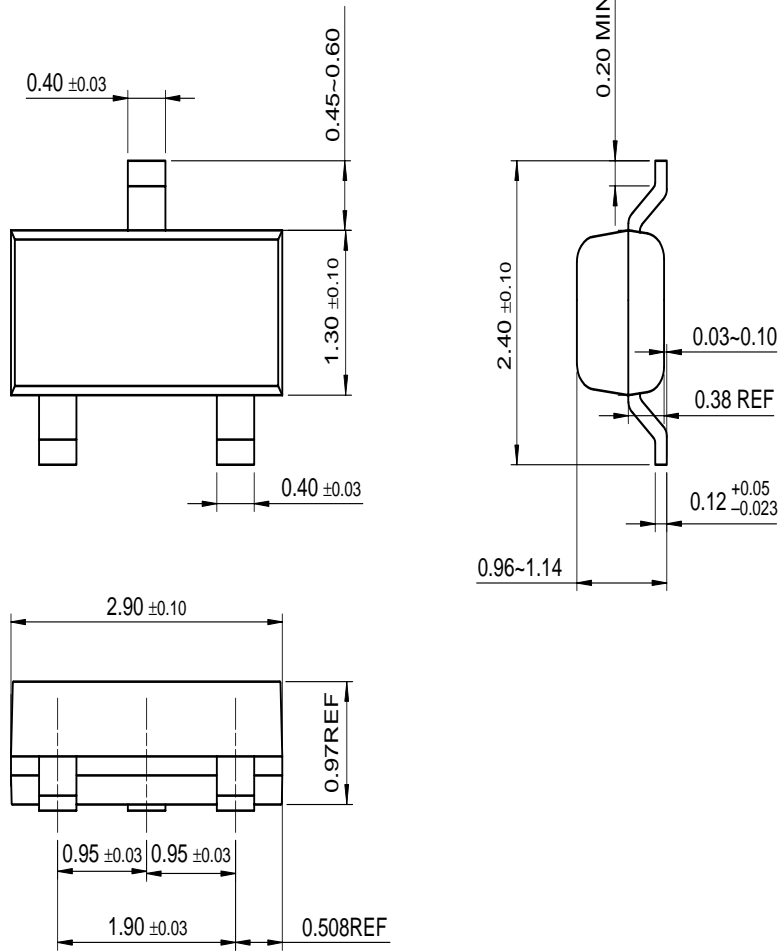

Figure 7. Current Gain Bandwidth Product

Package Dimensions

SOT-23



Dimensions in Millimeters