

FD6288T&Q

3-PHASE BRIDGE DRIVER

Description

FD6288T&Q is an integrated three-span half-bridge gate driver IC designed for high voltage, high speed drive MOSFETs that operate up to +250V. The special HVIC technology can realize stable monolithic structure. Logic inputs are compatible with CMOS or LSTTL outputs, and the logic voltage can be down to 3.3V. The output driver has a high pulse current buffer stage, which aims to achieve a minimum driver impedance. Propagation delays are matched to simplify use in high frequency applications. Floating channel can be used to drive N-channel power MOSFET with high-end configuration, working voltage up to 250V.

Features

- Fully operational to +250V
- Gate driver supply range from 5V to 20V
- Independent Three half-bridge drivers
- 3.3V/5V logic input compatible
- Undervoltage lockout for all channels
- Cross-conduction prevention logic
- Internal set dead-time
- Matched propagation delay for both channels
- Outputs in phase with inputs
- RoHS compliant

Packages



TSSOP-20

QFN-24

Applications

- Motor drives
- DC-AC inverter drives

Absolute Maximum Ratings

Absolute maximum ratings indicate sustained limits beyond which damage to the device may occur. All voltage parameters are absolute voltages referenced to COM. The thermal resistance and power dissipation ratings are measured under board mounted and still air condition.

Definition	Symbol	Min~Max	Units
High side floating supply voltage	$V_{B1,2,3}$	-0.3~275	V
High side floating supply offset voltage	$V_{S1,2,3}$	$V_{B1,2,3}-25 \sim V_{B1,2,3}+0.3$	V
High side floating output voltage	$V_{HO1,2,3}$	$V_{S1,2,3}-0.3 \sim V_{B1,2,3}+0.3$	V
Low side and logic fixed supply voltage	V_{CC}	-0.3~25	V
Low side output voltage	$V_{LO1,2,3}$	-0.5~ $V_{CC}+0.3$	V
Logic input voltage (HIN,LIN)	V_{IN}	-0.5~ $V_{CC}+0.3$	V
Allowable offset supply voltage transient	dV_S/dt	≤ 50	V/ns
Package power dissipation @ $T_A \leq 25^\circ\text{C}$	P_D	20 lead TSSOP	≤ 1.25
		24 lead QFN	≤ 3.0
Thermal resistance, junction to ambient	R_{thJA}	20 lead TSSOP	≤ 100
		24 lead QFN	≤ 42
Junction temperature	T_j	≤ 150	$^\circ\text{C}$
Storage temperature	T_{stg}	-55~150	$^\circ\text{C}$

Note1: In any case, power dissipation should not exceed P_D .

Note2: Voltages above the absolute maximum ratings may damage the chip.

Recommended Operating Conditions

For proper operation the device should be used within the recommended conditions. The V_S offset rating is tested with all supplies biased at a 15V differential.

Definition	Symbol	Min	Max	Units
High side floating supply voltage	$V_{B1,2,3}$	$V_{S1,2,3}+5$	$V_{S1,2,3}+20$	V
High side floating supply offset voltage	$V_{S1,2,3}$	Note1	250	V
High side floating output voltage	$V_{HO1,2,3}$	V_S	$V_{B1,2,3}$	V
Low side and logic fixed supply voltage	V_{CC}	5	20	V
Low side output voltage	$V_{LO1,2,3}$	0	V_{CC}	V
Logic input voltage (HIN,LIN)	V_{IN}	0	V_{CC}	V
Ambient temperature	T_A	-40	125	$^\circ\text{C}$

Note1: Logic operational for V_S of (COM – 4V) to (COM + 600V). Logic state held for V_S of (COM – 4V) to (COM – V_{BS}).

Note2: The long-term operation of the chip outside the recommended conditions may affect its reliability. It is not recommended to work in an environment that exceeds the recommended conditions.

Static Electrical Characteristics
 $V_{BIAS} (V_{CC}, V_{BS1,2,3}) = 15V$ and $T_A = 25^\circ C$ unless otherwise specified. All the parameters are referenced to COM.

Definition	Symbol	Test conditions	Min.	Typ.	Max.	Units
Logic "1" input voltage	V_{IH}		2.7	-	-	V
Logic "0" input voltage	V_{IL}		-	-	0.8	
High level output voltage, $V_{BIAS} - V_O$	V_{OH}	$I_O = 100mA$	-	0.6	0.9	
low level output voltage, V_O	V_{OL}		-	0.3	0.45	
Offset supply leakage current	I_{LK}	$V_{B1,2,3} = V_{S1,2,3} = 250V$	-	0.1	5.0	uA
Quiescent V_{BS} supply current	I_{QBS}	$V_{IN} = 0V$ or $5V$	-	180	270	
Quiescent V_{CC} supply current	I_{QCC}		-	330	500	
Logic "1" input bias current	I_{IN+}	$V_{IN} = 5V$	-	25	40	
Logic "0" input bias current	I_{IN-}	$V_{IN} = 0V$	-	-	1	
V_{CC} and V_{BS} supply undervoltage positive going threshold	V_{CCUV+} V_{BSUV+}		4.2	4.6	5.0	V
V_{CC} and V_{BS} supply undervoltage negative going threshold	V_{CCUV-} V_{BSUV-}		3.9	4.3	4.7	
Output high short circuit pulsed current	I_{O+}	$V_O = 0V, PW \leq 10\mu s$	1.1	1.5	1.9	A
Output low short circuit pulsed current	I_{O-}	$V_O = 15V, PW \leq 10\mu s$	1.3	1.8	2.3	

Dynamic Electrical Characteristics
 $V_{BIAS} (V_{CC}, V_{BS1,2,3}) = 15V$, $C_L = 1000pF$, and $T_A = 25^\circ C$, unless otherwise specified.

Definition	Symbol	Test conditions	Min.	Typ.	Max.	Units
Turn on propagation delay	t_{on}	$V_{S1,2,3} = 0V$	-	300	450	ns
Turn off propagation delay	t_{off}	$V_{S1,2,3} = 250V$	-	100	160	
Delay matching, HS & LS turn on/off	MT		-	-	30	
Turn on rise time	t_r		-	12	25	
Turn off fall time	t_f		-	12	25	
Deadtime, LS turn-off to HS turn-on & HS turn-off to LS turn-on	DT		100	200	300	

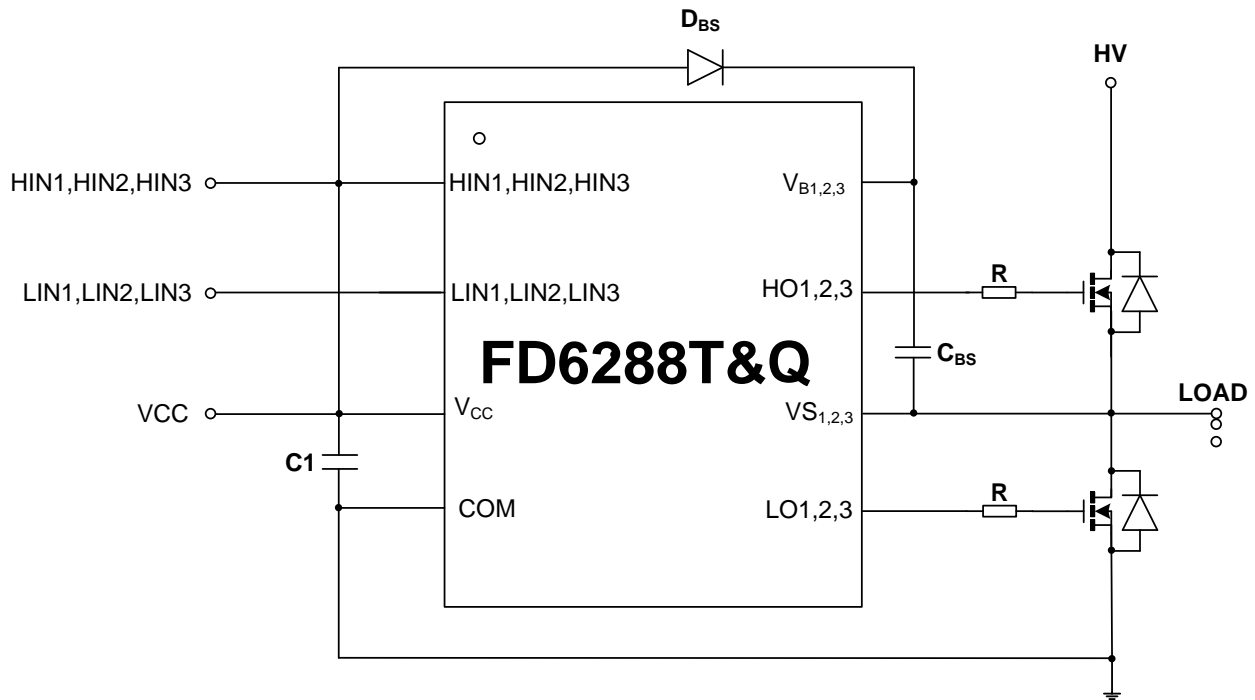
Typical Connection

C1: Power filter capacitor, according to the circuit can choose $1\mu\text{F} \sim 10\mu\text{F}$, as close to the chip pin as possible.

R: Gate drive resistor, and the resistance depends on the device being driven.

D_{BS} : Bootstrap diodes. It should be selected for high reverse breakdown voltage Schottky diodes.

C_{BS} : Bootstrap capacitors. Ceramic capacitors or tantalum capacitors should be selected, according to the circuit can choose $0.22\mu\text{F} \sim 10\mu\text{F}$. The capacitor should be as close as possible to the chip pin.

Note:

The above circuits and parameters are for reference only. The actual application circuit should be designed with the measured results in setting the parameters.

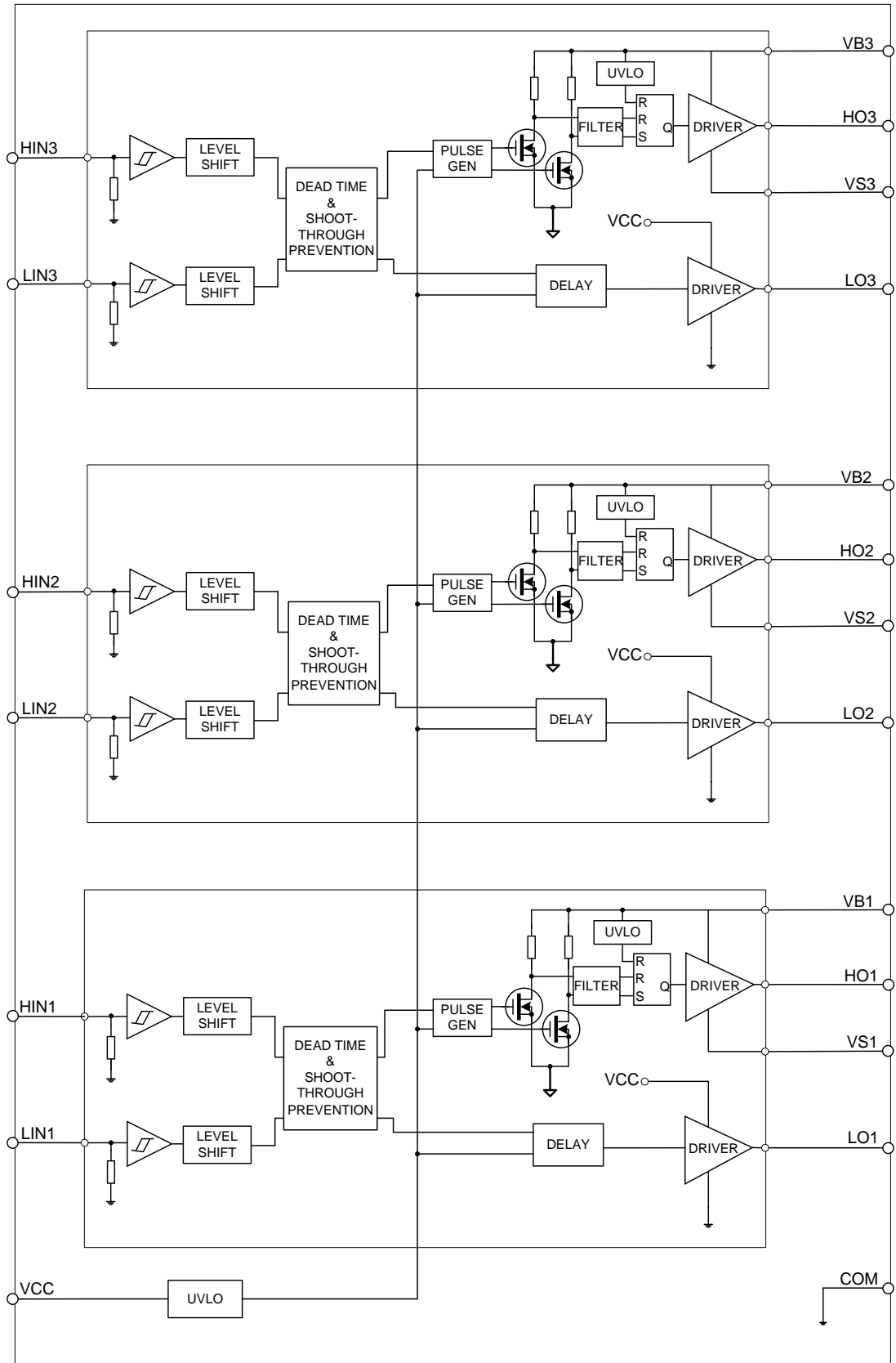
Functional Block Diagram

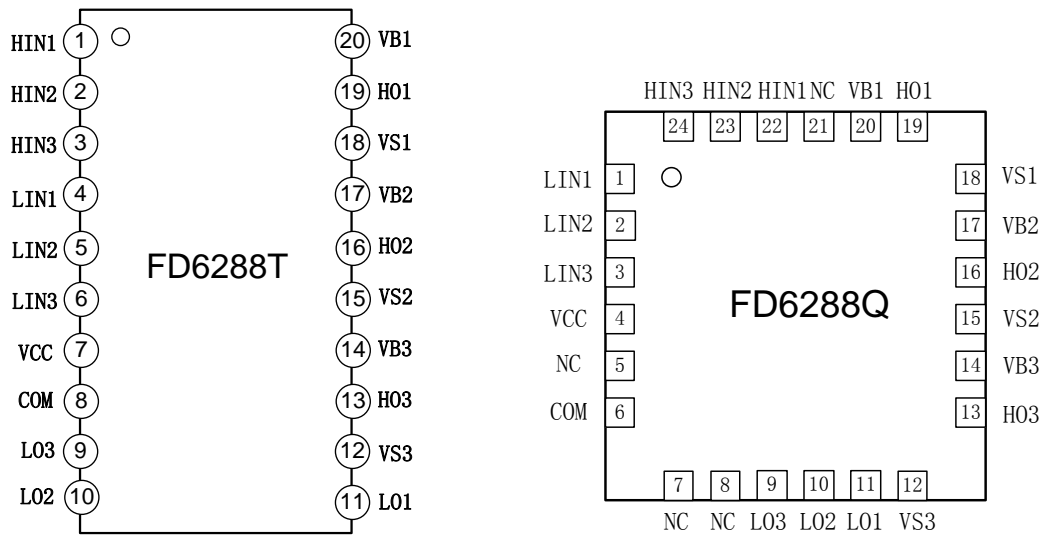
Lead Assignments

Lead definitions

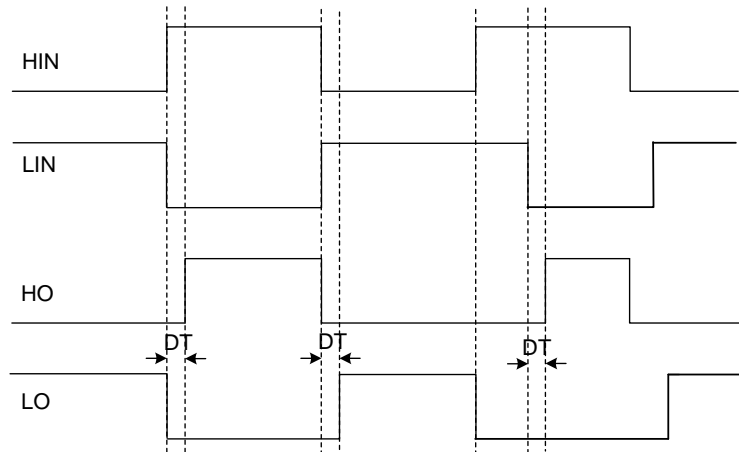
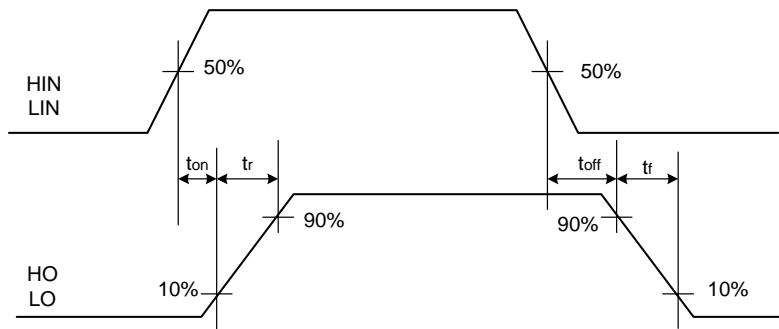
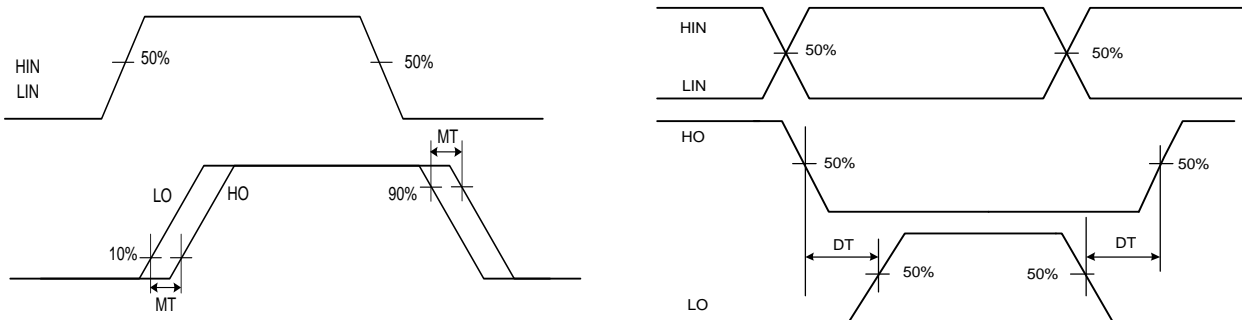
Symbol	Description
V _{CC}	Low side and logic fixed supply
HIN1,2,3	Logic input for high side gate driver output(HO),in phase
LIN1,2,3	Logic input for low side gate driver output(LO),in phase
COM	Low side return
LO1,2,3	Low side gate drive output
V _{S1,2,3}	High side floating supply return
H01,2,3	High side gate drive output
V _{B1,2,3}	High side floating supply

Input/Output Timing Diagram

Switching Time Waveform Definitions

Delay Matching Waveform Definitions and Deadtime Waveform Definitions

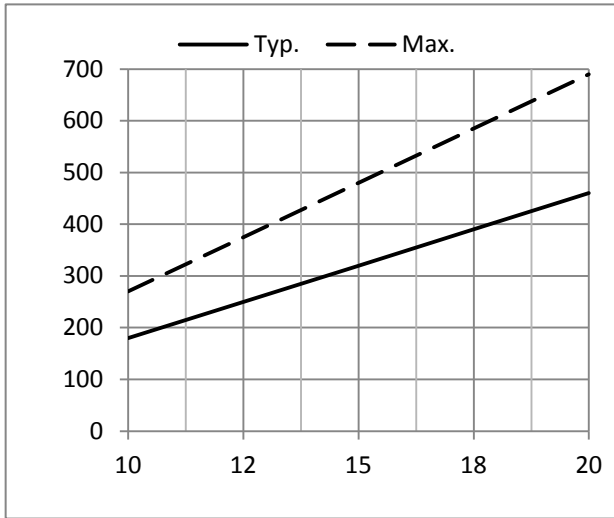

Figure 1A V_{CC} Supply Current vs Supply Voltage

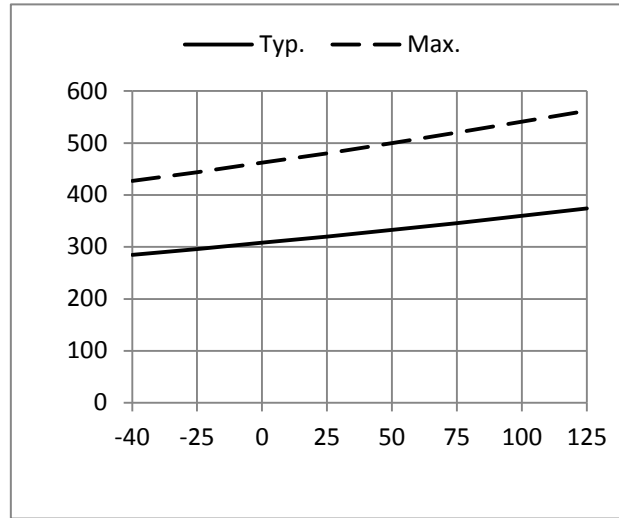

Figure 1B V_{CC} Supply Current vs Temperature

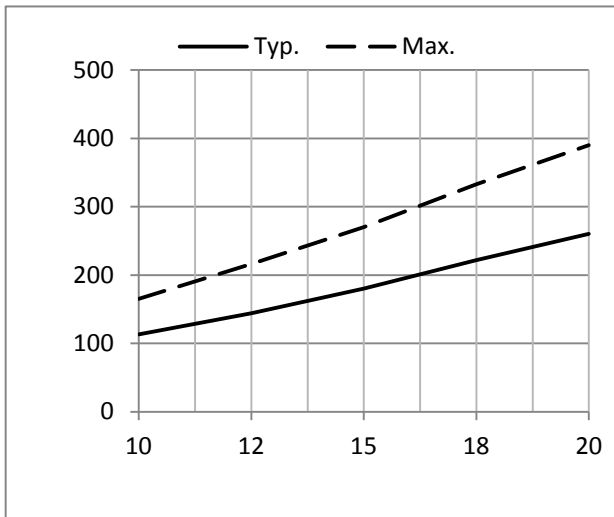

Figure 2A V_{BS} Supply Current vs Supply Voltage

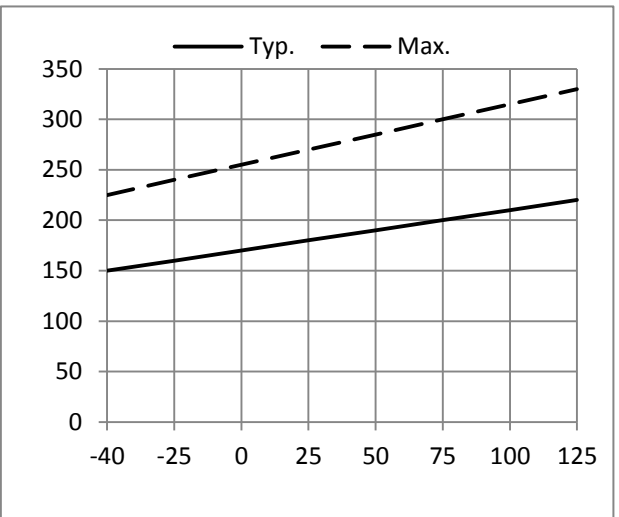
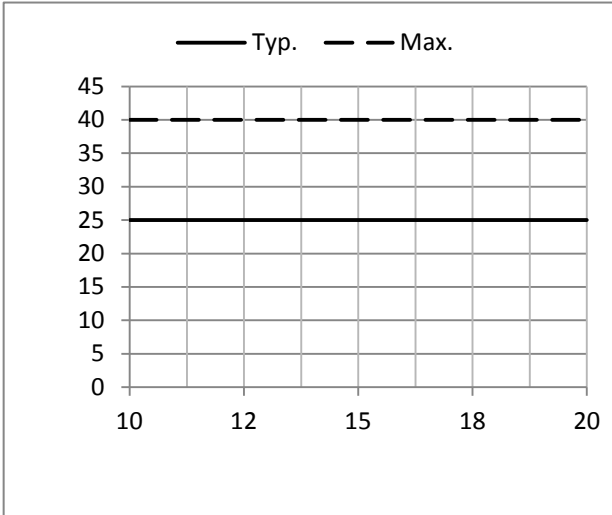
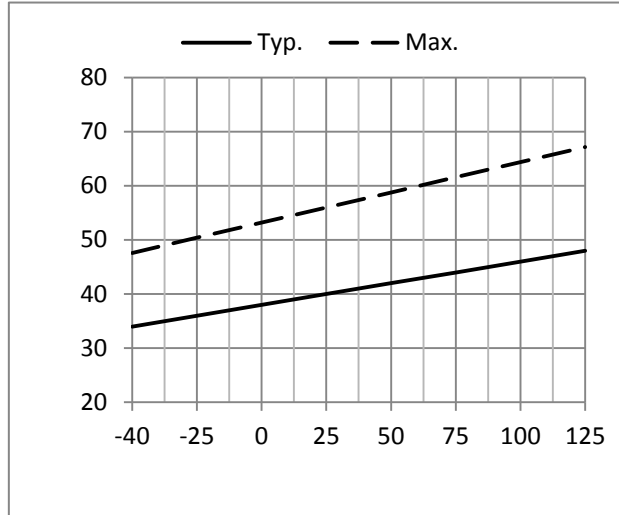
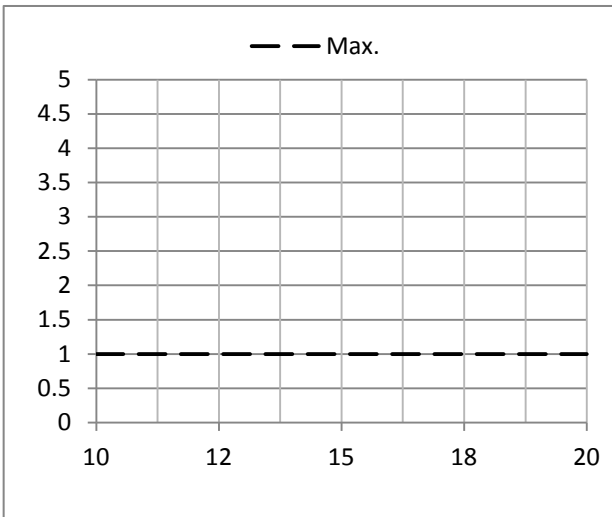
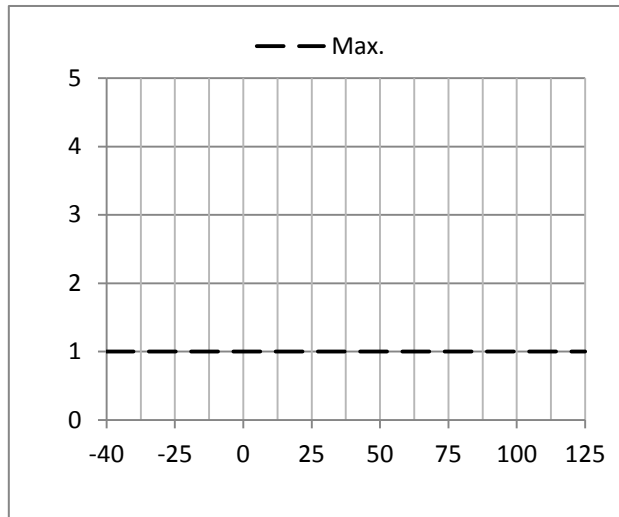
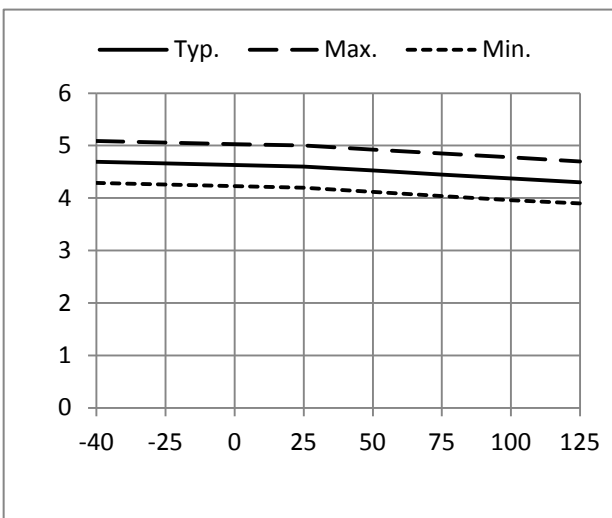
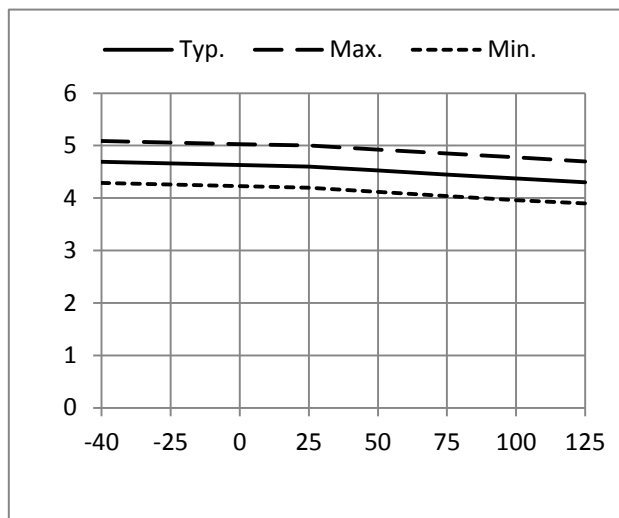

Figure 2B V_{BS} Supply Current vs Temperature

Figure 3A Logic "1" Input Current vs Supply Voltage

Figure 3B Logic "1" Input Current vs Temperature

Figure 4A Logic "0" Input Current vs Supply Voltage

Figure 4B Logic "0" Input Current vs Temperature

Figure 5A V_{CC} Undervoltage Threshold(+) vs Temperature

Figure 5B V_{CC} Undervoltage Threshold(-) vs Temperature

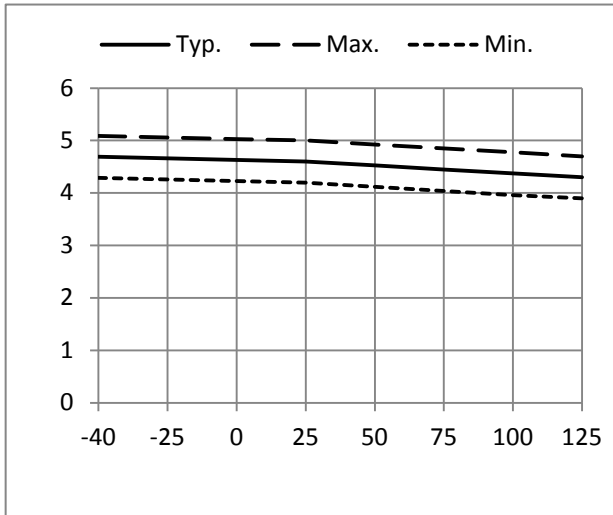

Figure 6A V_{BS} Undervoltage Threshold(+) vs Temperature

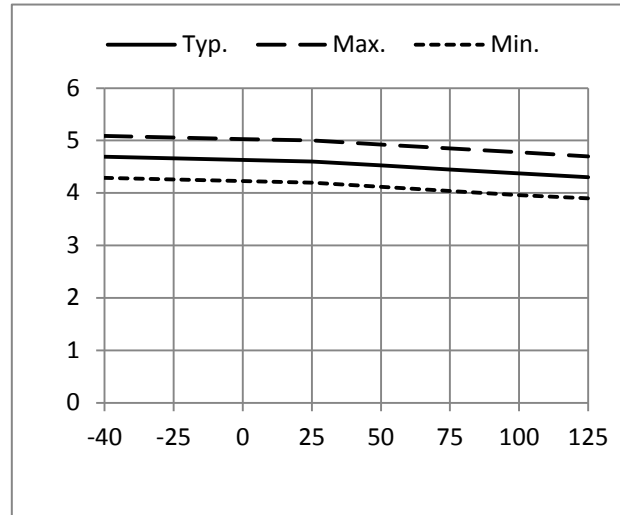

Figure 6B V_{BS} Undervoltage Threshold(-) vs Temperature

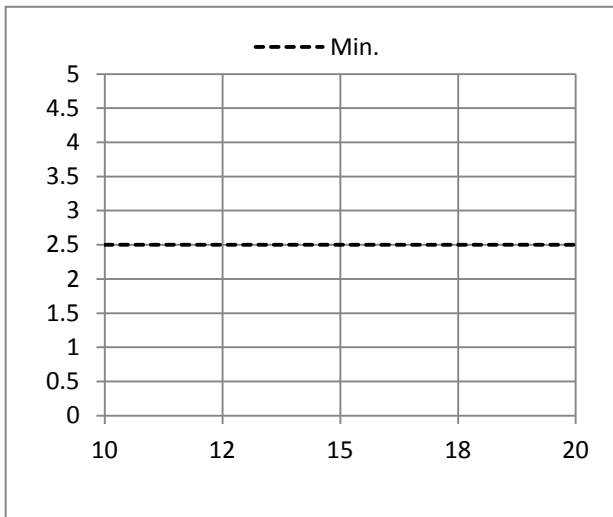

Figure 7A Logic "1" Input Voltage vs Supply Voltage

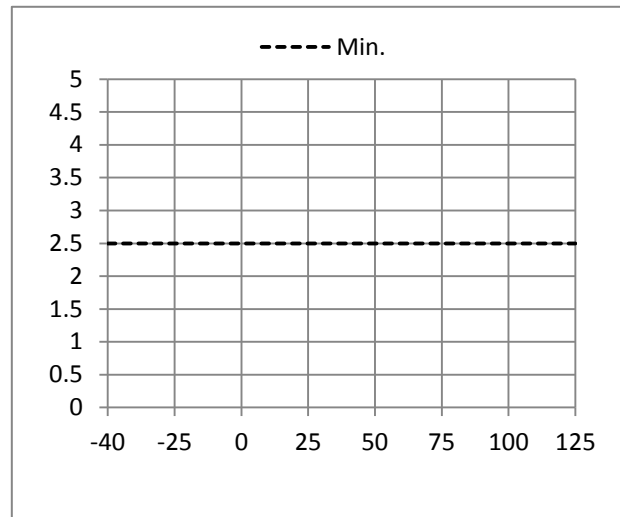

Figure 7B Logic "1" Input Voltage vs Temperature

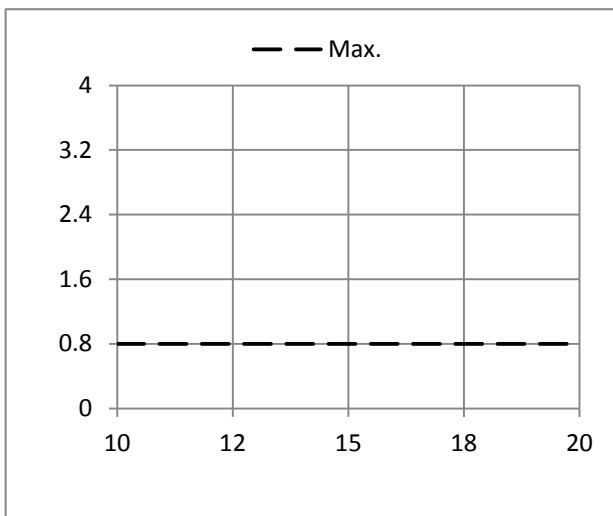

Figure 8A Logic "0" Input Voltage vs Supply Voltage

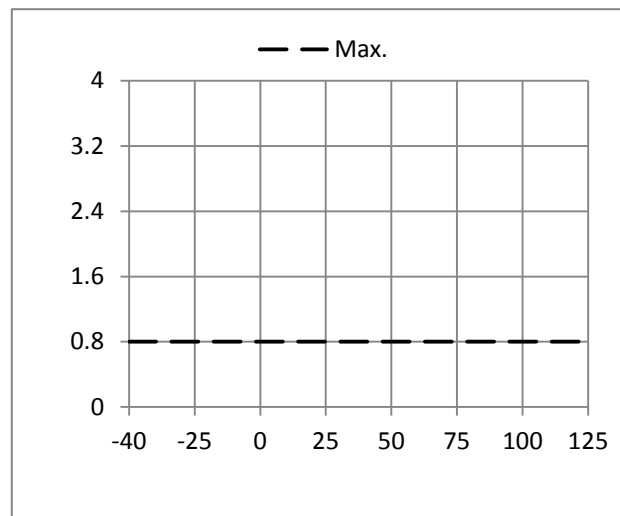

Figure 8B Logic "0" Input Voltage vs Temperature

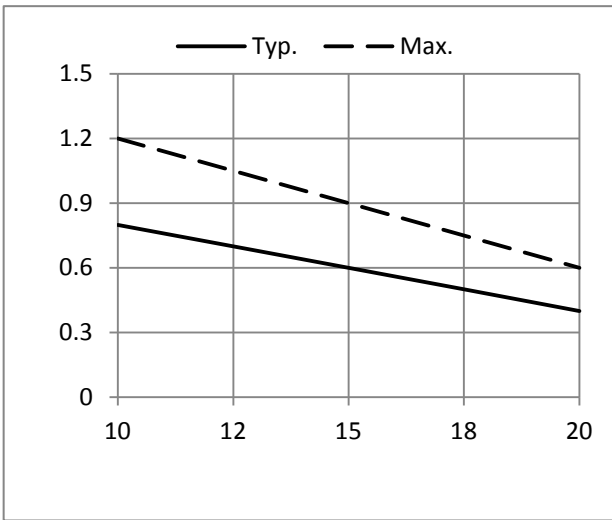

Figure 9A High Level Output Voltage vs Supply Voltage

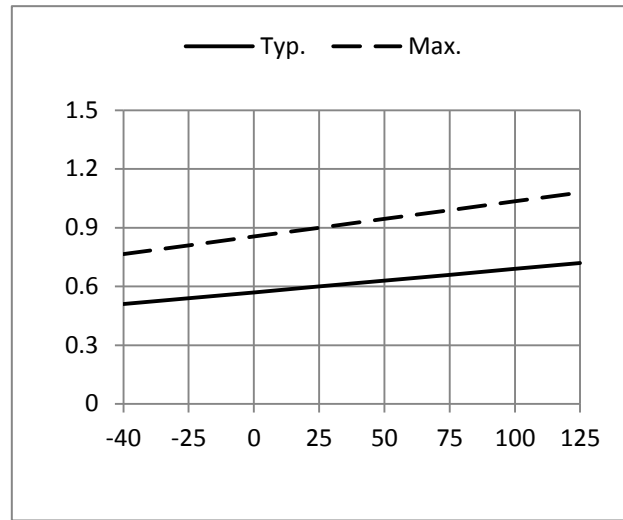

Figure 9B High Level Output Voltage vs Temperature

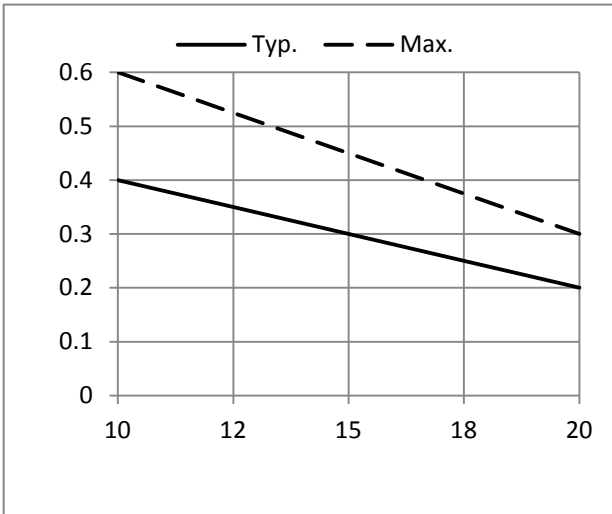

Figure 10A Low Level Output Voltage vs Supply Voltage

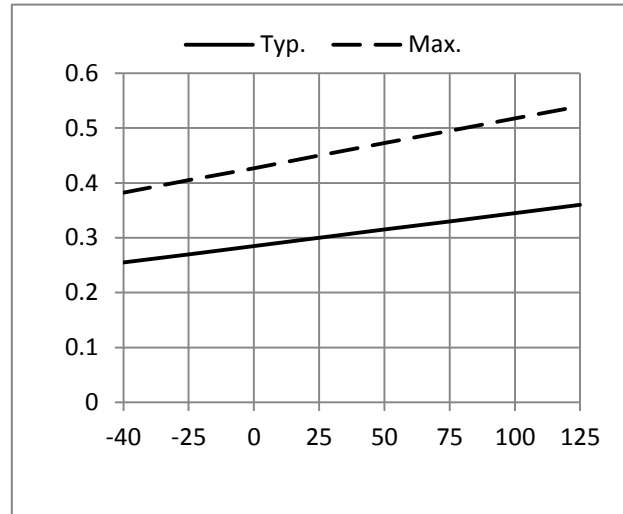

Figure 10B Low Level Output Voltage vs Temperature

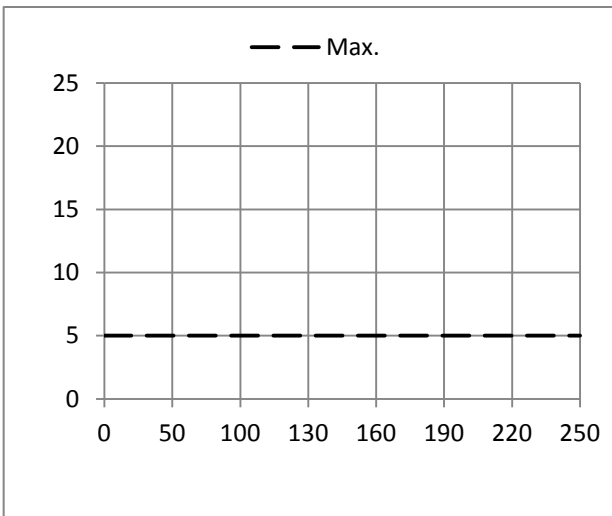

Figure 11A Offset Supply Current vs Voltage

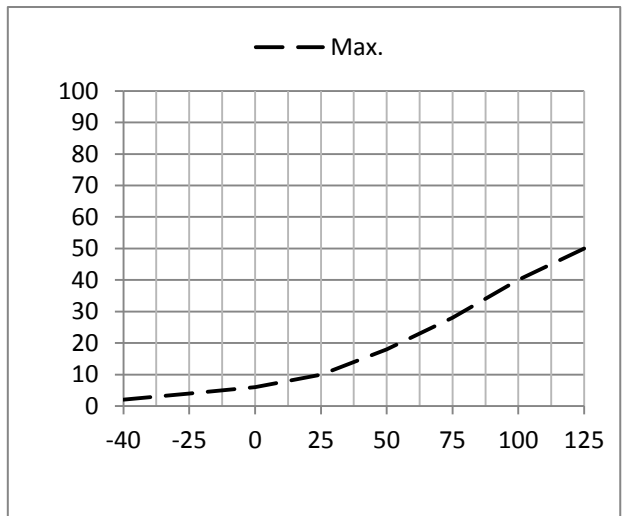

Figure 11B Offset Supply Current vs Temperature

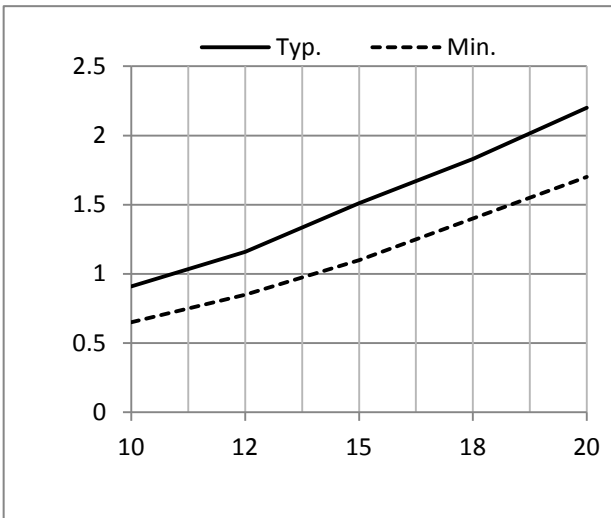

Figure 12A Output Source Current vs Supply Voltage

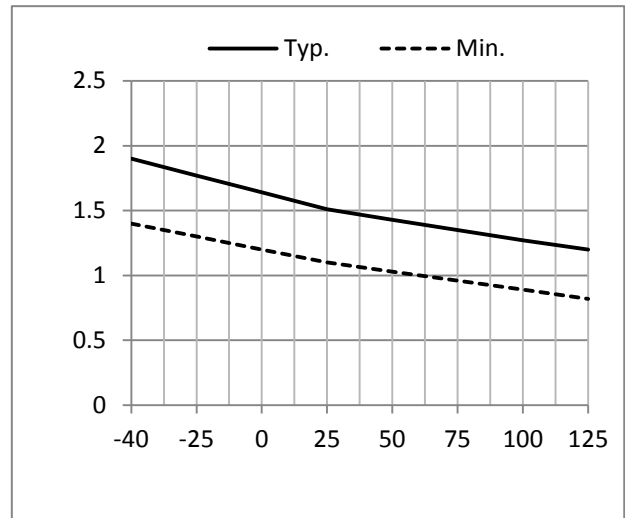

Figure 12B Output Source Current vs Temperature

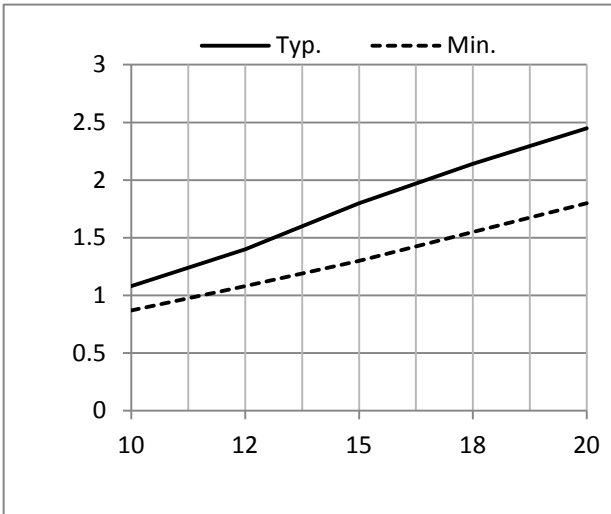

Figure 13A Output Sink Current vs Supply Voltage

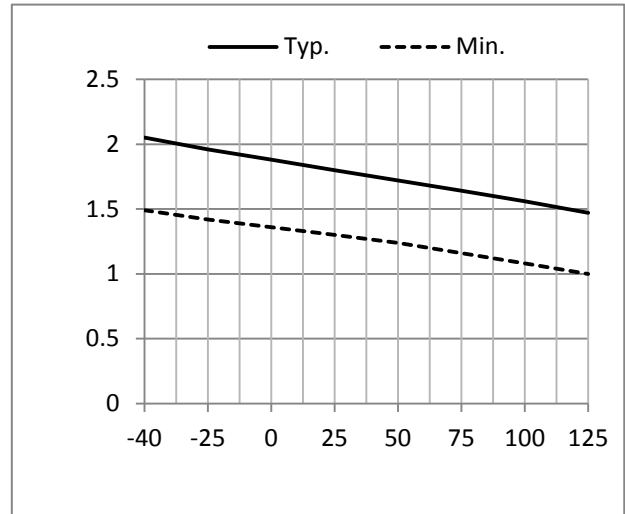

Figure 13B Output Sink Current vs Temperature

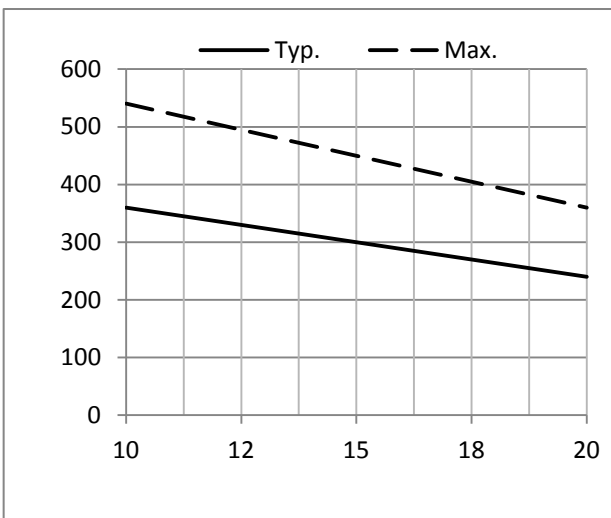

Figure 14A Turn On Time vs Supply Voltage

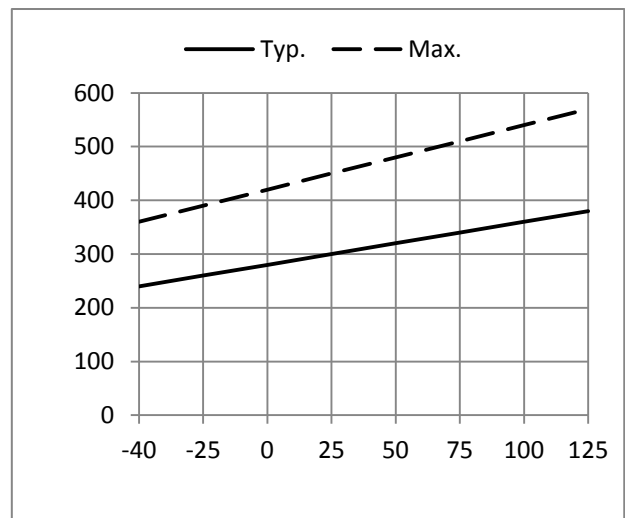

Figure 14B Turn On Time vs Temperature

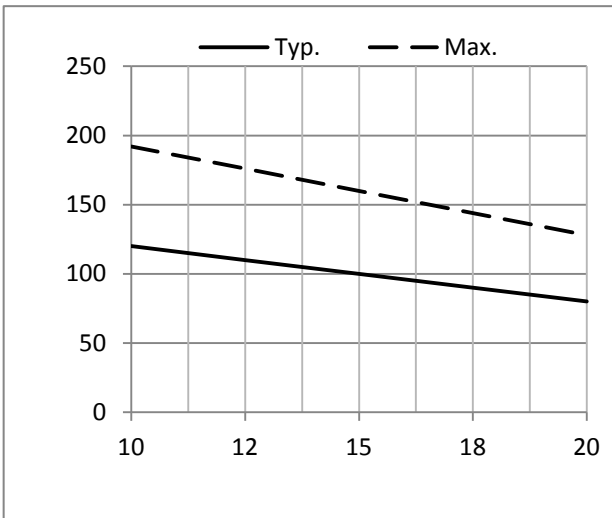

Figure 15A Turn Off Time vs Supply Voltage

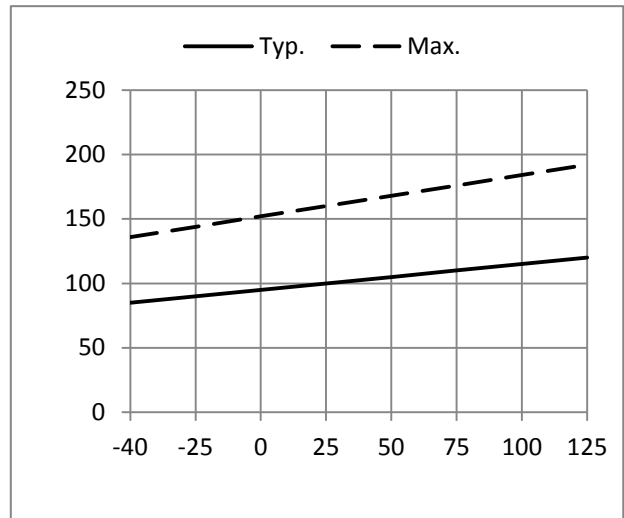

Figure 15B Turn Off Time vs Temperature

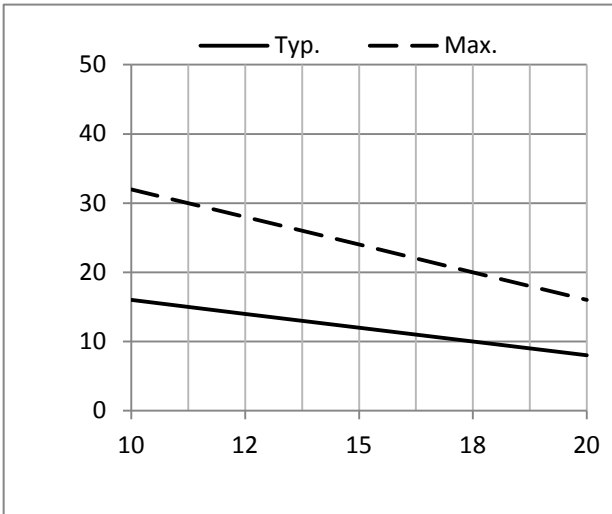

Figure 16A Turn On Rise Time vs Supply Voltage

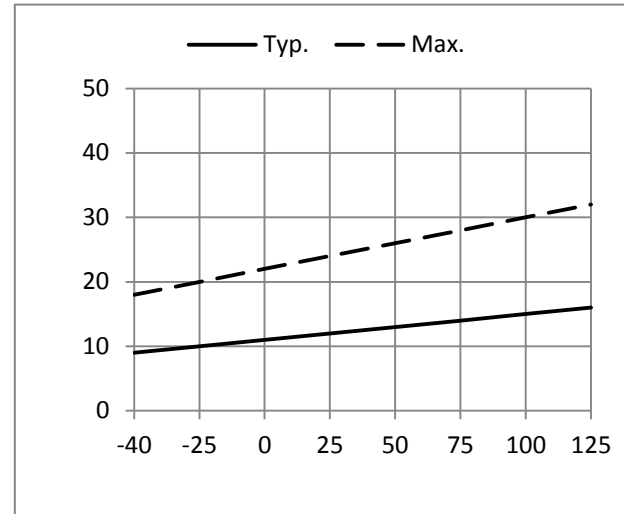

Figure 16B Turn On Rise Time vs Temperature

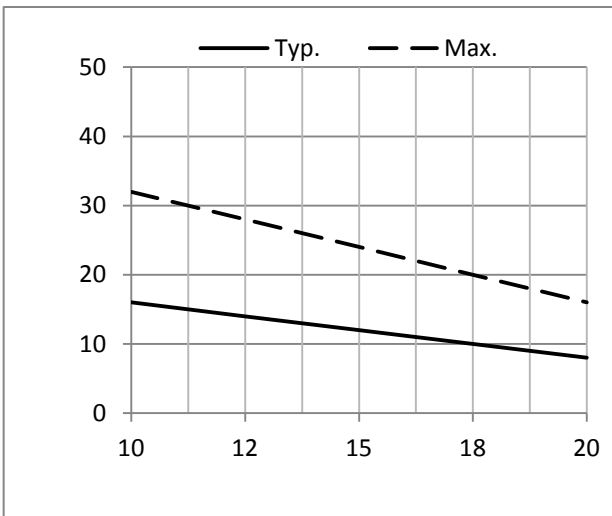

Figure 17A Turn Off Fall Time vs Supply Voltage

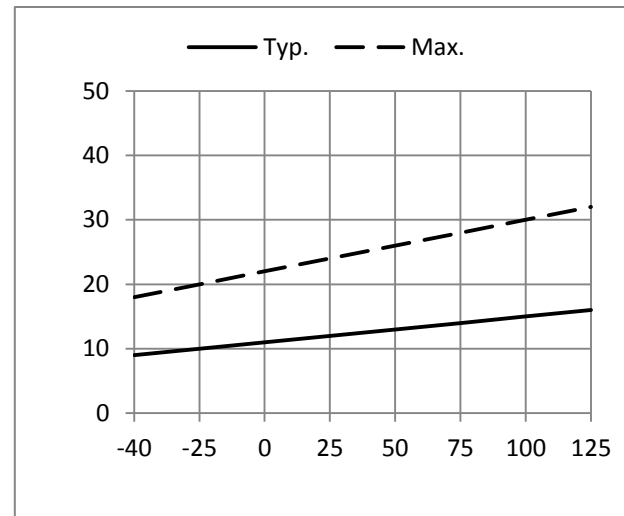

Figure 17B Turn Off Fall Time vs Temperature

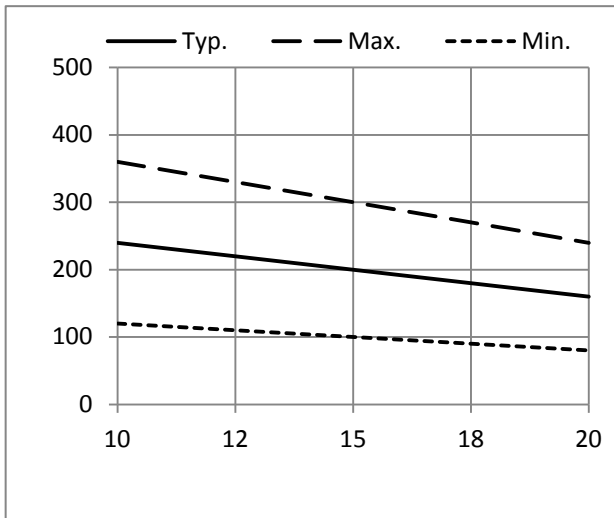

Figure 18A Dead Time vs Supply Voltage

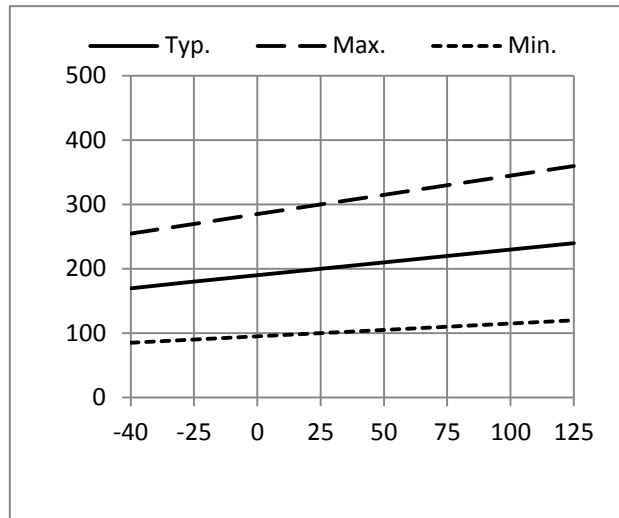

Figure 18B Deadtime Time vs Temperature

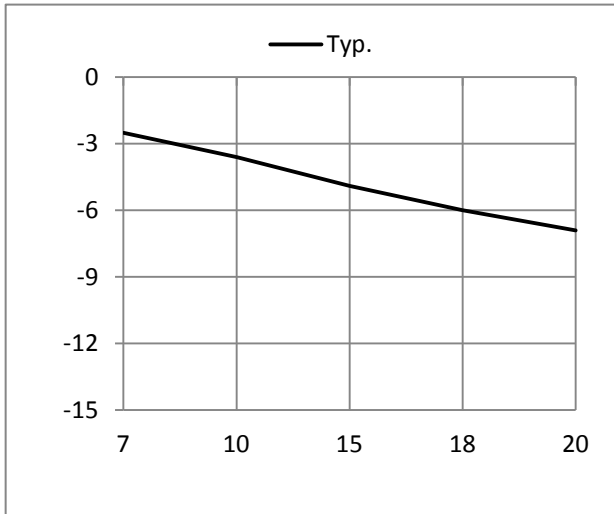

Figure 19A V_S Negative offset vs Supply Voltage

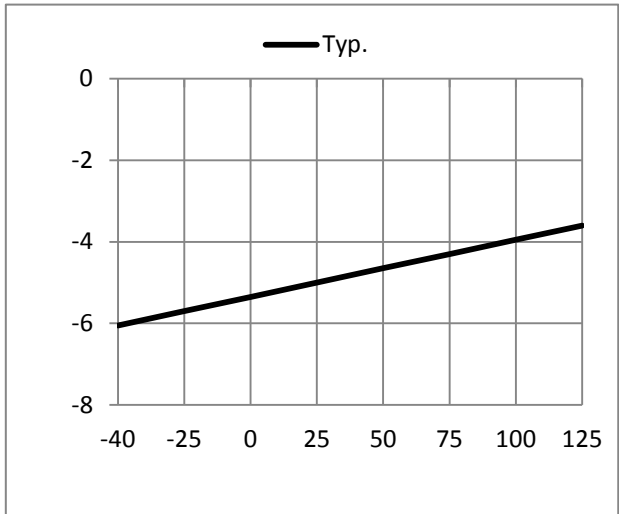
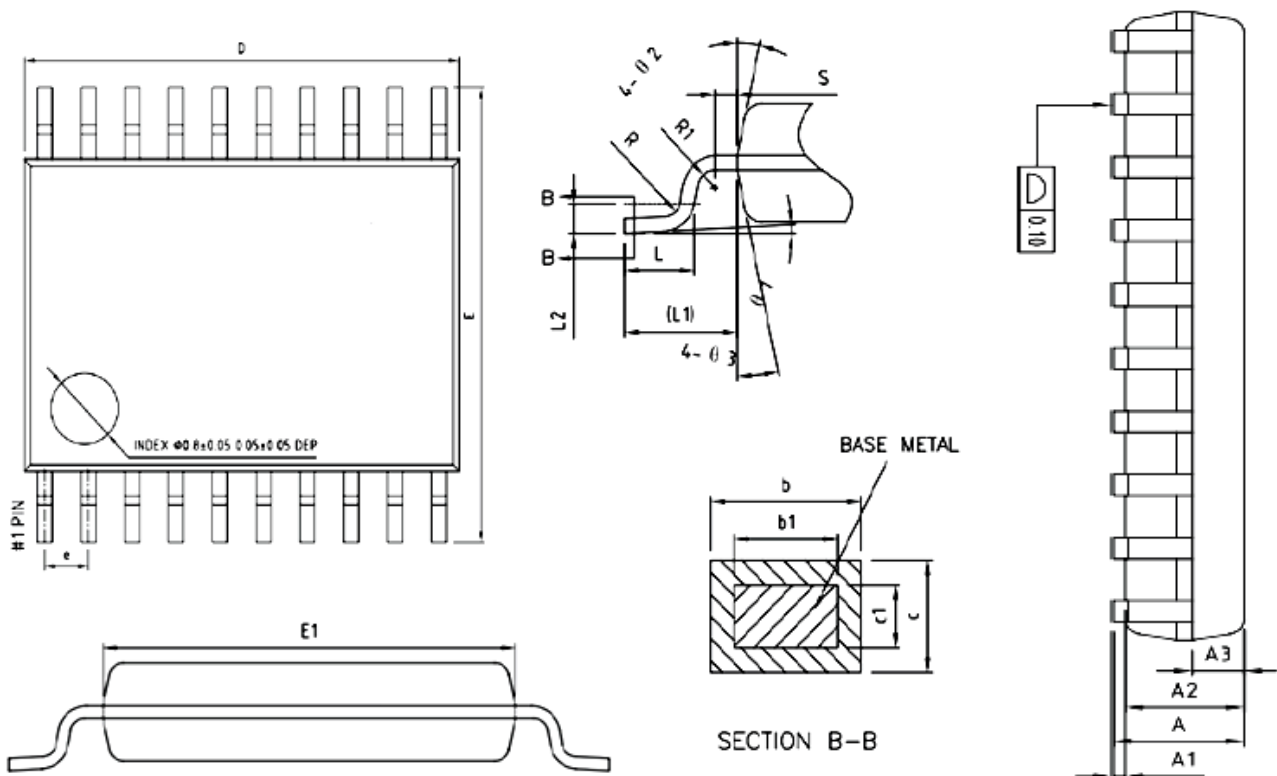

Figure 19B V_S Negative offset vs Temperature

Case outlines

	MIN	NOM	MAX
A	—	—	1.20
A1	0.05	—	0.15
A2	0.80	1.00	1.05
b	0.19	—	0.30
b1	0.19	0.22	0.25
c	0.09	—	0.20
c1	0.09	—	0.16
D	6.40	6.50	6.60
E	6.20	6.40	6.60
E1	4.30	4.40	4.50
e	0.65BSC		
L	0.45	0.60	0.75
L1	1.00BSC		

20 Lead TSSOP

Part Number	Package Type	Marking ID	Package Method	Quantity
FD6288T	TSSOP20	FD6288T	Tape&Reel	3000

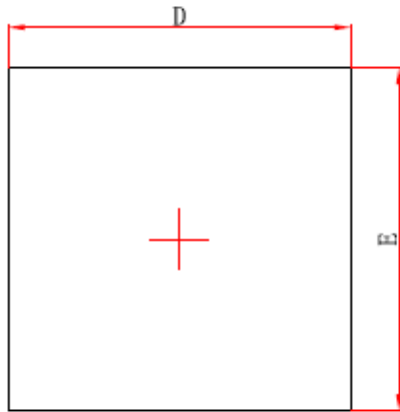
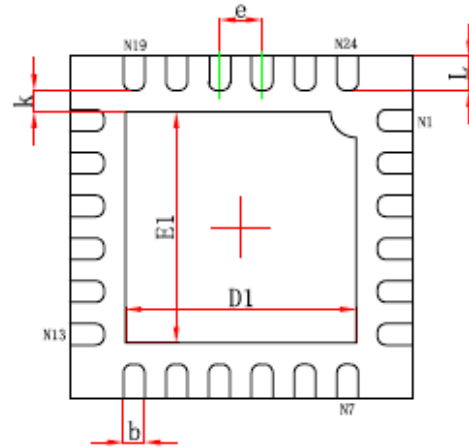
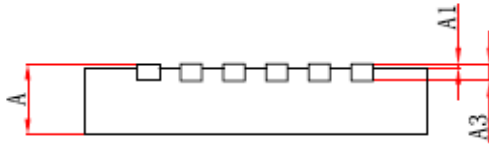
Top View

Bottom View

Side View

Symbol	Dimensions with mm		Dimensions with inch	
	Min.	Max.	Min.	Max.
A	0.700/0.800	0.800/0.900	0.028/0.031	0.0031/0.0035
A1	0.000	0.050	0.000	0.002
A3	0.203REF		0.008REF	
D	3.924	4.076	0.154	0.160
E	3.924	4.076	0.154	0.160
D1	2.600	2.800	0.102	0.110
E1	2.600	2.800	0.102	0.110
K	0.200MN		0.008MN	
B	0.200	0.300	0.008	0.012
E	0.500TYP		0.020TYP	
L	0.324	0.476	0.013	0.019

24 Lead QFN

Part Number	Package Type	Marking ID	Package Method	Quantity
FD6288Q	QFN24	FD6288Q	Tape&Reel	3000

Copyright Notice

Copyright by Fortior Technology (Shenzhen) Co., Ltd. All Rights Reserved.

Right to make changes —Fortior Technology (Shenzhen) Co., Ltd reserves the right to make changes in the products - including circuits, standard cells, and/or software - described or contained herein in order to improve design and/or performance. The information contained in this manual is provided for the general use by our customers. Our customers should be aware that the personal computer field is the subject of many patents. Our customers should ensure that they take appropriate action so that their use of our products does not infringe upon any patents. It is the policy of Fortior Technology (Shenzhen) Co., Ltd. to respect the valid patent rights of third parties and not to infringe upon or assist others to infringe upon such rights.

This manual is copyrighted by Fortior Technology (Shenzhen) Co., Ltd. You may not reproduce, transmit, transcribe, store in a retrieval system, or translate into any language, in any form or by any means, electronic, mechanical, magnetic, optical, chemical, manual, or otherwise, any part of this publication without the expressly written permission from Fortior Technology (Shenzhen) Co., Ltd.

Fortior Technology (Shenzhen) Co.,Ltd.

Room203, 2/F, Building No.11,Keji Central Road2,
Software Park, High-Tech Industrial Park, Shenzhen, P.R. China 518057
Tel: 0755-26867710
Fax: 0755-26867715
URL: <http://www.fortiortech.com>

Contained herein

Copyright by Fortior Technology (Shenzhen) Co., Ltd all rights reserved.