

P-Channel Enhancement MOSFET

■ Features

- Ultra low on-resistance.
- P-Channel MOSFET.
- SOT-23 Footprint.
- Low profile(<1.1mm).
- Available in tape and reel.
- Fast switching.

MARKING

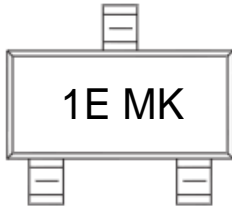

SOT - 23

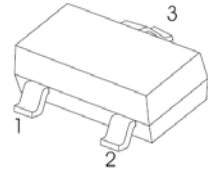

- 1. BASE
- 2. EMITTER
- 3. COLLECTOR

■ Absolute Maximum Ratings Ta = 25°C

Parameter	Symbol	Rating	Unit
Drain-Source Voltage	V _{DS}	-20	V
Gate-Source Voltage	V _{GS}	±12	
Continuous Drain Current V _{GS} =4.5V @ TA=25°C	I _D	-3.7	A
Continuous Drain Current V _{GS} =4.5V@ TA=70°C		-2.2	
Pulsed Drain Current a		I _{DM}	
Power Dissipation @ TA=25°C	P _D	1.3	W
Power Dissipation @ TA=70°C		0.8	
Single Pulse Avalanche Energy b	E _{AS}	11	mJ
Thermal Resistance.Junction- to-Ambient	R _{thJA}	100	°C/W
Linera Derating Factor		0.01	W/°C
Junction Temperature	T _J	150	°C
Junction and Storage Temperature Range	T _{stg}	-55 to 150	

Notes:

a.Repetitive Rating :Pulse width limited by maximum junction temperature

b.Starting T_J=25°C, L=1.65mH, R_G=25Ω, I_{AS}=-3.7A

P-Channel Enhancement MOSFET
■ Electrical Characteristics Ta = 25°C

Parameter	Symbol	Test conditions	Min	Typ	Max	Unit
Drain-source Breakdown voltage	V _{DSS}	I _D = -250 μA, V _{GS} = 0V	-20			V
Zero Gate Voltage Drain Current	I _{DSS}	V _{DS} = -20 V, V _{GS} = 0V			-1.0	μA
		V _{DS} = -20 V, V _{GS} = 0V, T _J = 70°C			-25	
Gate-source leakage	I _{GSS}	V _{GS} = ±12V			±100	nA
Gate threshold voltage	V _{GS(th)}	V _{DS} = V _{GS} , I _D = -250 μA	-0.40	-0.55	-0.95	V
Static drain-source on- resistance	R _{DS(on)}	I _D = -3.7A, V _{GS} = -4.5V		0.050	0.065	Ω
		I _D = -3.1A, V _{GS} = -2.5V		0.080	0.135	
Forward Transconductance	g _{fs}	V _{DS} = -10 V, I _D = -3.7 A	6.0			S
Input capacitance	C _{iss}	V _{DS} = -10 V, V _{GS} = 0 V, f = 1MHz		633		pF
Output capacitance	C _{oss}			145		
Reverse transfer capacitance	C _{rss}			110		
Total Gate Charge	Q _g	V _{DS} = -10V, V _{GS} = -5.0 V, I _D = -3.7 A		8.0	12	nC
Gate-Source Charge	Q _{gs}			1.2	1.8	
Gate-Drain Charge	Q _{gd}			2.8	4.2	
Turn-on delay time	t _{d(on)}	I _D = -3.7 A, V _{DD} = -10 V, R _D = 2.7 Ω R _G = 89 Ω		350		ns
Rise time	t _r			48		
Turn-off delay time	t _{d(off)}			588		
Fall time	t _f			381		
Reverse recovery time	t _{rr}	T _J = 25°C, I _F = -1.0 A, di / dt = -100 A / μs *2		29	43	ns
Reverse recovery charge	Q _{rr}			11	17	nC
Continuous source current	I _S	MOSFET symbol showing the integral reverse p-n junction diode			-1.3	A
Pulsed source current *1	I _{SM}				-22	
Diode forward voltage	V _{SD}	T _J = 25°C, V _{GS} = 0 V, I _S = -1.0 A *2			-1.2	V

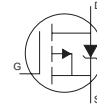

*1 Repetitive rating; pulse width limited by max. junction temperature.

* 2 Pulse width ≤ 400 μs, Duty cycle ≤ 2%

■ Typical Characteristics

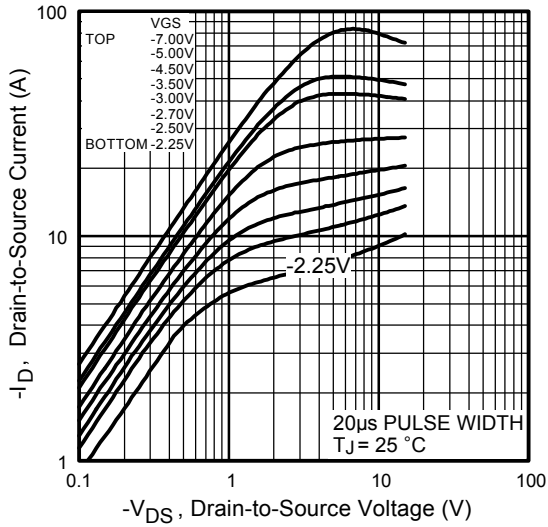

Fig 1. Typical Output Characteristics

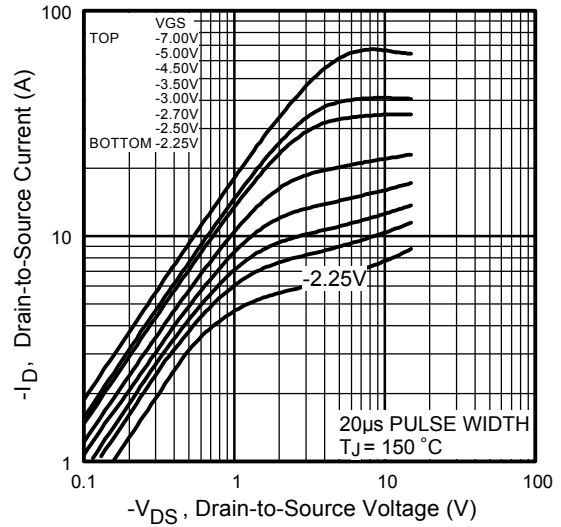

Fig 2. Typical Output Characteristics

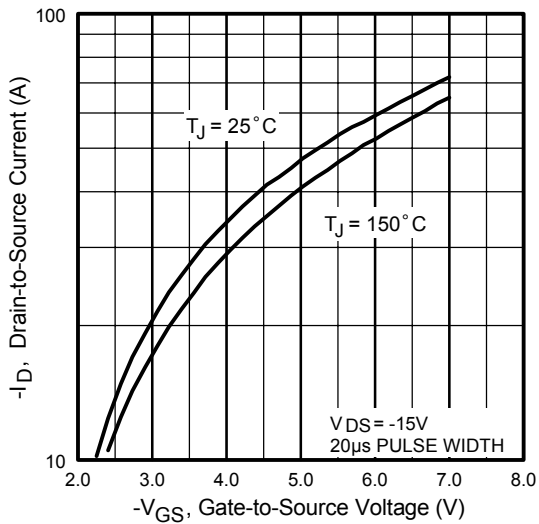

Fig 3. Typical Transfer Characteristics

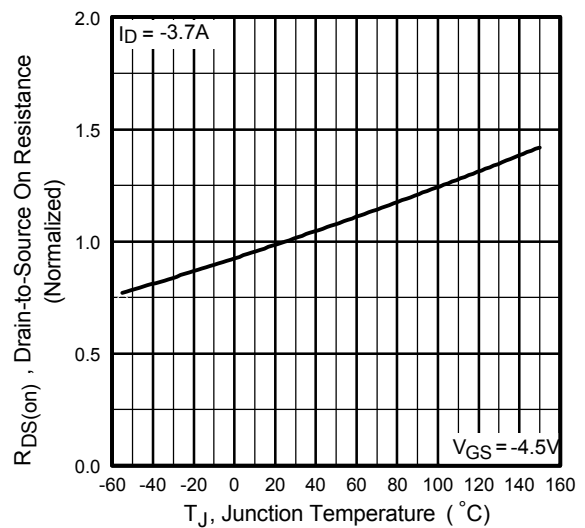

Fig 4. Normalized On-Resistance

■ Typical Characteristics

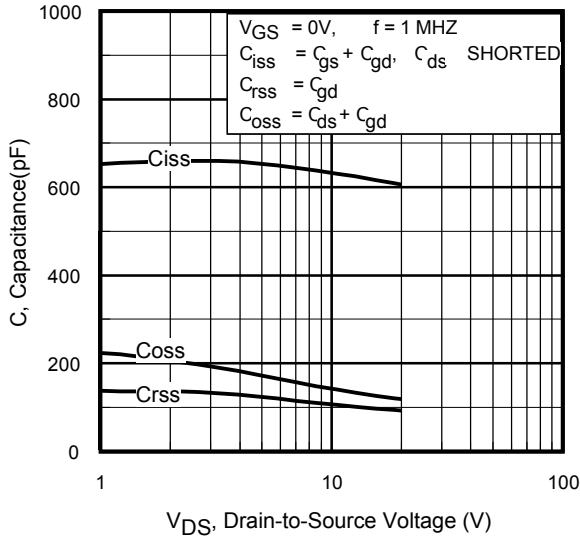

Fig 5. Typical Capacitance Vs. Drain-to-Source Voltage

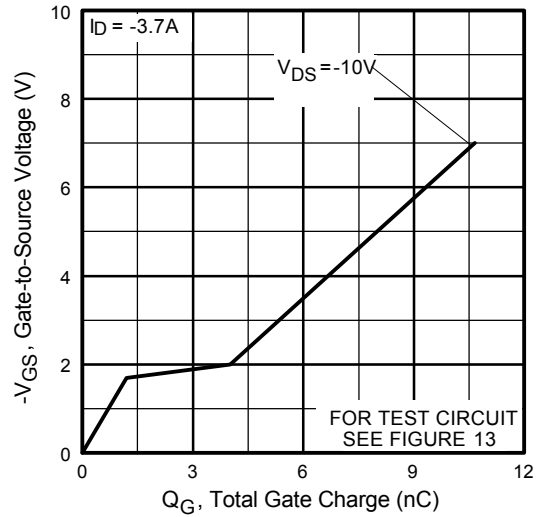

Fig 6. Typical Gate Charge Vs. Gate-to-Source Voltage

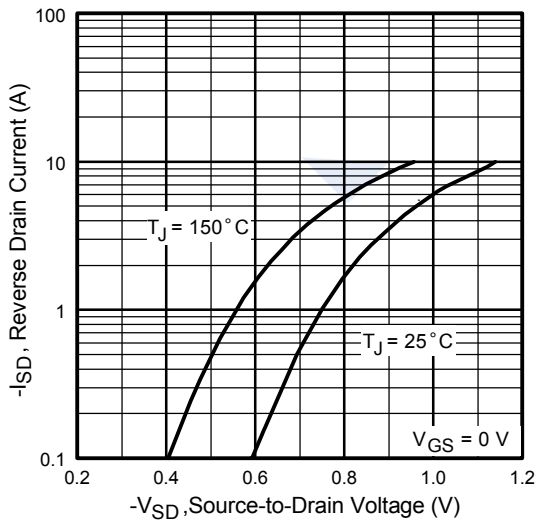

Fig 7. Typical Source-Drain Diode Forward Voltage

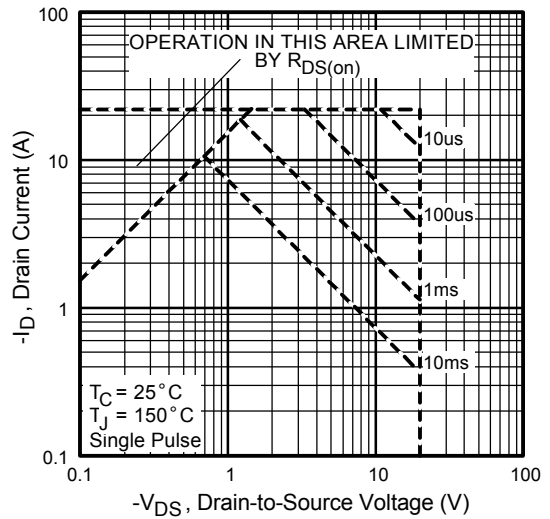

Fig 8. Maximum Safe Operating Area

■ Typical Characteristics

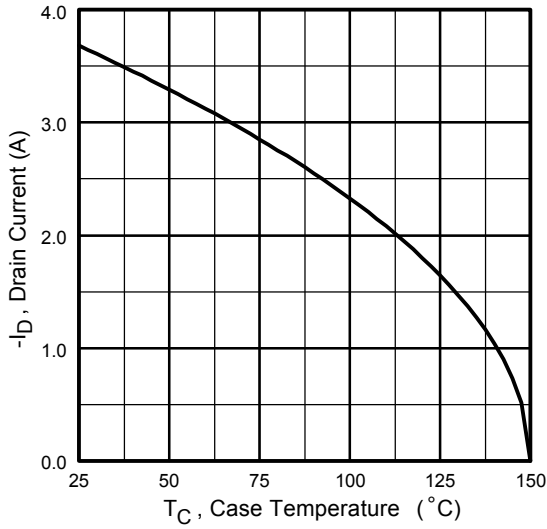

Fig 9. Maximum Drain Current Vs. Case Temperature

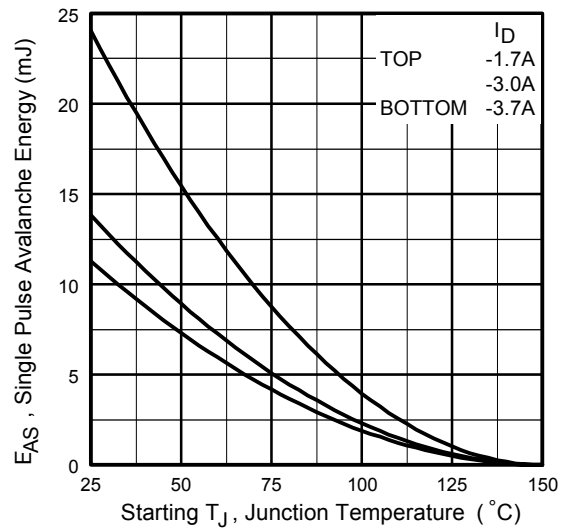

Fig 10. Maximum Avalanche Energy Vs. Drain Current

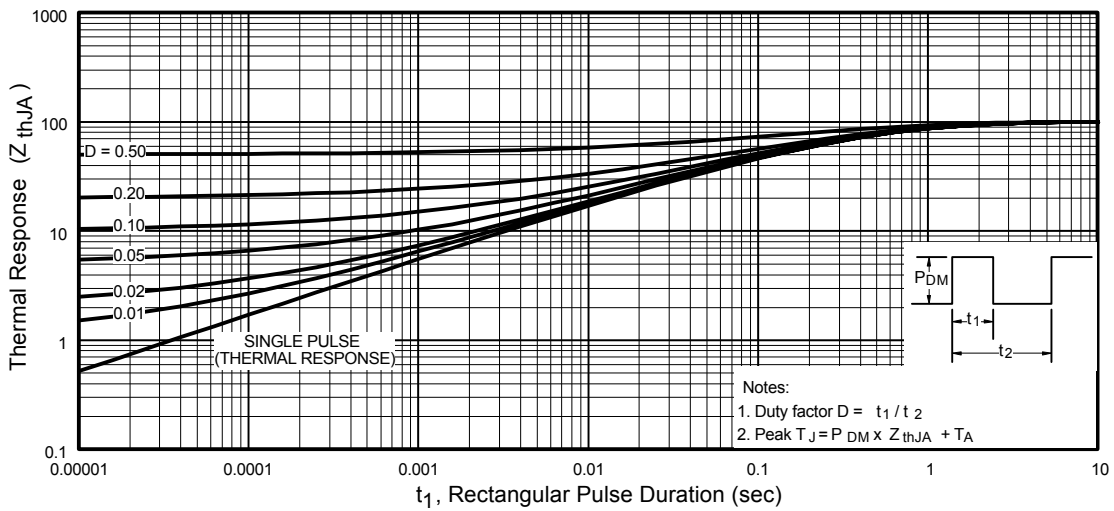

Fig 11. Maximum Effective Transient Thermal Impedance, Junction-to-Ambient

■ Typical Characteristics

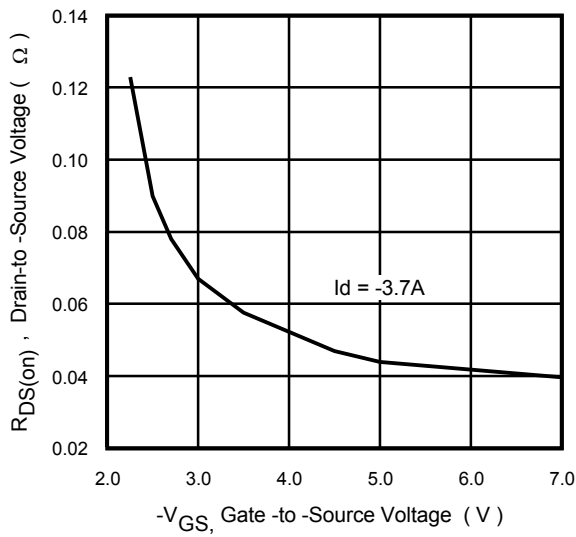

Fig 12. Typical On-Resistance Vs. Gate Voltage

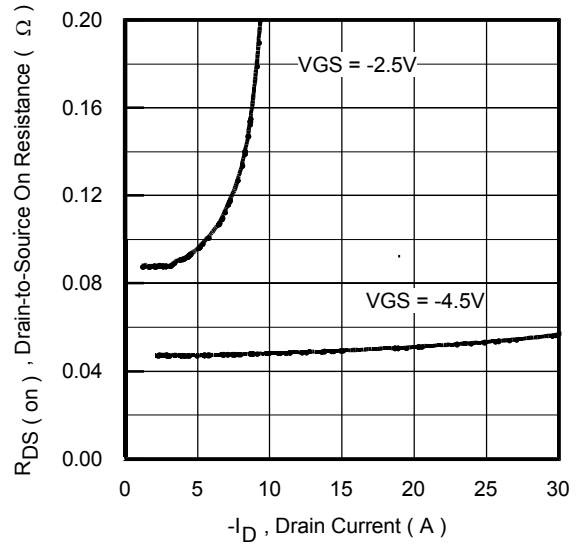
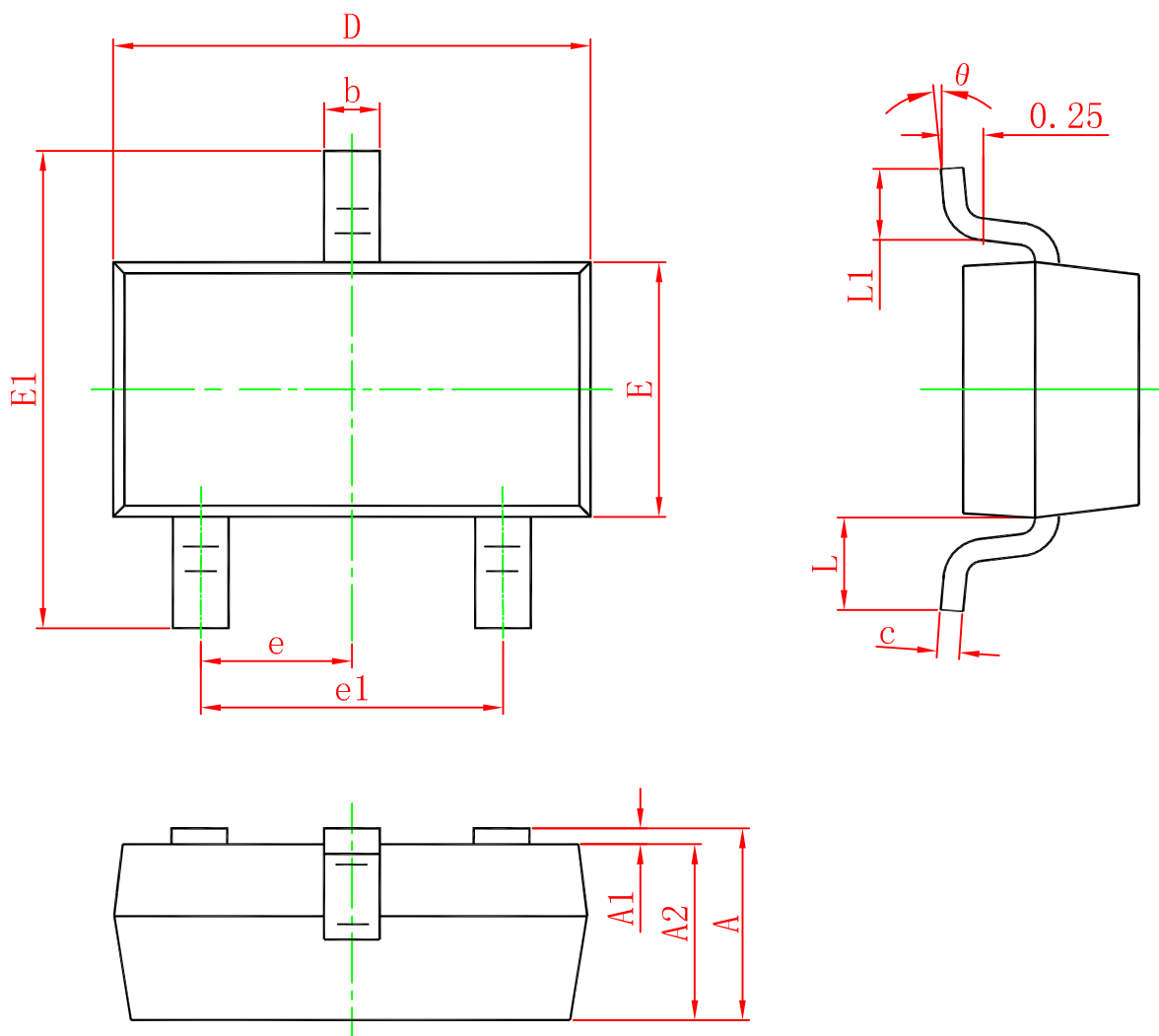

Fig 13. Typical On-Resistance Vs. Drain Current

P-Channel Enhancement MOSFET

SOT-23 PACKAGE OUTLINE DIMENSIONS



Symbol	Dimensions In Millimeters		Dimensions In Inches	
	Min.	Max.	Min.	Max.
A	0.900	1.150	0.035	0.045
A1	0.000	0.100	0.000	0.004
A2	0.900	1.050	0.035	0.041
b	0.300	0.500	0.012	0.020
c	0.080	0.150	0.003	0.006
D	2.800	3.000	0.110	0.118
E	1.200	1.400	0.047	0.055
E1	2.250	2.550	0.089	0.100
e	0.950 TYP.		0.037 TYP.	
e1	1.800	2.000	0.071	0.079
L	0.550 REF.		0.022 REF.	
L1	0.300	0.500	0.012	0.020
θ	0°	8°	0°	8°