



# -5V/-12V/-15V or Adjustable, High-Efficiency, Low IQ DC-DC Inverters

MAX764/MAX765/MAX766

## General Description

The MAX764/MAX765/MAX766 inverting switching regulators are highly efficient over a wide range of load currents, delivering up to 1.5W. A unique, current-limited, pulse-frequency-modulated (PFM) control scheme combines the benefits of traditional PFM converters with the benefits of pulse-width-modulated (PWM) converters. Like PWM converters, the MAX764/MAX765/MAX766 are highly efficient at heavy loads. Yet because they are PFM devices, they use less than 120µA of supply current (vs. 2mA to 10mA for a PWM device).

The input voltage range is 3V to 16V. The output voltage is preset at -5V (MAX764), -12V (MAX765), or -15V (MAX766); it can also be adjusted from -1V to -16V using two external resistors (Dual Mode™). The maximum operating  $V_{IN} - V_{OUT}$  differential is 20V.

These devices use miniature external components; their high switching frequencies (up to 300kHz) allow for less than 5mm diameter surface-mount magnetics. A standard 47µH inductor is ideal for most applications, so no magnetics design is necessary.

An internal power MOSFET makes the MAX764/MAX765/MAX766 ideal for minimum component count, low- and medium-power applications. For increased output drive capability or higher output voltages, use the MAX774/MAX775/MAX776 or MAX1774, which drive an external power P-channel MOSFET for loads up to 5W.

## Applications

- LCD-Bias Generators
- Portable Instruments
- LAN Adapters
- Remote Data-Acquisition Systems
- Battery-Powered Applications

## Typical Operating Circuit

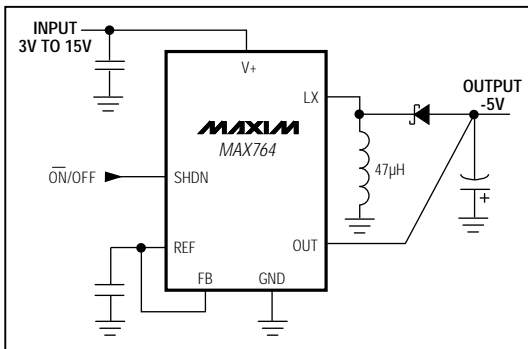

## Features

- ◆ High Efficiency for a Wide Range of Load Currents
- ◆ 250mA Output Current
- ◆ 120µA Max Supply Current
- ◆ 5µA Max Shutdown Current
- ◆ 3V to 16V Input Voltage Range
- ◆ -5V (MAX764), -12V (MAX765), -15V (MAX766), or Adjustable Output from -1V to -16V
- ◆ Current-Limited PFM Control Scheme
- ◆ 300kHz Switching Frequency
- ◆ Internal, P-Channel Power MOSFET

## Ordering Information

PART	TEMP. RANGE	PIN-PACKAGE
MAX764CPA	0°C to +70°C	8 Plastic DIP
MAX764CSA	0°C to +70°C	8 SO
MAX764C/D	0°C to +70°C	Dice*
MAX764EPA	-40°C to +85°C	8 Plastic DIP
MAX764ESA	-40°C to +85°C	8 SO
MAX764MJA	-55°C to +125°C	8 CERDIP**
MAX765CPA	0°C to +70°C	8 Plastic DIP
MAX765CSA	0°C to +70°C	8 SO
MAX765C/D	0°C to +70°C	Dice*
MAX765EPA	-40°C to +85°C	8 Plastic DIP
MAX765ESA	-40°C to +85°C	8 SO
MAX765MJA	-55°C to +125°C	8 CERDIP**

Ordering Information continued on last page.

\* Dice are tested at  $T_A = +25^\circ\text{C}$ , DC parameters only.

\*\*Contact factory for availability and processing to MIL-STD-883.

## Pin Configuration

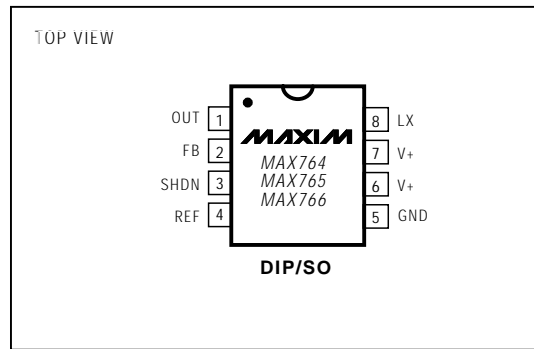

## -5V/-12V/-15V or Adjustable, High-Efficiency, Low IQ DC-DC Inverters

### ABSOLUTE MAXIMUM RATINGS

V+ to GND	-0.3V to +17V
OUT to GND	+0.5V to -17V
Maximum Differential (V+ to OUT)	+21V
REF, SHDN, FB to GND	-0.3V to (V+ + 0.3V)
LX to V+	+0.3V to -21V
LX Peak Current	1.5A
Continuous Power Dissipation (T <sub>A</sub> = +70°C)	
Plastic DIP (derate 9.09mW/°C above +70°C)	727mW
SO (derate 5.88mW/°C above +70°C)	471mW
CERDIP (derate 8.00mW/°C above +70°C)	640mW

### Operating Temperature Ranges

MAX76_C_A	0°C to +70°C
MAX76_E_A	-40°C to +85°C
MAX76_MJA	-55°C to +125°C

### Maximum Junction Temperatures

MAX76_C_A/E_A	+150°C
MAX76_MJA	+175°C
Storage Temperature Range	-65°C to +160°C
Lead Temperature (soldering, 10sec)	+300°C

Stresses beyond those listed under "Absolute Maximum Ratings" may cause permanent damage to the device. These are stress ratings only, and functional operation of the device at these or any other conditions beyond those indicated in the operational sections of the specifications is not implied. Exposure to absolute maximum rating conditions for extended periods may affect device reliability.

### ELECTRICAL CHARACTERISTICS

(V+ = 5V, I<sub>LOAD</sub> = 0mA, C<sub>REF</sub> = 0.1μF, T<sub>A</sub> = T<sub>MIN</sub> to T<sub>MAX</sub>, unless otherwise noted. Typical values are at T<sub>A</sub> = +25°C.)

PARAMETER	SYMBOL	CONDITIONS	MIN	TYP	MAX	UNITS
V+ Input Voltage Range	V+	MAX76_C/E	3.0		16.0	V
		MAX76_M	3.5			
Supply Current	I <sub>S</sub>	V+ = 16V, SHDN < 0.4V		90	120	μA
Shutdown Current	I <sub>SHDN</sub>	V+ = 16V, SHDN > 1.6V		2		
		V+ = 10V, SHDN > 1.6V		1	5	
FB Trip Point		3V ≤ V+ ≤ 16V	-10		10	mV
FB Input Current	I <sub>FB</sub>	MAX76_C			±50	nA
		MAX76_E			±70	
		MAX76_M			±90	
Output Current and Voltage (Note 1)	I <sub>OUT</sub>	MAX764, -4.8V ≤ V <sub>OUT</sub> ≤ 5.2V	150	260		mA
		MAX765C/E, -11.52V ≤ V <sub>OUT</sub> ≤ 12.48V	68	120		
		MAX765M, -11.52V ≤ V <sub>OUT</sub> ≤ 12.48V	50	120		
		MAX766, -14.40V ≤ V <sub>OUT</sub> ≤ -15.60V	35	105		
Reference Voltage	V <sub>REF</sub>	MAX76_C	1.4700	1.5	1.5300	V
		MAX76_E	1.4625	1.5	1.5375	
		MAX76_M	1.4550	1.5	1.5450	
REF Load Regulation		0μA ≤ I <sub>REF</sub> ≤ 100μA	MAX76_C/E	4	10	mV
			MAX76_M	4	15	
REF Line Regulation		3V ≤ V+ ≤ 16V		40	100	μV/V
Load Regulation (Note 2)		0mA ≤ I <sub>LOAD</sub> ≤ 100mA		0.008		%/mA
Line Regulation (Note 2)		4V ≤ V+ ≤ 6V		0.12		%/V
Efficiency (Note 2)		10mA ≤ I <sub>LOAD</sub> ≤ 100mA, V <sub>IN</sub> = 5V	V <sub>OUT</sub> = -5V	80		%
			V <sub>OUT</sub> = -15V	82		
SHDN Leakage Current		V+ = 16V, SHDN = 0V or V+			±1	μA
SHDN Input Voltage High	V <sub>IH</sub>	3V ≤ V+ ≤ 16V	1.6			V
SHDN Input Voltage Low	V <sub>IL</sub>	3V ≤ V+ ≤ 16V			0.4	V

# -5V/-12V/-15V or Adjustable, High-Efficiency, Low IQ DC-DC Inverters

MAX764/MAX765/MAX766

## ELECTRICAL CHARACTERISTICS (continued)

( $V_+ = 5V$ ,  $I_{LOAD} = 0mA$ ,  $C_{REF} = 0.1\mu F$ ,  $T_A = T_{MIN}$  to  $T_{MAX}$ , unless otherwise noted. Typical values are at  $T_A = +25^\circ C$ .)

PARAMETER	SYMBOL	CONDITIONS	MIN	TYP	MAX	UNITS
LX Leakage Current		$ V_{OUT}  + (V_+) \leq 20V$	MAX76_C		$\pm 5$	$\mu A$
			MAX76_E		$\pm 10$	
			MAX76_M		$\pm 30$	
LX On-Resistance		$ V_{OUT}  + (V_+) \geq 10V$		1.4	2.5	$\Omega$
Peak Current at LX	$I_{PEAK}$	$ V_{OUT}  + (V_+) \geq 10V$	0.5	0.75		A
Maximum Switch On-Time	$t_{ON}$		12	16	20	$\mu s$
Minimum Switch Off-Time	$t_{OFF}$		1.8	2.3	2.8	$\mu s$

**Note 1:** See Maximum Output Current vs. Supply Voltage graph in the *Typical Operating Characteristics*. Guarantees are based on correlation to switch on-time, switch off-time, on-resistance, and peak current rating.

**Note 2:** Circuit of Figure 2.

## Typical Operating Characteristics

( $V_+ = 5V$ ,  $V_{OUT} = -5V$ ,  $T_A = +25^\circ C$ , unless otherwise noted.)

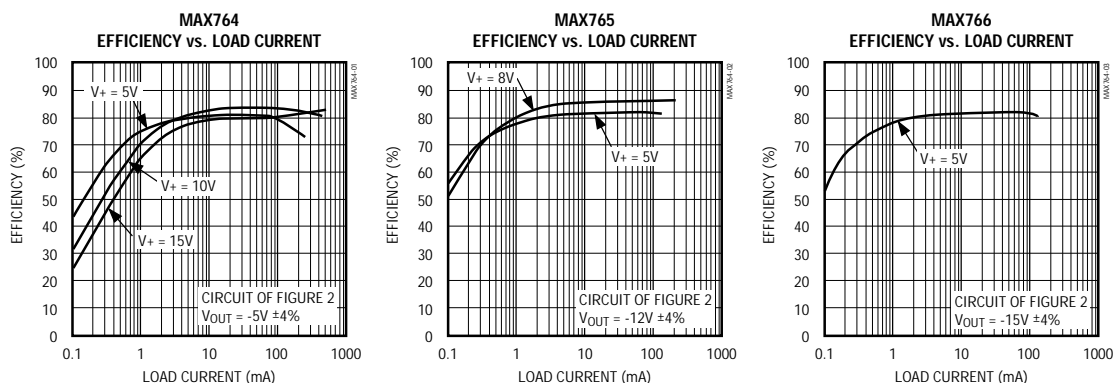

# -5V/-12V/-15V or Adjustable, High-Efficiency, Low IQ DC-DC Inverters

Typical Operating Characteristics (continued)  
 (V+ = 5V, VOUT = -5V, TA = +25°C, unless otherwise noted.)

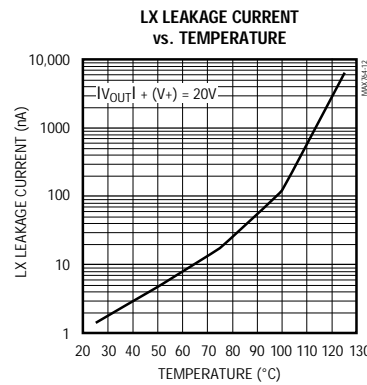
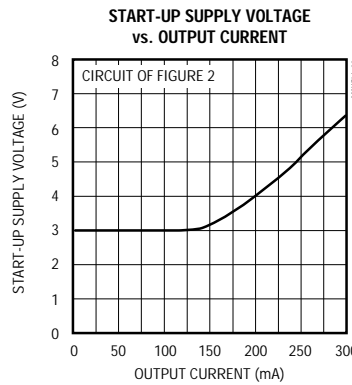
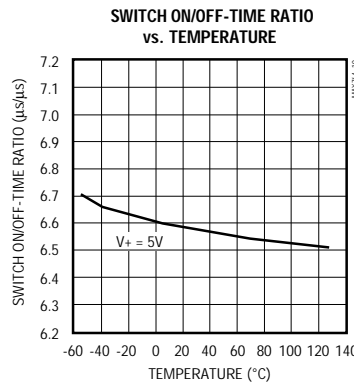
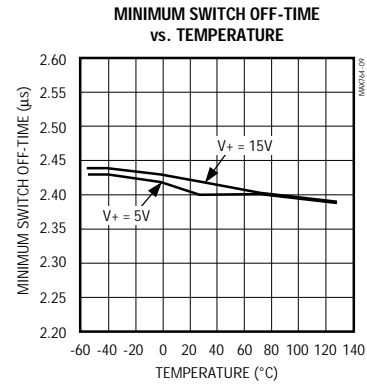
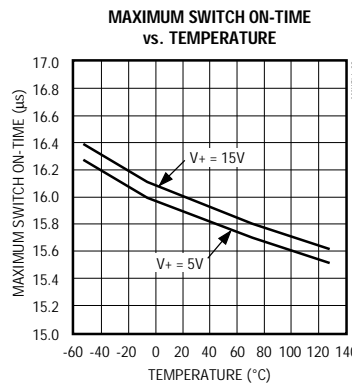
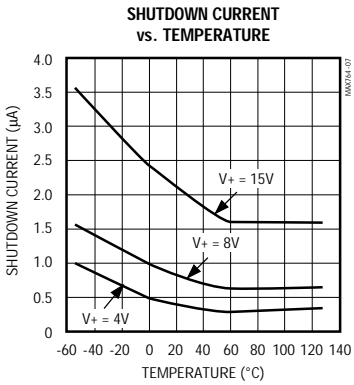
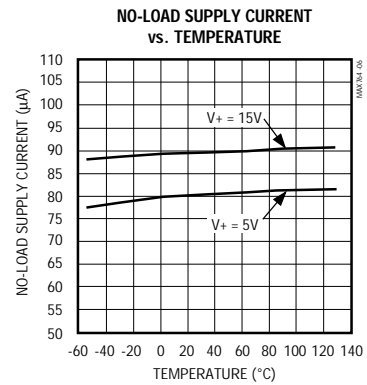
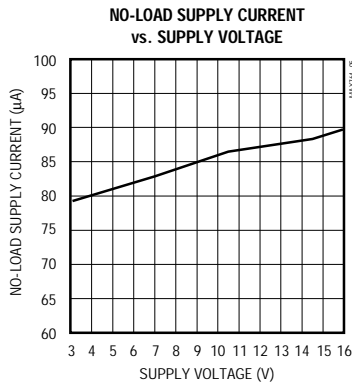
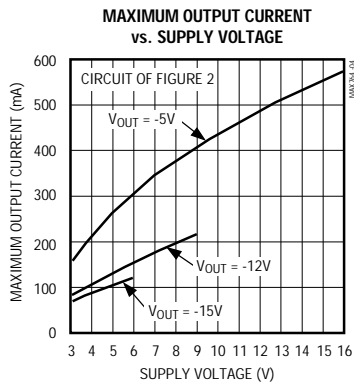

# -5V/-12V/-15V or Adjustable, High-Efficiency, Low IQ DC-DC Inverters

Typical Operating Characteristics (continued)  
( $V_+ = 5V$ ,  $V_{OUT} = -5V$ ,  $T_A = +25^\circ C$ , unless otherwise noted.)

MAX764/MAX765/MAX766

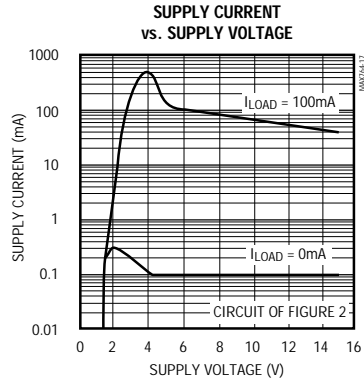
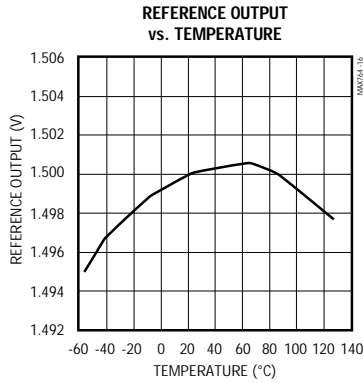
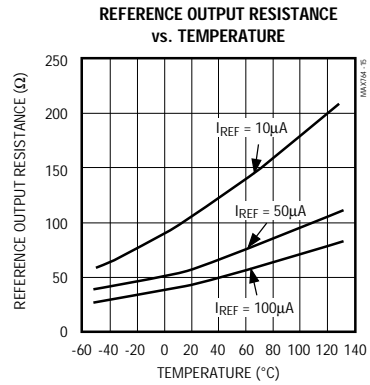
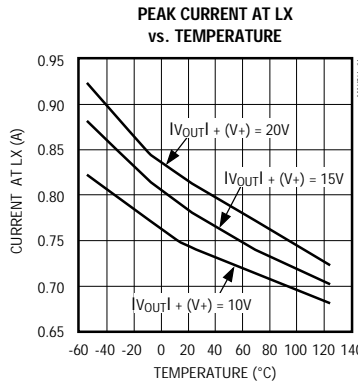
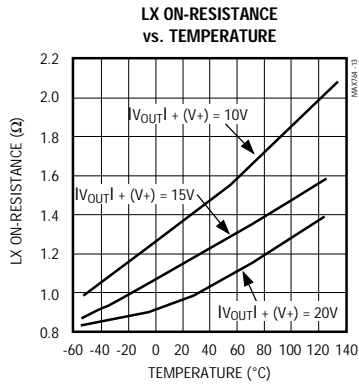

# -5V/-12V/-15V or Adjustable, High-Efficiency, Low IQ DC-DC Inverters

Typical Operating Characteristics (continued)  
( $V_+ = 5V$ ,  $V_{OUT} = -5V$ ,  $T_A = +25^\circ C$ , unless otherwise noted.)

**TIME TO ENTER/EXIT SHUTDOWN**

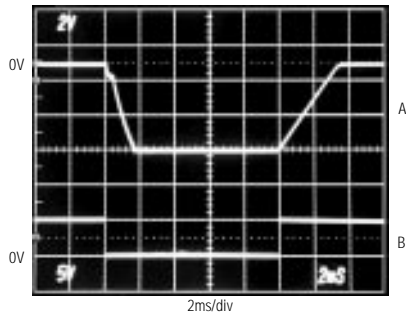

CIRCUIT OF FIGURE 2,  $V_+ = 5V$ ,  $I_{LOAD} = 100mA$ ,  $V_{OUT} = -5V$   
A:  $V_{OUT}$ , 2V/div  
B: SHUTDOWN PULSE, 0V TO 5V, 5V/div

**LOAD-TRANSIENT RESPONSE**

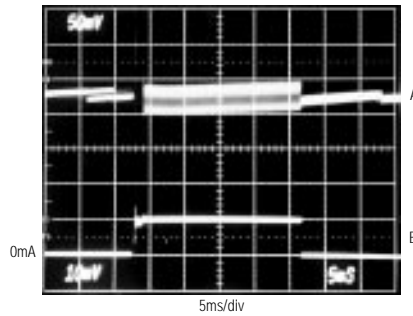

CIRCUIT OF FIGURE 2,  $V_+ = 5V$ ,  $V_{OUT} = -5V$   
A:  $V_{OUT}$ , 50mV/div, AC-COUPLED  
B:  $I_{LOAD}$ , 0mA TO 100mA, 100mA/div

**LINE-TRANSIENT RESPONSE**

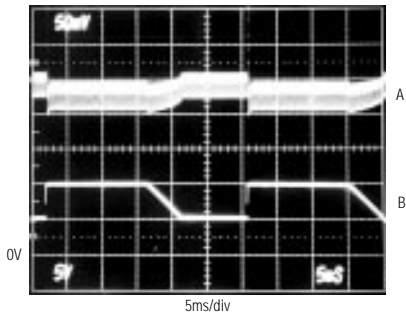

CIRCUIT OF FIGURE 2,  $V_{OUT} = -5V$ ,  $I_{LOAD} = 100mA$   
A:  $V_{OUT}$ , 50mV/div, AC-COUPLED  
B:  $V_+$ , 5V TO 10V, 5V/div

**DISCONTINUOUS CONDUCTION AT  
HALF AND FULL CURRENT LIMIT**

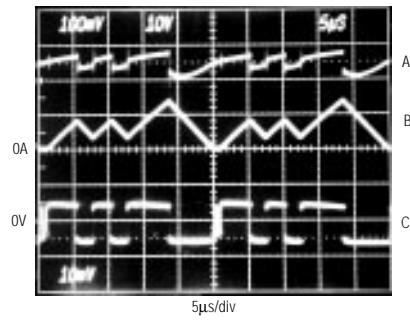

CIRCUIT OF FIGURE 2,  $V_+ = 5V$ ,  $V_{OUT} = -5V$ ,  $I_{LOAD} = 140mA$   
A: OUTPUT RIPPLE, 100mV/div  
B: INDUCTOR CURRENT, 500mA/div  
C: LX WAVEFORM, 10V/div

# -5V/-12V/-15V or Adjustable, High-Efficiency, Low IQ DC-DC Inverters

## Typical Operating Characteristics (continued)

(V+ = 5V, V<sub>OUT</sub> = -5V, T<sub>A</sub> = +25°C, unless otherwise noted.)

**DISCONTINUOUS CONDUCTION AT  
HALF CURRENT LIMIT**

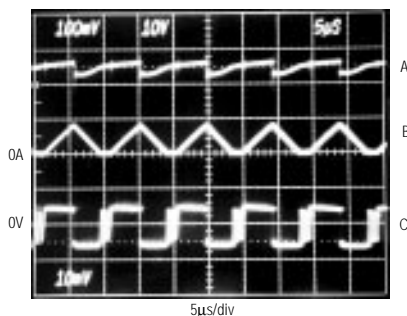

5µs/div  
CIRCUIT OF FIGURE 2, V+ = 5V, V<sub>OUT</sub> = -5V, I<sub>LOAD</sub> = 80mA  
A: OUTPUT RIPPLE, 100mV/div  
B: INDUCTOR CURRENT, 500mA/div  
C: LX WAVEFORM, 10V/div

**CONTINUOUS CONDUCTION AT  
FULL CURRENT LIMIT**

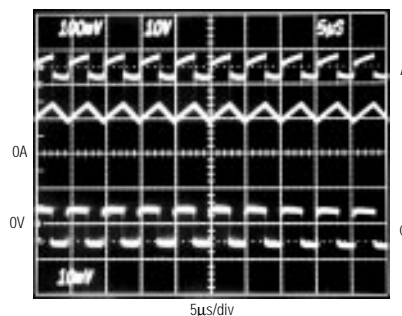

5µs/div  
CIRCUIT OF FIGURE 2, V+ = 5V, V<sub>OUT</sub> = -5V, I<sub>LOAD</sub> = 240mA  
A: OUTPUT RIPPLE, 100mV/div  
B: INDUCTOR CURRENT, 500mA/div  
C: LX WAVEFORM, 10V/div

MAX764/MAX765/MAX766

## Pin Description

PIN	NAME	FUNCTION
1	OUT	Sense Input for Fixed-Output Operation (V <sub>FB</sub> = V <sub>REF</sub> ). OUT must be connected to V <sub>OUT</sub> .
2	FB	Feedback Input. Connect FB to REF to use the internal voltage divider for a preset output. For adjustable-output operation, use an external voltage divider, as described in the section <i>Setting the Output Voltage</i> .
3	SHDN	Active-High Shutdown Input. With SHDN high, the part is in shutdown mode and the supply current is less than 5µA. Connect to ground for normal operation.
4	REF	1.5V Reference Output that can source 100µA for external loads. Bypass to ground with a 0.1µF capacitor.
5	GND	Ground
6, 7	V+	Positive Power-Supply Input. Must be tied together. <b>Place a 0.1µF input bypass capacitor as close to the V+ and GND pins as possible.</b>
8	LX	Drain of the Internal P-Channel Power MOSFET. LX has a peak current limit of 0.75A.





## -5V/-12V/-15V or Adjustable, High-Efficiency, Low IQ DC-DC Inverters

MAX764/MAX765/MAX766

switch is OFF), the range of input and output voltages is limited to a 21V absolute maximum differential voltage.

When output voltages more negative than -16V are required, substitute the MAX764/MAX765/MAX766 with Maxim's MAX774/MAX775/MAX776 or MAX1774, which use an external switch.

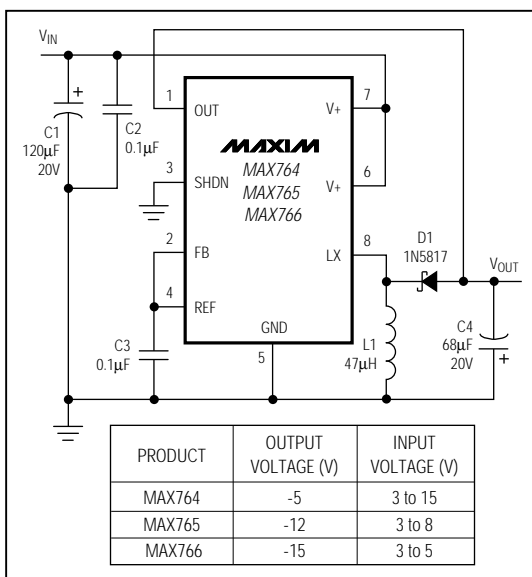

Figure 2. Fixed Output Voltage Operation

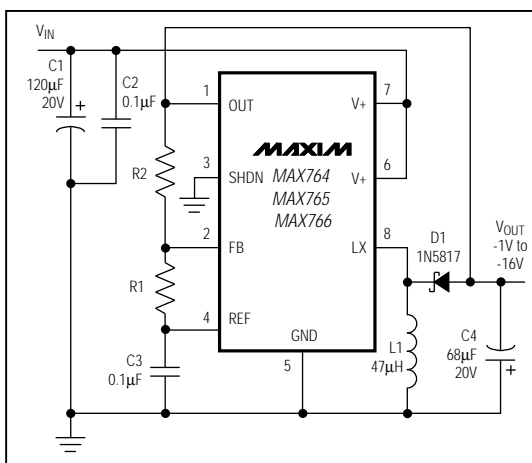

Figure 3. Adjustable Output Voltage Operation

### PFM Control Scheme

The MAX764/MAX765/MAX766 use a proprietary, current-limited PFM control scheme that blends the best features of PFM and PWM devices. It combines the ultra-low supply currents of traditional pulse-skipping PFM converters with the high full-load efficiencies of current-mode pulse-width modulation (PWM) converters. This control scheme allows the devices to achieve high efficiencies over a wide range of loads, while the current-sense function and high operating frequency allow the use of miniature external components.

As with traditional PFM converters, the internal power MOSFET is turned on when the voltage comparator senses that the output is out of regulation (Figure 1). However, unlike traditional PFM converters, switching is accomplished through the combination of a peak current limit and a pair of one-shots that set the maximum on-time (16µs) and minimum off-time (2.3µs) for the switch. Once off, the minimum off-time one-shot holds the switch off for 2.3µs. After this minimum time, the switch either 1) stays off if the output is in regulation, or 2) turns on again if the output is out of regulation.

The MAX764/MAX765/MAX766 limit the peak inductor current, which allows them to run in continuous-conduction mode and maintain high efficiency with heavy loads. (See the photo Continuous Conduction at Full Current Limit in the *Typical Operating Characteristics*.) This current-limiting feature is a key component of the control circuitry. Once turned on, the switch stays on until either 1) the maximum on-time one shot turns it off (16µs later), or 2) the current limit is reached.

To increase light-load efficiency, the current limit is set to half the peak current limit for the first two pulses. If those pulses bring the output voltage into regulation, the voltage comparator holds the MOSFET off and the current limit remains at half the peak current limit. If the output voltage is still out of regulation after two pulses, the current limit is raised to its 0.75A peak for the next pulse. (See the photo Discontinuous Conduction at Half and Full Current Limit in the *Typical Operating Characteristics*.)

### Shutdown Mode

When SHDN is high, the MAX764/MAX765/MAX766 enter a shutdown mode in which the supply current drops to less than 5µA. In this mode, the internal biasing circuitry (including the reference) is turned off and OUT discharges to ground. SHDN is a TTL/CMOS-logic level input. Connect SHDN to GND for normal operation. With a current-limited supply, power-up the device while unloaded or in shutdown mode (hold SHDN high until V+ exceeds 3.0V) to save power and reduce power-up current surges. (See the Supply Current vs. Supply Voltage graph in the *Typical Operating Characteristics*.)

## -5V/-12V/-15V or Adjustable, High-Efficiency, Low IQ DC-DC Inverters

### Modes of Operation

When delivering high output currents, the MAX764/MAX765/MAX766 operate in continuous-conduction mode. In this mode, current always flows in the inductor, and the control circuit adjusts the duty-cycle of the switch on a cycle-by-cycle basis to maintain regulation without exceeding the switch-current capability. This provides excellent load-transient response and high efficiency.

In discontinuous-conduction mode, current through the inductor starts at zero, rises to a peak value, then ramps down to zero on each cycle. Although efficiency is still excellent, the output ripple may increase slightly.

### Design Procedure

#### Setting the Output Voltage

The MAX764/MAX765/MAX766's output voltage can be adjusted from -1.0V to -16V using external resistors R1 and R2, configured as shown in Figure 3. For adjustable-output operation, select feedback resistor R1 = 150k $\Omega$ . R2 is given by:

$$R2 = (R1) \left| \frac{V_{OUT}}{V_{REF}} \right|$$

where VREF = 1.5V.

For fixed-output operation, tie FB to REF.

#### Inductor Selection

In both continuous- and discontinuous-conduction modes, practical inductor values range from 22 $\mu$ H to 68 $\mu$ H. If the inductor value is too low, the current in the coil will ramp up to a high level before the current-limit comparator can turn off the switch, wasting power and reducing efficiency. The maximum inductor value is not critical. A 47 $\mu$ H inductor is ideal for most applications.

For highest efficiency, use a coil with low DC resistance, preferably under 100m $\Omega$ . To minimize radiated noise, use a toroid, pot core, or shielded coil. Inductors with a ferrite core or equivalent are recommended. The inductor's incremental saturation-current rating should be greater than the 0.75A peak current limit. It is generally acceptable to bias the inductor into saturation by approximately 20% (the point where the inductance is 20% below the nominal value).

Table 1 lists inductor types and suppliers for various applications. The listed surface-mount inductors' efficiencies are nearly equivalent to those of the larger-size through-hole inductors.

### Diode Selection

The MAX764/MAX765/MAX766's high switching frequency demands a high-speed rectifier. Use a Schottky diode with a 0.75A average current rating, such as the 1N5817 or 1N5818. High leakage currents may make Schottky diodes inadequate for high-temperature and light-load applications. In these cases you can use high-speed silicon diodes, such as the MUR105 or the EC11FS1. At heavy loads and high temperatures, the benefits of a Schottky diode's low forward voltage may outweigh the disadvantages of its high leakage current.

### Capacitor Selection

#### Output Filter Capacitor

The primary criterion for selecting the output filter capacitor (C4) is low effective series resistance (ESR). The product of the inductor-current variation and the output filter capacitor's ESR determines the amplitude of the high-frequency ripple seen on the output voltage. A 68 $\mu$ F, 20V Sanyo OS-CON capacitor with ESR = 45m $\Omega$  (SA series) typically provides 50mV ripple when converting from 5V to -5V at 150mA.

Output filter capacitor ESR also affects efficiency. To obtain optimum performance, use a 68 $\mu$ F or larger, low-ESR capacitor with a voltage rating of at least 20V. The smallest low-ESR surface-mount tantalum capacitors currently available are from the Sprague 595D series. Sanyo OS-CON series organic semiconductors and AVX TPS series tantalum capacitors also exhibit very low ESR. OS-CON capacitors are particularly useful at low temperatures. Table 1 lists some suppliers of low-ESR capacitors.

For best results when using capacitors other than those suggested in Table 1 (or their equivalents), increase the output filter capacitor's size or use capacitors in parallel to reduce ESR.

#### Input Bypass Capacitor

The input bypass capacitor, C1, reduces peak currents drawn from the voltage source and reduces the amount of noise at the voltage source caused by the switching action of the MAX764-MAX766. The input voltage source impedance determines the size of the capacitor required at the V+ input. As with the output filter capacitor, a low-ESR capacitor is highly recommended. For output currents up to 250mA, a 100 $\mu$ F to 120 $\mu$ F capacitor with a voltage rating of at least 20V (C1) in parallel with a 0.1 $\mu$ F capacitor (C2) is adequate in most applications. **C2 must be placed as close as possible to the V+ and GND pins.**

## -5V/-12V/-15V or Adjustable, High-Efficiency, Low IQ DC-DC Inverters

### Reference Capacitor

Bypass REF with a 0.1 $\mu$ F capacitor (C3). The REF output can source up to 100 $\mu$ A for external loads.

### Layout Considerations

Proper PC board layout is essential to reduce noise generated by high current levels and fast switching waveforms. Minimize ground noise by connecting GND, the input bypass capacitor ground lead, and the

output filter capacitor ground lead to a single point (star ground configuration). Also minimize lead lengths to reduce stray capacitance, trace resistance, and radiated noise. In particular, keep the traces connected to FB and LX short. **C2 must be placed as close as possible to the V+ and GND pins.** If an external resistor divider is used (Figure 3), the trace from FB to the resistors must be extremely short.

MAX764/MAX765/MAX766

**Table 1. Component Suppliers**

PRODUCTION METHOD	INDUCTORS	CAPACITORS	DIODES
Surface Mount	Sumida CD75/105 series  Coiltronics CTX series  Coilcraft DT/D03316 series	Matsuo 267 series  Sprague 595D/293D series  AVX TPS series	Nihon EC10QS02L (Schottky)  EC11FS1 (high-speed silicon)
Miniature Through-Hole	Sumida RCH895 series	Sanyo OS-CON series (very low ESR)	Motorola 1N5817, 1N5818, (Schottky) MUR105 (high-speed silicon)
Low-Cost Through-Hole	Renco RL1284 series	Nichicon PL series	

SUPPLIER	PHONE	FAX
AVX	USA: (803) 448-9411	(803) 448-1943
Coilcraft	USA: (708) 639-6400	(708) 639-1469
Coiltronics	USA: (407) 241-7876	(407) 241-9339
Matsuo	USA: (714) 969-2491 Japan: 81-6-337-6450	(714) 960-6492 81-6-337-6456
Motorola	USA: (800) 521-6274	(602) 952-4190
Nichicon	USA: (708) 843-7500 Japan: 81-7-5231-8461	(708) 843-2798 81-7-5256-4158
Nihon	USA: (805) 867-2555 Japan: 81-3-3494-7411	(805) 867-2556 81-3-3494-7414
Renco	USA: (516) 586-5566	(516) 586-5562
Sanyo OS-CON	USA: (619) 661-6835 Japan: 81-7-2070-1005	(619) 661-1055 81-7-2070-1174
Sprague Electric Co.	USA: (603) 224-1961	(603) 224-1430
Sumida	USA: (708) 956-0666 Japan: 81-3-3607-5111	(708) 956-0702 81-3-3607-5144

# -5V/-12V/-15V or Adjustable, High-Efficiency, Low IQ DC-DC Inverters

## \_Ordering Information (continued)

PART	TEMP. RANGE	PIN-PACKAGE
MAX766CPA	0°C to +70°C	8 Plastic DIP
MAX766CSA	0°C to +70°C	8 SO
MAX766C/D	0°C to +70°C	Dice*
MAX766EPA	-40°C to +85°C	8 Plastic DIP
MAX766ESA	-40°C to +85°C	8 SO
MAX766MJA	-55°C to +125°C	8 CERDIP**

\* Dice are tested at  $T_A = +25^\circ\text{C}$ , DC parameters only.  
 \*\*Contact factory for availability and processing to MIL-STD-883.

## Chip Topography

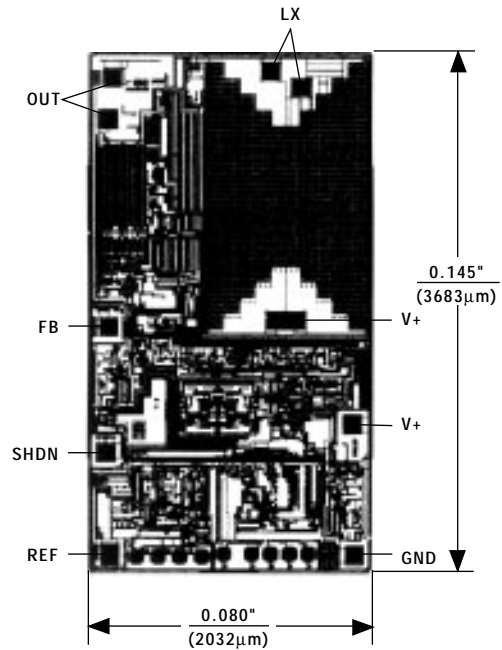

TRANSISTOR COUNT: 443  
 SUBSTRATE CONNECTED TO V+

Maxim cannot assume responsibility for use of any circuitry other than circuitry entirely embodied in a Maxim product. No circuit patent licenses are implied. Maxim reserves the right to change the circuitry and specifications without notice at any time.

12 \_\_\_\_\_ Maxim Integrated Products, 120 San Gabriel Drive, Sunnyvale, CA 94086 (408) 737-7600

© 1994 Maxim Integrated Products Printed USA **MAXIM** is a registered trademark of Maxim Integrated Products.