

Aluminum Housed Resistor, LED Load Resistor

TYPE A: RH Series
TYPE B: NH Series

Power Rating: 5W-500W
Resistance Value: 0.01Ω-100KΩ
Resistance Tolerance:
±0.1%, ±0.5%, ±1%, ±5%, ±10%

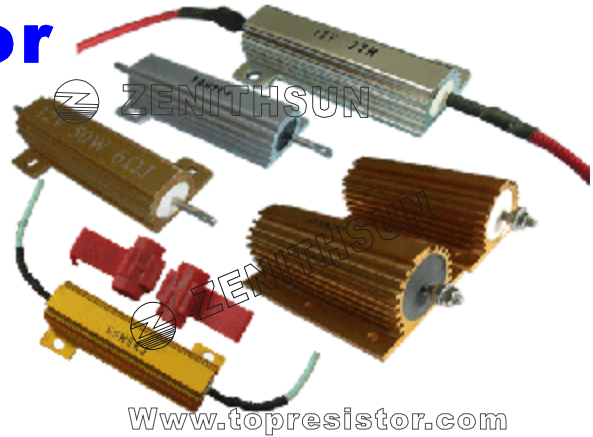

RH&NH Aluminum Resistor is also called metal aluminum resistor, non-induction aluminum resistor, golden aluminum resistor, LED aluminum Resistor, etc. according to different applications and customs. Aluminum alloy shell with grooves on the surface for better dissipation. Owing small size, high power rating, resistance to high temperature and high over load, high precision, high stability, strong construction, favorable mechanical protection, easy installation, etc.

RH&NH aluminum resistor is also the best alternative for current sense resistor, standard low-induction resistor and ultra precision resistor.

ZENITHSUN also can provide welding high temperature wires or clips to the resistors for customers when RH&NH aluminum resistor is used in Automobile LED lights industry.

● Material:

1. Encapsulant: S: Silicone, C: Cement; End caps: Stainless steel.
2. Core: Ceramic steatite or alumina.
3. Housing: Aluminum with hard anodic coating.
4. Element: Copper-nickel alloy, nickel-chrome alloy or manganese copper.

● Features:

1. High power rating, small size and ultra precision; High stability, strong construction.
2. The colours (golden yellow, red, silver) are available.
3. Standard Terminals: 5~200W Tinned terminals, 100~500W Threaded terminals; The ends connected with wires or terminal blades follow customer requirement.
4. Standard winding & non-inductive winding available. When required add "N" to the part number.
5. For non-standard technical requirements and custom special applications, please contact us to discuss the details.
6. Delivery: 5-7 days.
7. Conforms to the ROHS standard and the LEAD-FREE non-lead standard.

● Applications:

Widely used in Inverters, Automation equipment, Acoustics, Prescaler, Aging Power testing, Auto accessories, Auto LED industry.

● Standard Electrical Specifications

Model	Model	Rated power(w)		Resistance range			
		Civil	Military	±0.1%	±0.25%	±0.5%	±1%,±5%,±10%
RH005	RH-5	7.5(5)	5	1.0-510R	R50-1K2	R10-1K2	R10-10K
RH005	NH-5	7.5(5)	5	1.0-100R	1R0-200R	1R0-860R	1R0-10K
RH010	RH-10	12.5(10)	10	1.0-1K2	R50-2K7	R10-2K7	R10-56K
RH010	NH-10	12.5(10)	10	1.0-860R	1R0-1K2	1R0-1K2	1R0-56K
RH025	RH-25	25	20	R5-2K7	R10-3K9	R10-3K9	10R-100K
RH025	NH-25	25	20	1.0-1K2	1R0-2K7	1R0-2K7	1R0-100K
RH050	RH-50	50	30	R5-3K9	R10-5K6	R10-5K6	10R-100K
RH050	NH-50	50	30	1.0-2K7	1R0-3K9	1R0-3K9	1R0-100K
RH100	RH-100	100	75	R1-5K6	R10-8K2	R5-12K	R5-10K
RH100	NH-100	100	75	1.0-3K9	1R0-5K6	1R0-5K6	1R0-5K
RH150	RH-150	150	90	R1-5K6	1R0-8K2	R10-12K	1R0-12K
RH150	NH-150	150	90	1R0-3K9	1R0-5K6	1R0-6K	1R0-6K
RH200	RH-200	200	100	R10-8K2	1R0-10K	R10-12K	1R0-12K
RH200	NH-200	200	100	1R0-5K6	1R0-8K2	1R0-6K	1R0-6K
RH250	RH-250	250	120	R1-12K	R10-10K	R10-10K	R10-10K
RH250	NH-250	250	120	1R0-5K6	1R0-8K2	1R0-12K	1R0-12K
RH300	RH-300	300	145	R1-12K	R10-10K	R10-10K	R10-10K
RH300	NH-300	300	145	1R0-5K6	1R0-8K2	1R0-12K	1R0-12K
RH500	RH-250	500	250	R1-12K	R10-15K	R10-15K	R10-15K
RH500	NH-250	500	250	1R0-5K6	1R0-7K5	1R0-7K5	1R0-7K5

● Dimensions RH / NH :5W 10W 25W 50W

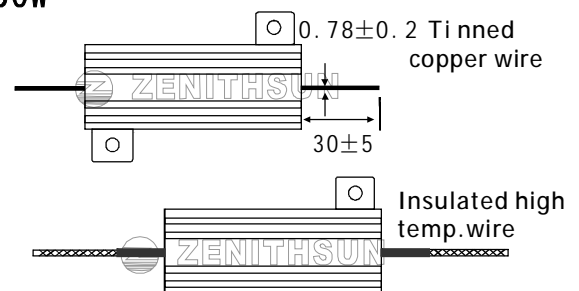
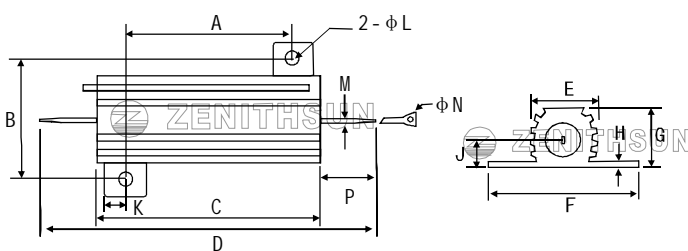

POWER RATING	A ±0.2	B ±0.2	C ±0.5	D ±2	E ±0.5	F ±0.5	G ±0.4	H ±0.2	J ±0.5	K ±0.2	L ±0.2	M ±0.1	N ±0.2	P ±1.5	Weight ±1.5g
5W	11.2	12.5	15.2	28.6	8.5	16.4	8.1	1.7	3.8	2.0	2.2	1.2	1.3	7.0	6g
10W	14.2	15.9	19.5	35.0	10.7	20.3	9.9	1.9	4.2	2.4	2.2	2.0	2.2	8.0	11g
25W	18.2	19.8	27.5	49.0	14.0	27.4	13.9	2.2	6.1	5.0	3.2	2.0	2.2	11.0	18g
	18.2	19.8	27.5	49.0	15.5	27.5	15.5	2.2	6.6	5.0	3.2	2.0	2.2	11.0	20g
50W	40.0	21.5	50.1	72.0	15.5	27.5	15.5	2.2	6.6	5.0	3.2	2.0	2.2	11.0	30g

We can do the resistors following customer special requirement.

● Dimensions

RH / NH :75W 100W 150W 200W

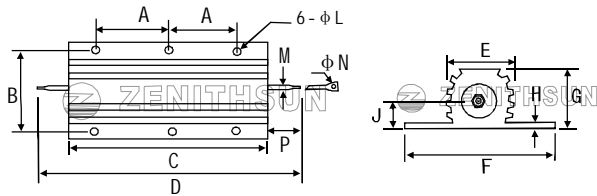

RH / NH :250W 300W 500W

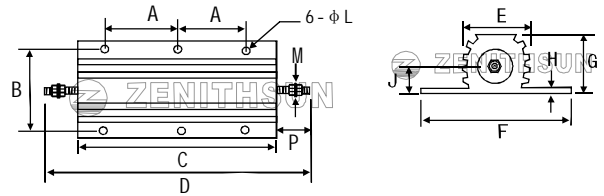

POWER RATING	A	B	C	D	E	F	G	H	J	K	L	M	N	P	Weight
	±0.2	±0.2	±0.5	±2	±0.5	±0.5	±0.4	±0.2	±0.5	±0.2	±0.2	±0.1	±0.2	±2	±5g
75W	23.5	38	65.5	105	27	48	26	3.3	11.5	/	4.2	2.8	2.2	20	90g
100W	36.5	38	98	138	27	48	26	3.3	11.5	/	4.2	2.8	2.2	20	160g
150W	52.0	38	135	175	27	48	26	3.3	11.5	/	4.2	2.8	2.2	20	240g
200W	70.0	38	165	205	27	48	26	3.3	11.5	/	4.2	2.8	2.2	20	420g
250W	45.5	58	112	152	46.5	73	45	5.5	21	/	21	6	/	20	480g
300W	51.5	58	130	170	46.5	73	45	5.5	21	/	21	6	/	20	580g
500W	87.0	58	204	244	46.5	73	45	5.5	21	/	21	6	/	20	970g

We can do the resistors following customer special requirement.

RH / NH :100W(non standard size)

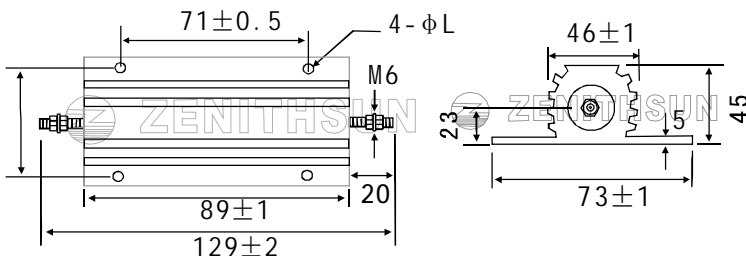

RH / NH :250W(non standard size)

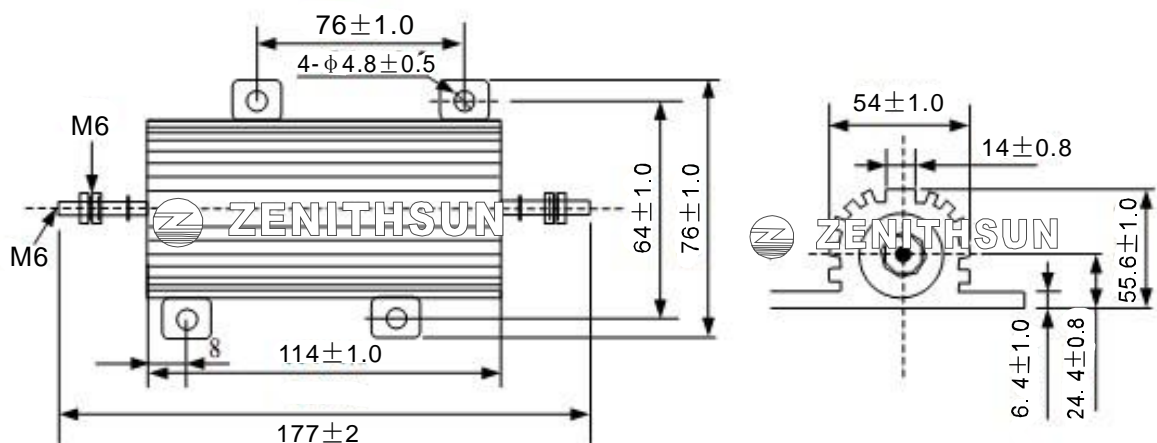

● Technical Specifications

Parameter	Unit	Resistors characteristics
Temperature coefficients	PPM/°C	±20Ppm/°C ; ±50Ppm/°C ; ±100Ppm/°C ; ±200Ppm/°C ; ±250Ppm/°C
Short time overload	VAC	1000V for 5w,10w,25w ; 2000v for 50w ; 2500V for 75w-500w
Short time overload)	/	5×rated power for 5 seconds
Maximum working voltage	V	$\sqrt{P \times R}$
Insulation resistance	Ω	10000Megohm minimum dry,1000Megohm minimum after moisture test
Terminal tensile strength	N	22.2N for 5w-25w ,44.4N for all other
Solderability	/	MIL-PRF-18546 Type - Meets requirements of ANSI.J -STD-002
Temperature range	°C	-55/+250

● Performance Specifications

Test	Concitions of test	Test limits
Thermal shock	Rated power applied until thermally stable,then a minimum of 15 min at -55 °C	$\Delta R \leq \pm (0.5\%R + 0.05R)$
Short time overload	5* rated power for 5S	$\Delta R \leq \pm (0.5\%R + 0.05R)$
Insulation voltage	5W-25W 1000V 50W 2000V 75W-500W 4500V AC ; 1min	$\Delta R \leq \pm (0.2\%R + 0.05R)$
Temperature	250°C, 2h	$\Delta R \leq \pm (0.5\%R + 0.05R)$
Moisture resistance	MIL-STD-202 Method 106,7b not applicable	$\Delta R \leq \pm (1.0\%R + 0.05R)$
Shock specified pulse	MIL-STD-202 Method 213,100g,6ms,10shocks	$\Delta R \leq \pm (0.2\%R + 0.05R)$
Vibration high frequency	Frequency varied 10-2000HZ,20g peak,2directions,6h	$\Delta R \leq \pm (0.2\%R + 0.05R)$
Load life	Rated power,1000h,25°C ,1.5h ON,0.5h OFF	$\Delta R \leq \pm (5.0\%R + 0.05R)$
Terminal strength	5 Pound pull test:5-10W 30s,10 pound pull test for other size. Torque test:24 pound inch for 75W-200W,32 pound inch for 250W-500W	$\Delta R \leq \pm (0.2\%R + 0.05R)$

● Power Rating

Resistors wattage ratings are based on mounting to the following heat sink(unit:mm)

5W-10W: 102*152*1mm
 25W: 127*178*1mm
 50W: 305*305*1.5mm
 75W-500W: 305*305*3.2mm

● Ambient Temperature Derating

Derating is required for ambient temperatures above 25,see the following graph:

Curves A.B.C apply to operation of unmounted resistors. Curves D applies to all types when mounted to specified heat sink.

A:5W and 10W , unmounted

B:25W,unmounted

C:50W and 75W,100W,150W,200W,250W,300W,500W ,unmounted

D:All types mounted to recommended aluminum heat sink

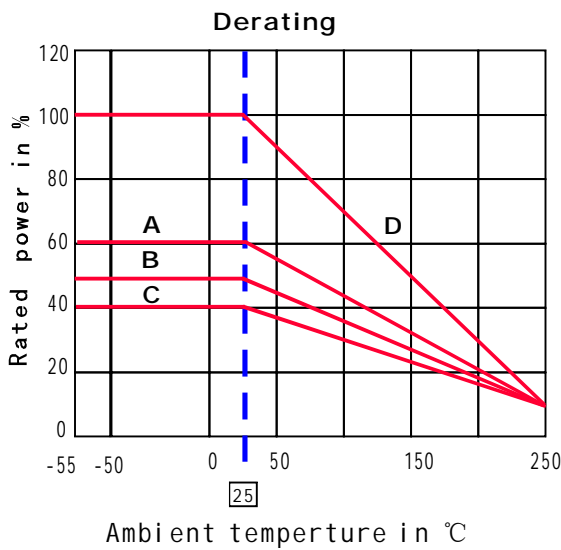

● Reduced Heat Sink Derating

Derating is also required when recommended heat sink area is reduced
 A: 5W and 10w
 B: 25W
 C: 50W-500W

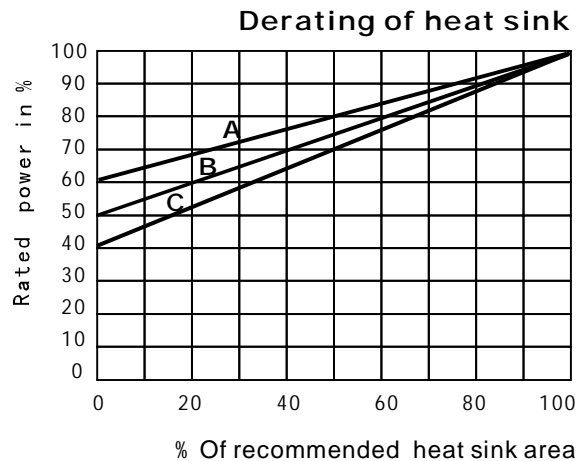

● Material Specifications

Element: Copper-nickel alloy or nickel-chrome alloy, depending on resistance value
Core: Ceramic, steatite or alumina, depending on physical size
Housing: Aluminum with hard anodic coating
Standard Terminals: Tinned Copperweld on 5W through 200W size. Threaded stainless steel terminals on 100W, 250W, 300W, 500W.
Part Marking: VTM, Model, Wattage, Value, Tolerance, Date Code.

● NH Non-inductive

Models of equivalent physical and electrical specifications are available with non-inductive (Aryton-Perry) winding. They are identified by substituting the letter N for R in the mode number (NH50, for example).

● Special Modifications

A number of special modifications to the aluminum housed resistor style are available upon request. Special modifications include:

1. Terminal configurations and materials
2. Resistance values and tolerances
3. Low resistance temperature coefficient (RTC)
4. Housing configuration
5. Threaded mounting hole
6. The ends connected with wires or terminal blades
7. Preconditioning and other additional testing

● Applicable MIL Specifications

MIL-PRF-18546 is the military specification covering aluminum housed, chassis mount, power resistors.

● How To Order

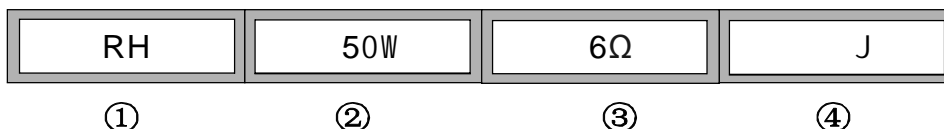

- ① Type: RH and NH
- ② Rated Power (W): 5W-500W
- ③ Resistance Value (Ω): 0.01Ω - 100KΩ
- ④ Tolerance (%): ±0.1%, ±1%, ±2%, ±5%, ±10%