

### GENERAL DESCRIPTION

The SGM2202 series is a set of low power high voltage regulators implemented in CMOS technology which can provide 150mA output current. The device allows input voltage as high as 36V. The SGM2202 series is available in adjustable and several fixed output voltages. CMOS technology ensures low dropout voltage and low quiescent current.

Although designed primarily as fixed voltage regulators, the device can be used with external components to obtain variable output voltages.

The SGM2202 series is available in Green SOT-23-5 and SOT-23-6 packages. It operates over an ambient temperature range of -40°C to +85°C.

### FEATURES

- Low Power Consumption
- 150mA Nominal Output Current
- Low Dropout Voltage
- High PSRR
- Low Temperature Coefficient
- High Input Voltage (Up to 36V)
- Output Voltage Accuracy:  $\pm 2.5\%$
- Fixed Output Voltage Versions:
  - 0.8V to 4.7V with 0.1V per Step
  - 5V to 12V with 0.25V per Step
- Adjustable Output Voltages: 0.8V to 13.2V
- -40°C to +85°C Operating Temperature Range
- Available in Green SOT-23-5 and SOT-23-6 Packages

### APPLICATIONS

Battery-Powered Equipment  
 Communication Equipment  
 Audio/Video Equipment

### TYPICAL APPLICATION

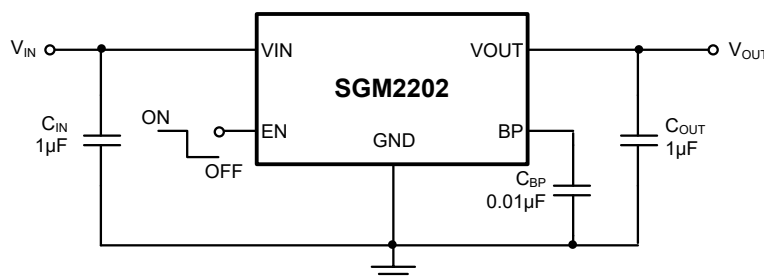

Figure 1. Fixed Voltage Typical Application Circuit

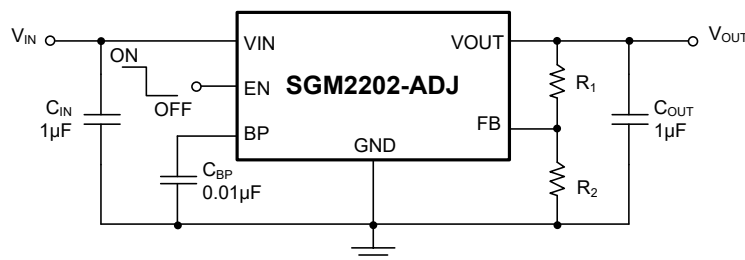

Figure 2. Adjustable Voltage Typical Application Circuit

## PACKAGE/ORDERING INFORMATION

MODEL	V <sub>OUT</sub> (V)	PACKAGE DESCRIPTION	SPECIFIED TEMPERATURE RANGE	ORDERING NUMBER	PACKAGE MARKING	PACKING OPTION
SGM2202-1.8	1.8	SOT-23-5	-40°C to +85°C	SGM2202-1.8YN5G/TR	G49XX	Tape and Reel, 3000
SGM2202-2.5	2.5	SOT-23-5	-40°C to +85°C	SGM2202-2.5YN5G/TR	G1DXX	Tape and Reel, 3000
SGM2202-2.8	2.8	SOT-23-5	-40°C to +85°C	SGM2202-2.8YN5G/TR	SX5XX	Tape and Reel, 3000
SGM2202-3.0	3.0	SOT-23-5	-40°C to +85°C	SGM2202-3.0YN5G/TR	SX6XX	Tape and Reel, 3000
		SOT-23-5 (L-Type)	-40°C to +85°C	SGM2202-3.0YN5LG/TR	G12XX	Tape and Reel, 3000
SGM2202-3.3	3.3	SOT-23-5	-40°C to +85°C	SGM2202-3.3YN5G/TR	SX8XX	Tape and Reel, 3000
SGM2202-3.6	3.6	SOT-23-5	-40°C to +85°C	SGM2202-3.6YN5G/TR	G4AXX	Tape and Reel, 3000
SGM2202-4.0	4.0	SOT-23-5	-40°C to +85°C	SGM2202-4.0YN5G/TR	G60XX	Tape and Reel, 3000
SGM2202-5.0	5.0	SOT-23-5	-40°C to +85°C	SGM2202-5.0YN5G/TR	G3DXX	Tape and Reel, 3000
SGM2202-ADJ	Adjustable	SOT-23-6	-40°C to +85°C	SGM2202-ADJYN6G/TR	SVFXX	Tape and Reel, 3000

NOTE: The devices are available in fixed output voltages from 0.8V to 4.7V with 0.1V per step, and from 5V to 12V with 0.25V per step.

## MARKING INFORMATION

NOTE: XX = Date Code.

YYY X X

Date Code - Month
   
Date Code - Year
   
Serial Number

Green (RoHS & HSF): SG Micro Corp defines "Green" to mean Pb-Free (RoHS compatible) and free of halogen substances. If you have additional comments or questions, please contact your SGMICRO representative directly.

**ABSOLUTE MAXIMUM RATINGS**

VIN, EN to GND .....	-0.3V to 44V
VOUT to GND .....	-0.3V to Min(VIN + 0.3V, 15V)
BP, FB to GND .....	-0.3V to Min(VIN + 0.3V, 6V)
Power Dissipation, PD @ TA = +25°C	
SOT-23-5, SOT-23-5 (L-Type) .....	0.517W
SOT-23-6 .....	0.558W
Package Thermal Resistance	
SOT-23-5, SOT-23-5 (L-Type), θJA .....	242°C/W
SOT-23-6, θJA .....	224°C/W
Junction Temperature .....	+150°C
Storage Temperature Range .....	-65°C to +150°C
Lead Temperature (Soldering, 10s) .....	+260°C
ESD Susceptibility	
HBM .....	4000V
MM .....	150V
CDM .....	1000V

**RECOMMENDED OPERATING CONDITIONS**

Input Voltage Range .....	2.7V to 36V
Operating Temperature Range .....	-40°C to +85°C

**OVERSTRESS CAUTION**

Stresses beyond those listed in Absolute Maximum Ratings may cause permanent damage to the device. Exposure to absolute maximum rating conditions for extended periods may affect reliability. Functional operation of the device at any conditions beyond those indicated in the Recommended Operating Conditions section is not implied.

**ESD SENSITIVITY CAUTION**

This integrated circuit can be damaged by ESD if you don't pay attention to ESD protection. SGMICRO recommends that all integrated circuits be handled with appropriate precautions. Failure to observe proper handling and installation procedures can cause damage. ESD damage can range from subtle performance degradation to complete device failure. Precision integrated circuits may be more susceptible to damage because very small parametric changes could cause the device not to meet its published specifications.

**DISCLAIMER**

SG Micro Corp reserves the right to make any change in circuit design, or specifications without prior notice.

PIN CONFIGURATIONS

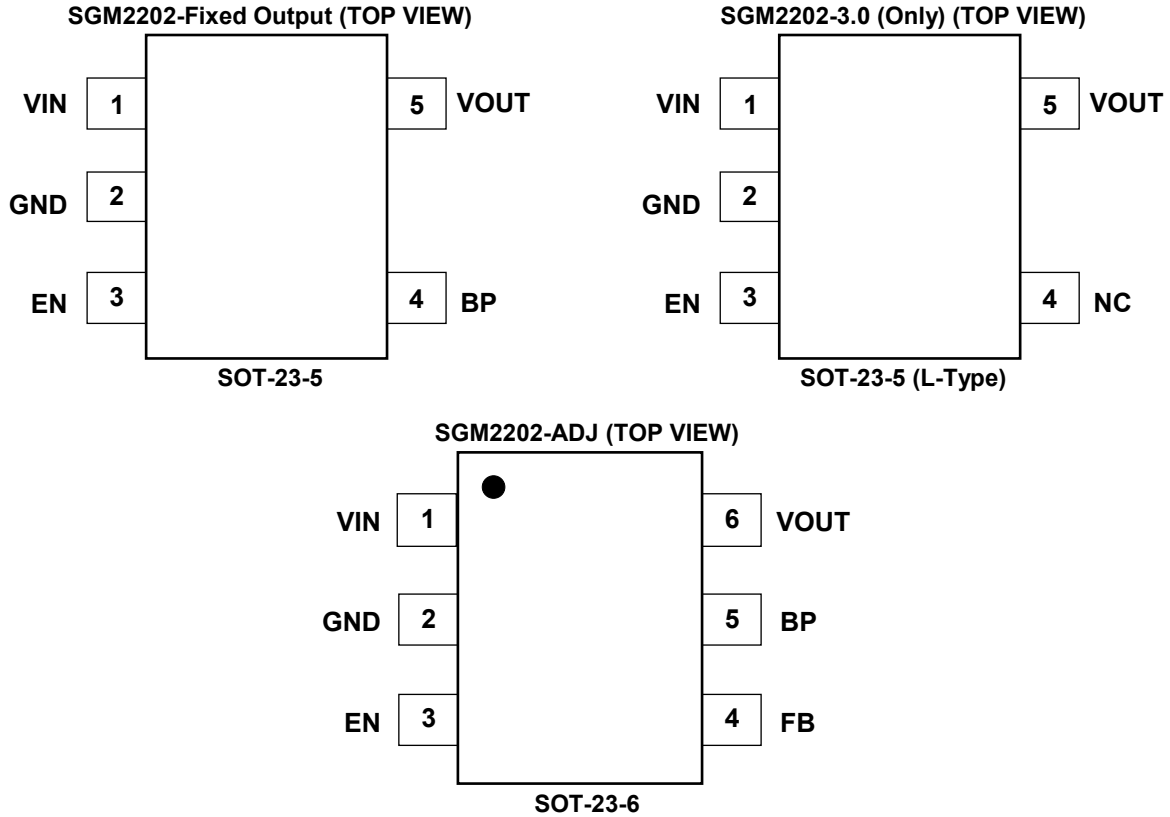

PIN DESCRIPTION

PIN			NAME	FUNCTION
SOT-23-5	SOT-23-5 (L-Type)	SOT-23-6		
1	1	1	VIN	Regulator Input. Up to 36V input voltage. At least 1µF supply bypass capacitor is recommended.
2	2	2	GND	Ground.
3	3	3	EN	Shutdown Input. Connect to VIN pin for normal operation.
-	-	4	FB	Feedback Pin (adjustable voltage version only). This is used to set the output voltage of the device.
4	-	5	BP	Reference-Noise Bypass Pin. Bypass with a low-leakage 0.01µF ceramic capacitor for reduced noise at the output.
-	4	-	NC	Not Connected.
5	5	6	VOUT	Regulator Output. Recommended output capacitor range: 1µF to 10µF.

## ELECTRICAL CHARACTERISTICS

( $V_{IN} = 15V$ ,  $V_{EN} = 2V$ ,  $C_{IN} = C_{OUT} = 1\mu F$ ,  $C_{BP} = 0.01\mu F$ , Full =  $-40^{\circ}C$  to  $+85^{\circ}C$ , typical values are at  $T_A = +25^{\circ}C$ , unless otherwise noted.)

PARAMETER	SYMBOL	CONDITIONS	TEMP	MIN	TYP	MAX	UNITS
Input Voltage	$V_{IN}$	$V_{OUT} < 3.3V$	Full	2.7		32	V
		$V_{OUT} \geq 3.3V$	Full	2.7		36	
Output Voltage Accuracy		$I_{OUT} = 1mA$	$+25^{\circ}C$	-2.5		2.5	%
Feedback Voltage	$V_{FB}$	SGM2202-ADJ, $V_{FB} = V_{OUT}$ , $I_{OUT} = 1mA$	$+25^{\circ}C$		0.8		V
FB Input Current	$I_{FB}$	SGM2202-ADJ, $V_{FB} = 0.9V$	Full	-15		15	nA
Ground Pin Current		No Load	$+25^{\circ}C$		4.2	5.4	$\mu A$
			Full			6.5	
		$I_{OUT} = 50mA$	$+25^{\circ}C$		4.2		
Maximum Output Current <sup>(1)</sup>		$V_{IN} = V_{OUT} + 2V$ or $4V$ , whichever is greater	$+25^{\circ}C$	150			mA
Dropout Voltage <sup>(2)</sup>	$V_{DROP}$	$I_{OUT} = 150mA$ , $V_{OUT} \geq 2.5V$	$+25^{\circ}C$		1300	1840	mV
			Full			2380	
Line Regulation	$\frac{\Delta V_{OUT}}{\Delta V_{IN} \times V_{OUT}}$	$V_{IN} = V_{OUT} + 2V$ or $4V$ to $32V$ , $I_{OUT} = 1mA$ , $V_{OUT} < 3.3V$	$+25^{\circ}C$		0.005	0.01	%V
		$V_{IN} = V_{OUT} + 2V$ to $36V$ , $I_{OUT} = 1mA$ , $V_{OUT} \geq 3.3V$	$+25^{\circ}C$		0.005	0.01	
Load Regulation	$\Delta V_{OUT}$	$V_{IN} = V_{OUT} + 2V$ or $4V$ , $I_{OUT} = 1mA$ to $150mA$	$+25^{\circ}C$		10	24	mV
Power Supply Rejection Ratio	PSRR	$V_{OUT} = 3.3V$ , $I_{OUT} = 10mA$	$f = 217Hz$	$+25^{\circ}C$		55	dB
			$f = 1kHz$	$+25^{\circ}C$		40	
Output Voltage Temperature Coefficient <sup>(3)</sup>	$\frac{\Delta V_{OUT}}{\Delta T_A \times V_{OUT}}$	$V_{IN} = V_{OUT} + 2V$ or $4V$ , $I_{OUT} = 1mA$	Full		35		ppm/ $^{\circ}C$
<b>Shutdown</b>							
EN Input Threshold	$V_{IH}$	$V_{IN} = 2.7V$ to $36V$	Full	1.2			V
	$V_{IL}$		Full			0.4	
EN Input Bias Current	$I_{BH}$	$V_{EN} = V_{IN}$	Full		0.02	1	$\mu A$
	$I_{BL}$	$V_{EN} = 0V$	Full	-1		1	
Shutdown Supply Current	$I_{Q(SHDN)}$	$V_{EN} = 0V$	$+25^{\circ}C$		1.5	2	$\mu A$
Start-Up Time <sup>(4)</sup>	$t_{STR}$	No load	$+25^{\circ}C$		5		ms
$R_{ON}$ of Discharge MOSFET		$V_{IN} = 2.7V$ , $V_{EN} = 0V$ , $I_{OUT} = -1mA$	$+25^{\circ}C$		75		$\Omega$
<b>Thermal Protection</b>							
Thermal Shutdown Temperature	$T_{SHDN}$				150		$^{\circ}C$
Thermal Shutdown Hysteresis	$\Delta T_{SHDN}$				20		$^{\circ}C$

## NOTES:

- Maximum output current is affected by the PCB layout, size of metal trace, the thermal conduction path between metal layers, ambient temperature and the other environment factors of system. Attention should be paid to the dropout voltage when  $V_{IN} < V_{OUT} + V_{DROP}$ .
- The dropout voltage is defined as  $V_{IN} - V_{OUT}$ , when  $V_{OUT}$  is 95% of the value of  $V_{OUT}$  for  $V_{IN} = V_{OUT} + 2V$ .
- Output voltage temperature coefficient is defined as the worst-case voltage change divided by the total temperature range.
- Time needed for  $V_{OUT}$  to reach 90% of final value.

**TYPICAL PERFORMANCE CHARACTERISTICS**

$V_{IN} = 5.3V$ ,  $V_{EN} = 2V$ ,  $V_{OUT} = 3.3V$ ,  $C_{IN} = C_{OUT} = 1\mu F$ ,  $C_{BP} = 0.01\mu F$ ,  $T_A = +25^\circ C$ , unless otherwise noted.

Load-Transient Response

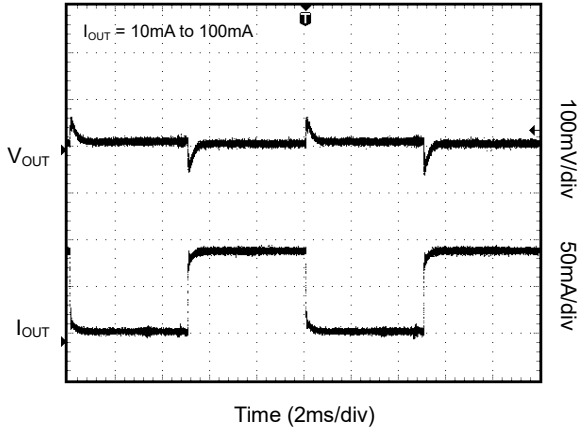

Line-Transient Response

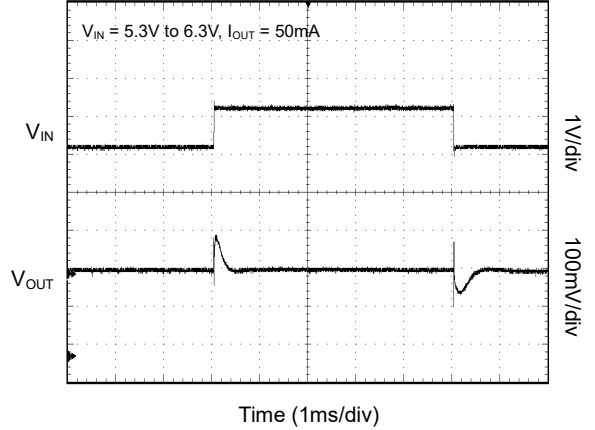

Power-Up/Power-Down Output Waveform

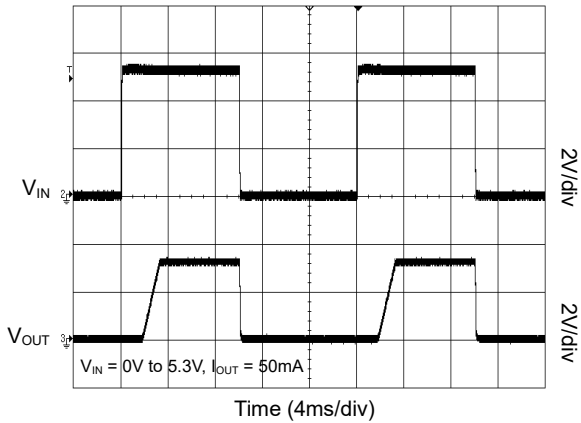

Power Ramp-Up/Ramp-Down Output Waveform

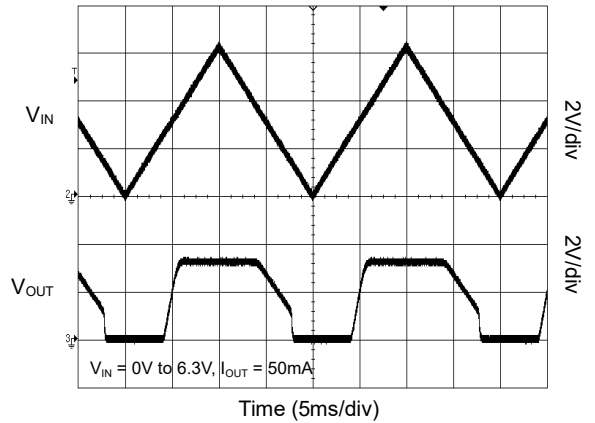

Output Short Waveform

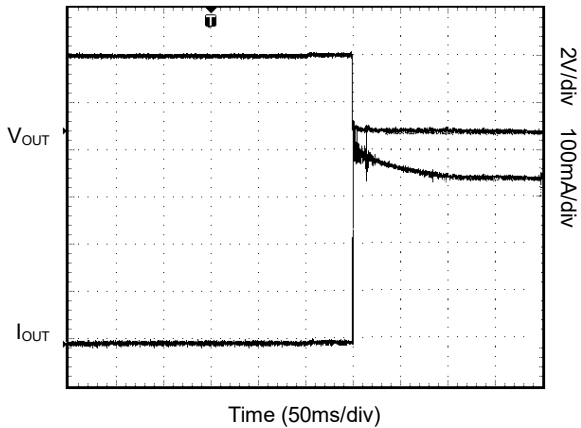

Thermal Protection Waveform

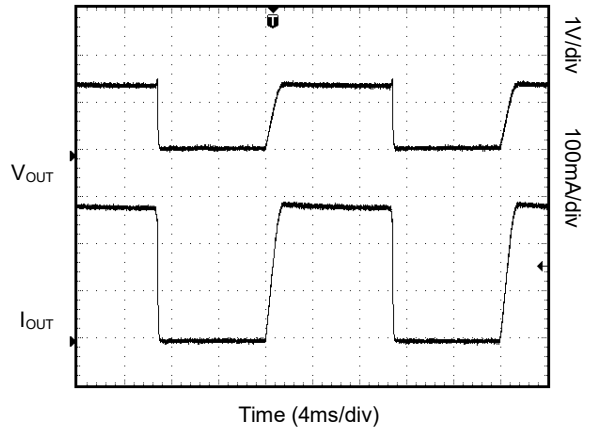

**TYPICAL PERFORMANCE CHARACTERISTICS (continued)**

$V_{IN} = 5.3V$ ,  $V_{EN} = 2V$ ,  $V_{OUT} = 3.3V$ ,  $C_{IN} = C_{OUT} = 1\mu F$ ,  $C_{BP} = 0.01\mu F$ ,  $T_A = +25^\circ C$ , unless otherwise noted.

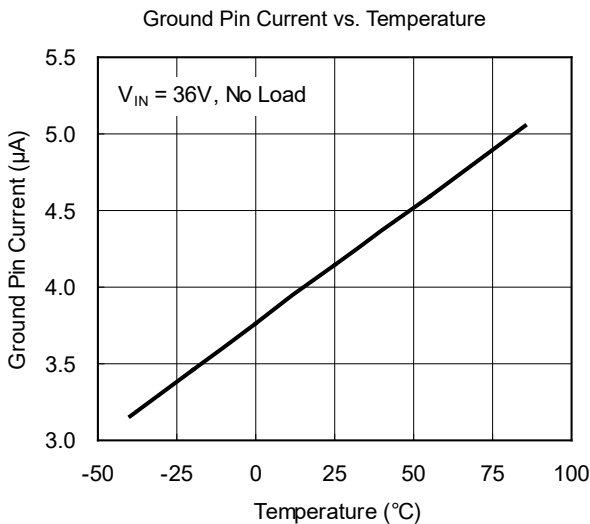
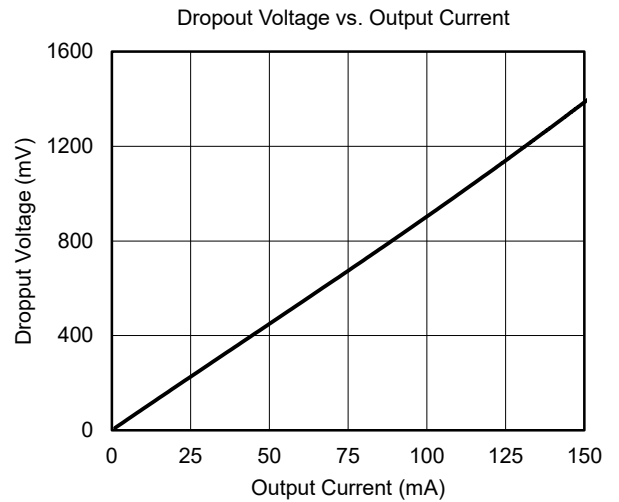
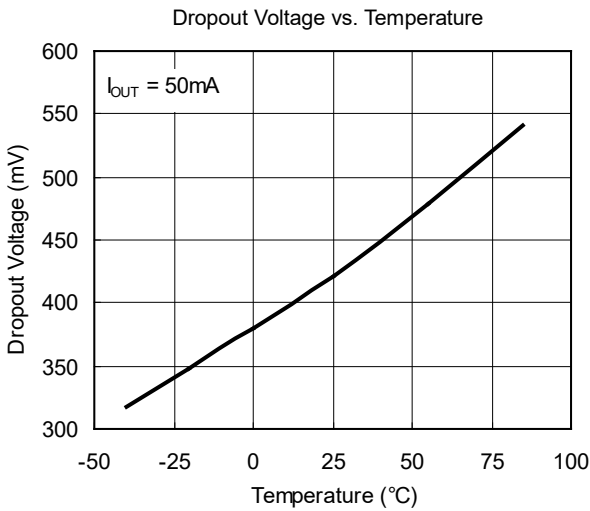
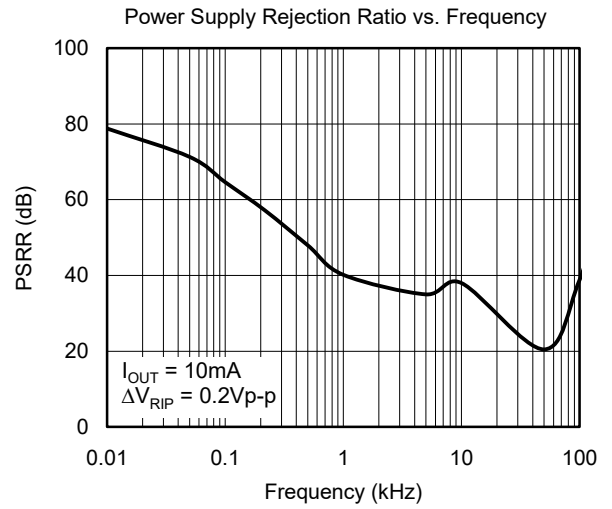
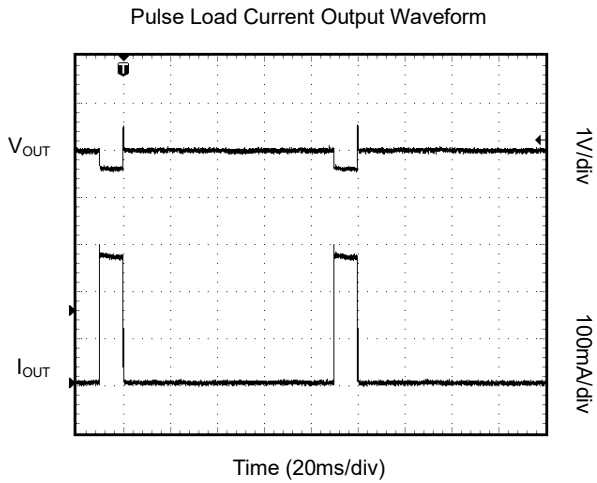

**DETAILED DESCRIPTION**

The SGM2202 series is a linear regulator designed primarily for high input voltage applications. The SGM2202 series is available in several fixed output voltages and adjustable from 0.8V to 13.2V with a simple resistor divider. The maximum output current is dependent on the package’s maximum power dissipation for a given temperature.

CMOS technology ensures low dropout voltage and low quiescent current.

The SGM2202 adjustable voltage version uses external feedback, allowing the user to set the output voltage with an external resistor divider. The typical FB pin voltage is 0.8V.

The IC enters shutdown mode when EN is low. In shutdown mode, the pass transistor and control circuitry are turned off, reducing the supply current to < 2µA. Connect EN to VIN for automatic startup.

**APPLICATION INFORMATION**

**Setting the Output Voltage**

Set the output voltage of the SGM2202 adjustable voltage version by using a resistor divider as shown:

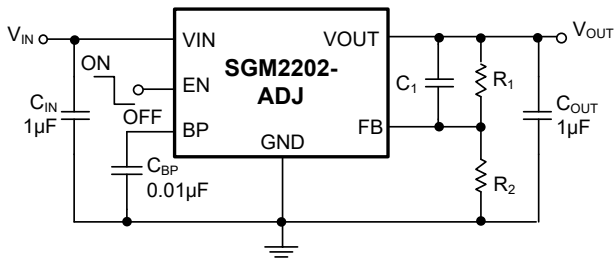

Figure 3. SGM2202-ADJ with External Resistor Divider

Choose R<sub>2</sub> = 2MΩ to maintain a 0.4µA minimum load. Calculate the value for R<sub>1</sub> using the following equation:

$$R_1 = R_2 \times \left( \frac{V_{OUT}}{0.8V} - 1 \right)$$

**Input Capacitor and Output Capacitor**

For proper operation, place a ceramic capacitor (C<sub>IN</sub>) between 1µF and 10µF between the input pin and ground. Larger values in this range will help improve line transient response.

For stable operation, use a ceramic capacitor (C<sub>OUT</sub>) between 1µF and 10µF. Larger values in this range will help improve load transient response and reduce noise. Output capacitors of other dielectric types may be used, but are not recommended as their capacitance can deviate greatly from their rated value over temperature.

**Thermal Considerations**

When the junction temperature is too high, the thermal protection circuitry sends a signal to the control logic that will shutdown the IC. The IC will restart when the temperature has sufficiently cooled down.

The maximum power dissipation is dependent on the thermal resistance of the case and the circuit board, the temperature difference between the die junction and the ambient air, and the rate of air flow.

**REVISION HISTORY**

NOTE: Page numbers for previous revisions may differ from page numbers in the current version.

Changes from Original (APRIL 2017) to REV.A	Page
Changed from product preview to production data.....	All



PACKAGE OUTLINE DIMENSIONS

SOT-23-5

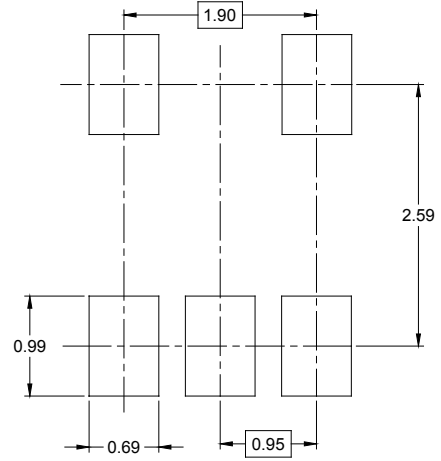
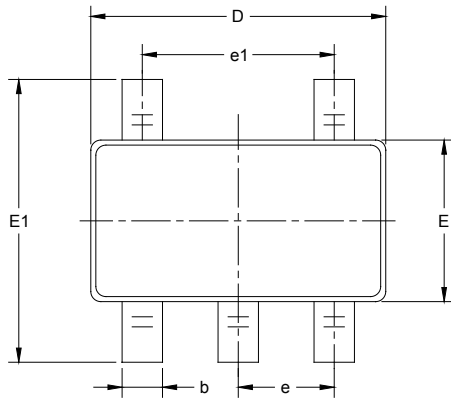

RECOMMENDED LAND PATTERN (Unit: mm)

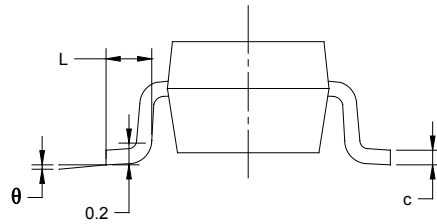

Symbol	Dimensions In Millimeters		Dimensions In Inches	
	MIN	MAX	MIN	MAX
A	1.050	1.250	0.041	0.049
A1	0.000	0.100	0.000	0.004
A2	1.050	1.150	0.041	0.045
b	0.300	0.500	0.012	0.020
c	0.100	0.200	0.004	0.008
D	2.820	3.020	0.111	0.119
E	1.500	1.700	0.059	0.067
E1	2.650	2.950	0.104	0.116
e	0.950 BSC		0.037 BSC	
e1	1.900 BSC		0.075 BSC	
L	0.300	0.600	0.012	0.024
$\theta$	0°	8°	0°	8°

PACKAGE OUTLINE DIMENSIONS

SOT-23-6

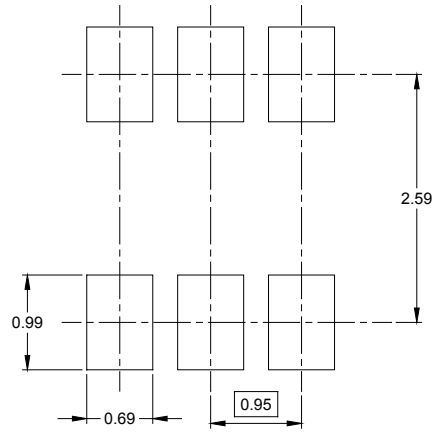
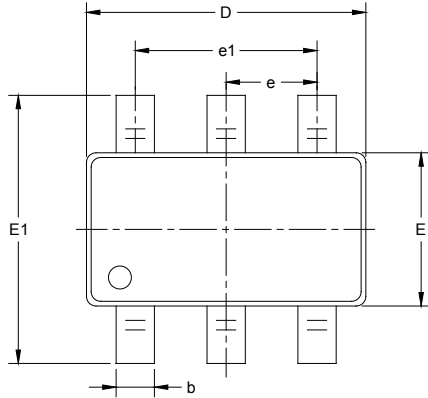

RECOMMENDED LAND PATTERN (Unit: mm)

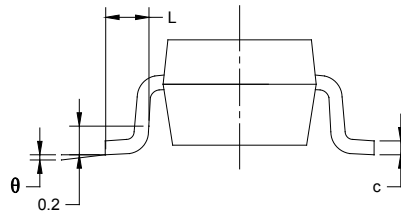
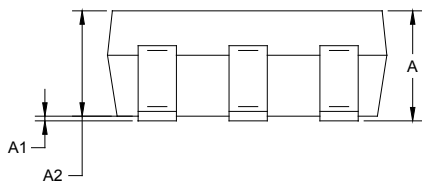

Symbol	Dimensions In Millimeters		Dimensions In Inches	
	MIN	MAX	MIN	MAX
A	1.050	1.250	0.041	0.049
A1	0.000	0.100	0.000	0.004
A2	1.050	1.150	0.041	0.045
b	0.300	0.500	0.012	0.020
c	0.100	0.200	0.004	0.008
D	2.820	3.020	0.111	0.119
E	1.500	1.700	0.059	0.067
E1	2.650	2.950	0.104	0.116
e	0.950 BSC		0.037 BSC	
e1	1.900 BSC		0.075 BSC	
L	0.300	0.600	0.012	0.024
$\theta$	0°	8°	0°	8°

# PACKAGE INFORMATION

## TAPE AND REEL INFORMATION

### REEL DIMENSIONS



### TAPE DIMENSIONS



NOTE: The picture is only for reference. Please make the object as the standard.

### KEY PARAMETER LIST OF TAPE AND REEL

Package Type	Reel Diameter	Reel Width W1 (mm)	A0 (mm)	B0 (mm)	K0 (mm)	P0 (mm)	P1 (mm)	P2 (mm)	W (mm)	Pin1 Quadrant
SOT-23-5	7"	9.5	3.20	3.20	1.40	4.0	4.0	2.0	8.0	Q3
SOT-23-6	7"	9.5	3.17	3.23	1.37	4.0	4.0	2.0	8.0	Q3

DD0001

# PACKAGE INFORMATION

## CARTON BOX DIMENSIONS



NOTE: The picture is only for reference. Please make the object as the standard.

## KEY PARAMETER LIST OF CARTON BOX

Reel Type	Length (mm)	Width (mm)	Height (mm)	Pizza/Carton
7" (Option)	368	227	224	8
7"	442	410	224	18

DD0002