



SGM6013

1.6MHz, 800mA Synchronous Step-Down Converter

GENERAL DESCRIPTION

The SGM6013 is a 1.6MHz, constant frequency, current mode, synchronous, step-down switching regulator. It can deliver 800mA load current from 2.5V to 5.5V input voltage, and output voltage can be as low as 0.6V.

High switching frequency minimizes the sizes of inductor and capacitor. Integrated power MOSFETs and internal compensation make the SGM6013 simple to use and fit the total solution in a compact space.

The SGM6013 can also run at 100% duty cycle for low dropout operation, extending battery life in portable system. The synchronous architecture eliminates the external Schottky diode, and achieves over 90% of the power conversion efficiency. Low output ripple voltage at light load, 30 μ A quiescent current and less than 1 μ A of shutdown current make SGM6013 the ideal power supply solution for portable applications.

SGM6013 is available in both adjustable and fixed (1.2V, 1.8V, 3.3V) output voltage versions. It is in the Green TSOT-23-5 and TDFN-2 \times 2-6L packages. It is rated over the -40 $^{\circ}$ C to +85 $^{\circ}$ C temperature range.

TYPICAL APPLICATION

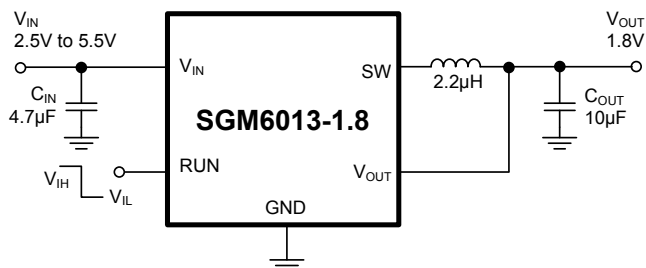

FEATURES

- **High Efficiency: Up to 95%**
- **30 μ A Low Quiescent Current at Light Load**
- **800mA Output Current**
- **Input Voltage Range: 2.5V to 5.5V**
- **1.2V, 1.8V & 3.3V Fixed & Adjustable Output Voltages**
- **0.6V Reference Voltage**
- **1.6MHz Constant Switching Frequency**
- **Less than 1 μ A Shutdown Current**
- **100% Duty Cycle for Lowest Dropout**
- **No External Power MOSFETs and Schottky Diode Required**
- **Excellent Line Regulation & Load Transient Response**
- **-40 $^{\circ}$ C to +85 $^{\circ}$ C Operating Temperature Range**
- **Available in Green TSOT-23-5 and TDFN-2 \times 2-6L Packages**

APPLICATIONS

GPS
MP3 Players
Cellular, Smart Phones
Digital Book Readers
Digital Still Cameras
Portable Instruments
Wireless and DSL Modems
Battery Powered Equipments
Microprocessor, DSP Power Supplies

PACKAGE/ORDERING INFORMATION

MODEL	V _{OUT} (V)	PIN-PACKAGE	SPECIFIED TEMPERATURE RANGE	ORDERING NUMBER	PACKAGE MARKING	PACKAGE OPTION
SGM6013	1.2V	TSOT-23-5	-40°C to +85°C	SGM6013-1.2YTN5G/TR	SC1XX	Tape and Reel, 3000
	1.8V	TSOT-23-5	-40°C to +85°C	SGM6013-1.8YTN5G/TR	SH5XX	Tape and Reel, 3000
	3.3V	TSOT-23-5	-40°C to +85°C	SGM6013-3.3YTN5G/TR	SH6XX	Tape and Reel, 3000
	Adjustable	TSOT-23-5	-40°C to +85°C	SGM6013-ADJYTN5G/TR	SC2XX	Tape and Reel, 3000
	Adjustable	TDFN-2x2-6L	-40°C to +85°C	SGM6013-ADJYTDI6G/TR	SC2 XXXX	Tape and Reel, 3000

NOTE: XX = Date Code. XXXX = Date Code.

Green (RoHS & HSF): SG Micro Corp defines "Green" to mean Pb-Free (RoHS compatible) and free of halogen substances. If you have additional comments or questions, please contact your SGMICRO representative directly.

MARKING INFORMATION

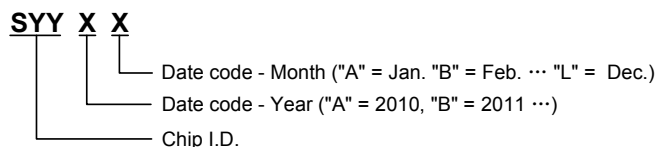

For example: SC1CD(2012, April)

ABSOLUTE MAXIMUM RATINGS

Input Supply Voltage.....	-0.3V to 6V
RUN, V _{FB} Voltages.....	-0.3V to V _{IN}
SW Voltage.....	-0.3V to (V _{IN} + 0.3V)
Package Thermal Resistance	
TSOT-23-5, θ_{JA}	200°C/W
TDFN-2x2-6L, θ_{JA}	200°C/W
P-Channel Switch Source Current (DC).....	800mA
N-Channel Switch Sink Current (DC).....	800mA
Peak SW Sink and Source Current.....	1.3A
Operating Temperature Range.....	-40°C to +85°C
Junction Temperature.....	150°C
Storage Temperature Range.....	-65°C to +150°C
Lead Temperature (Soldering, 10s).....	260°C
ESD Susceptibility	
HBM.....	4000V
MM.....	300V

NOTE:

Stresses beyond those listed under "Absolute Maximum Ratings" may cause permanent damage to the device. These are stress ratings only, and functional operation of the device at these or any other conditions beyond those indicated in the operational sections of the specifications is not implied. Exposure to absolute maximum rating conditions for extended periods may affect device reliability.

CAUTION

This integrated circuit can be damaged by ESD if you don't pay attention to ESD protection. SGMICRO recommends that all integrated circuits be handled with appropriate precautions. Failure to observe proper handling and installation procedures can cause damage. ESD damage can range from subtle performance degradation to complete device failure. Precision integrated circuits may be more susceptible to damage because very small parametric changes could cause the device not to meet its published specifications.

SGMICRO reserves the right to make any change in circuit design, specification or other related things if necessary without notice at any time. Please contact SGMICRO sales office to get the latest datasheet.

PIN CONFIGURATIONS (TOP VIEW)

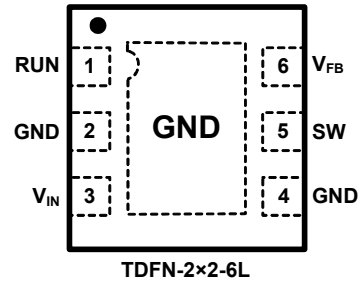
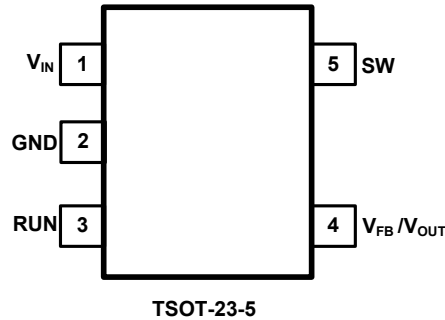

PIN DESCRIPTION

PIN		NAME	FUNCTION
TSOT-23-5	TDFN-2x2-6L		
1	3	V _{IN}	Supply Voltage Pin. Must be closely decoupled to GND, with a 4.7μF or greater ceramic capacitor.
2	2, 4	GND	Ground.
3	1	RUN	Run Control Input. Forcing this pin above 1.5V enables the part. Forcing this pin below 0.3V shuts down the device. In shutdown, all functions are disabled drawing <1μA supply current. Do not leave RUN floating.
4	6	V _{FB}	Feedback Pin. Receives the feedback voltage from an external resistive divider across the output. The internal voltage divider is disabled for this adjustable version. (SGM6013-ADJ)
	—	V _{OUT}	Output Voltage Feedback Pin. An internal resistive divider divides the output voltage down for comparison to the internal reference voltage. (SGM6013-1.2/SGM6013-1.8/SGM6013-3.3)
5	5	SW	Switch Node Connection to Inductor. This pin connects to the drains of the internal main and synchronous power MOSFET switches.

ELECTRICAL CHARACTERISTICS(V_{IN} = 3.6V, L = 2.2μH, C_{IN} = 4.7μF, C_{OUT} = 10μF, Full = -40°C to +85°C, typical values are at T_A = +25°C, unless otherwise noted.)

PARAMETER		SYMBOL	CONDITIONS	TEMP	MIN	TYP	MAX	UNITS	
Input Voltage Range		V _{IN}		Full	2.5		5.5	V	
Feedback Current		I _{VFB}		Full		±1	±100	nA	
Regulated Feedback Voltage		V _{F_{FB}}		Full	0.580	0.600	0.622	V	
				+25°C	0.583	0.600	0.620		
				0°C ≤ T _A ≤ +85°C	0.582	0.600	0.621		
Reference Voltage Line Regulation		ΔV _{F_{FB}}	V _{IN} = 2.5V to 5.5V	Full		0.1	0.6	%/V	
Regulated Output Voltage		V _{OUT}	SGM6013-1.2	I _{OUT} = 100mA	Full	1.159	1.200	1.241	V
			SGM6013-1.8	I _{OUT} = 100mA		1.739	1.800	1.861	
			SGM6013-3.3	I _{OUT} = 100mA		3.188	3.300	3.412	
Output Voltage Line Regulation		ΔV _{OUT}	V _{IN} = 2.5V to 5.5V	Full		0.1	0.6	%/V	
Peak Inductor Current		I _{PK}	V _{F_{FB}} = 0.5V or V _{OUT} = 90%, V _{IN} = 3V	+25°C		1	1.25	A	
Output Voltage Load Regulation		V _{LOADREG}		+25°C		0.5		%	
SW Leakage Current		I _{SW}	V _{RUN} = 0V, V _{SW} = 0V or 5V, V _{IN} = 5V	+25°C		±0.01	±1	μA	
Supply Current	PWM Mode	I _S	V _{F_{FB}} = 0.5V or V _{OUT} = 90%, I _{LOAD} = 0A	+25°C		280	360	μA	
	PFM Mode		V _{F_{FB}} = 0.62V or V _{OUT} = 103%, I _{LOAD} = 0A			30	56		
	Shutdown		V _{RUN} = 0V, V _{IN} = 4.2V			0.1	1		
RUN Threshold		V _{I_H}		Full	1.5			V	
		V _{I_L}					0.3		
RUN Leakage Current		I _{RUN}		Full		±0.01	±1	μA	
Oscillator Frequency		f _{OSC}	V _{F_{FB}} = 0.6V or V _{OUT} = 100%	Full	1.3	1.6	1.9	MHz	
			V _{F_{FB}} = 0V or V _{OUT} = 0V	+25°C		200		kHz	
R _{DS(ON)} of P-Channel FET		R _{PFET}	I _{SW} = 100mA	+25°C		0.46	0.65	Ω	
R _{DS(ON)} of N-Channel FET		R _{NFET}	I _{SW} = -100mA	+25°C		0.36	0.56	Ω	
PFM/PWM Mode Switch Point				+25°C		40		mA	

TYPICAL PERFORMANCE CHARACTERISTICS

T_A = +25°C, L = 2.2µH, C_{IN} = 4.7µF, C_{OUT} = 10µF, unless otherwise noted.

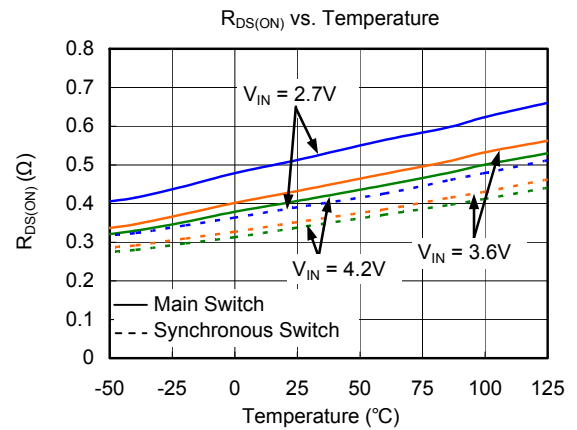
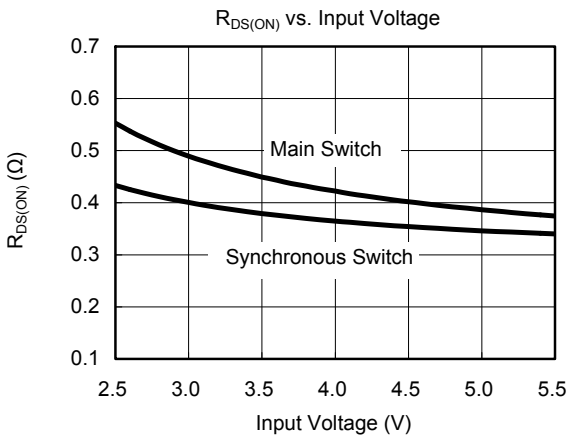
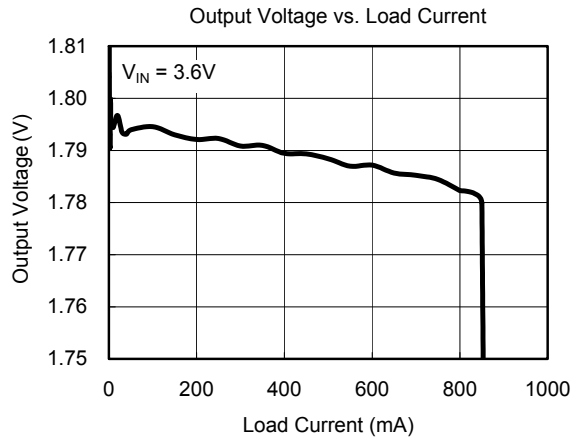
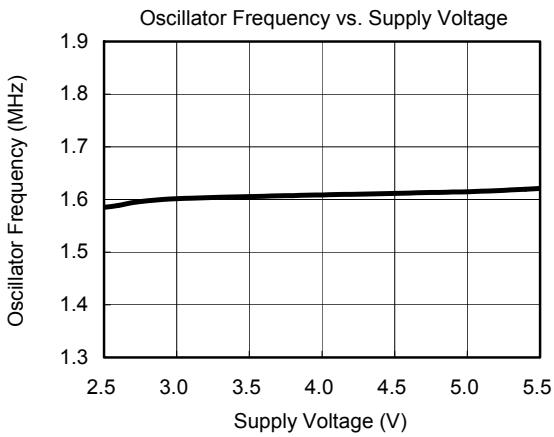
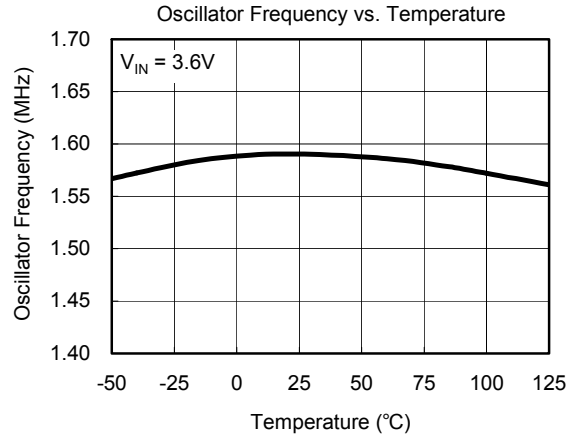
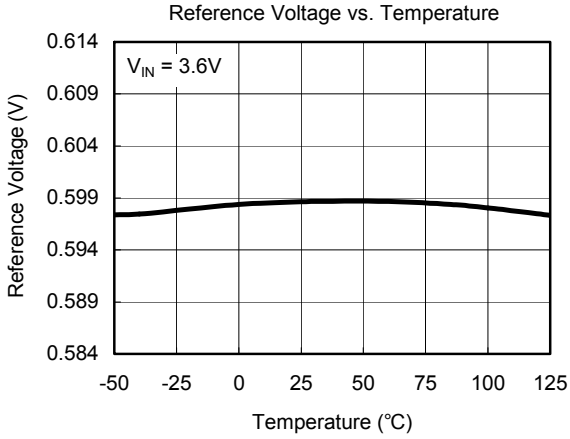

TYPICAL PERFORMANCE CHARACTERISTICS

$T_A = +25^\circ\text{C}$, $L = 2.2\mu\text{H}$, $C_{IN} = 4.7\mu\text{F}$, $C_{OUT} = 10\mu\text{F}$, unless otherwise noted.

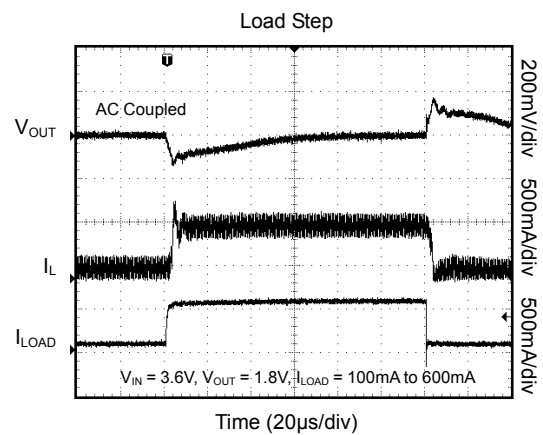
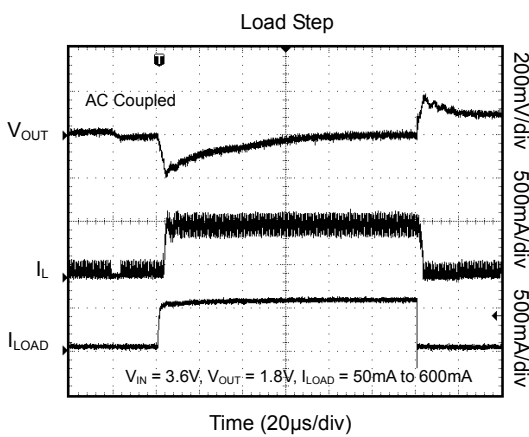
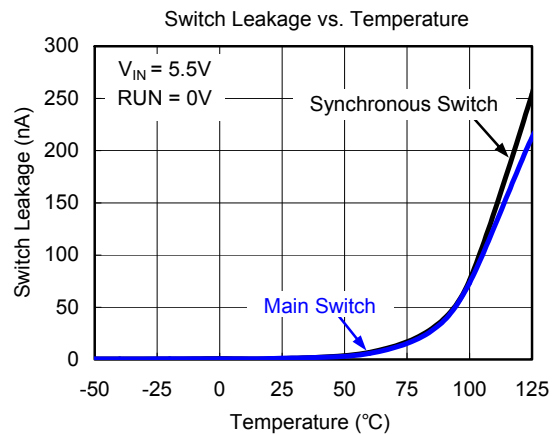
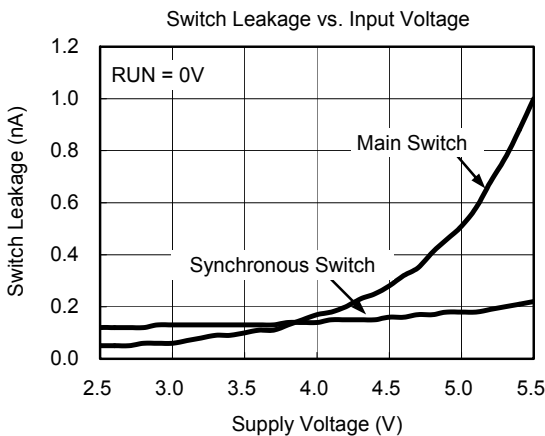
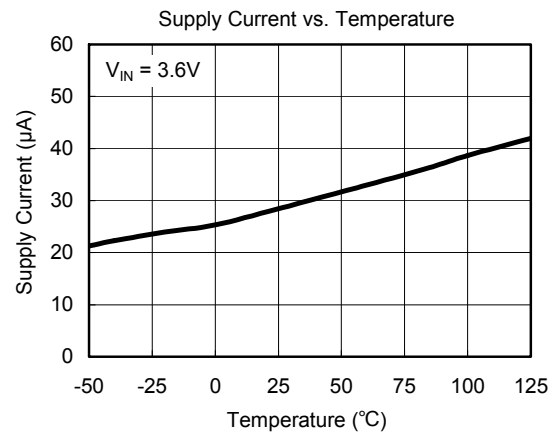
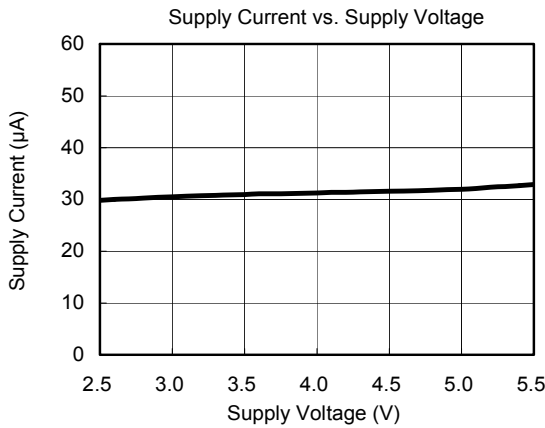

TYPICAL PERFORMANCE CHARACTERISTICS

$T_A = +25^\circ\text{C}$, $L = 2.2\mu\text{H}$, $C_{IN} = 4.7\mu\text{F}$, $C_{OUT} = 10\mu\text{F}$, unless otherwise noted.

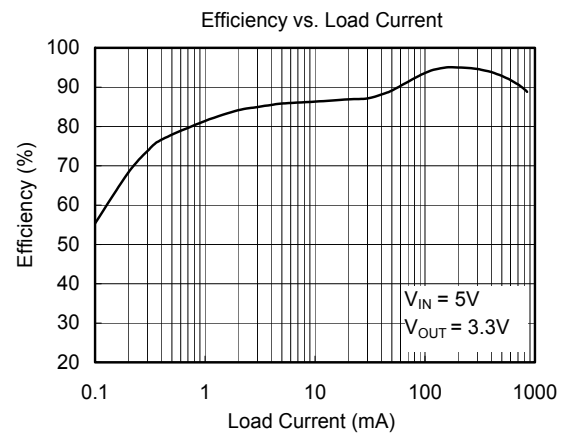
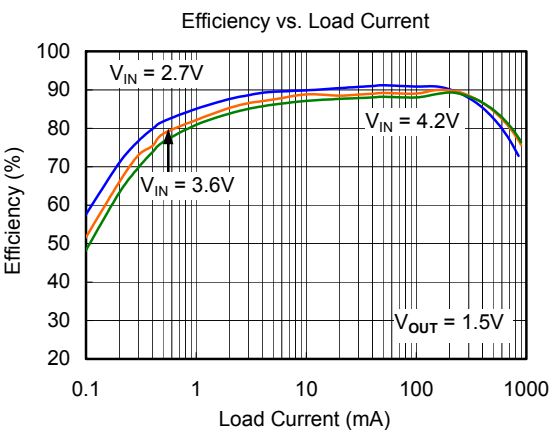
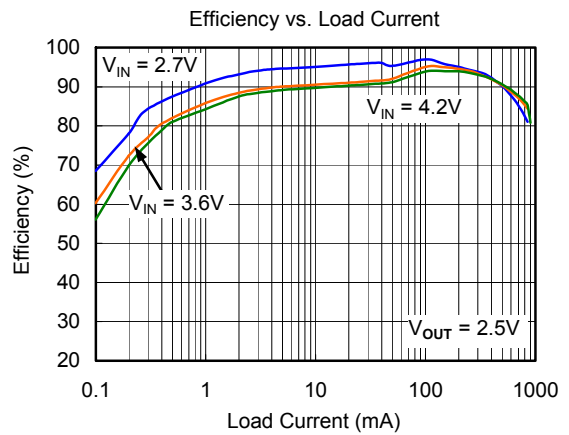
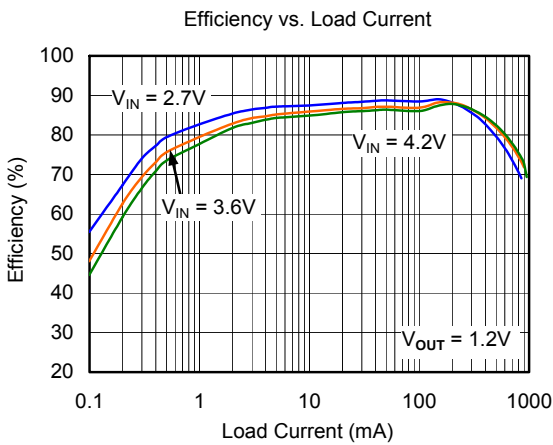
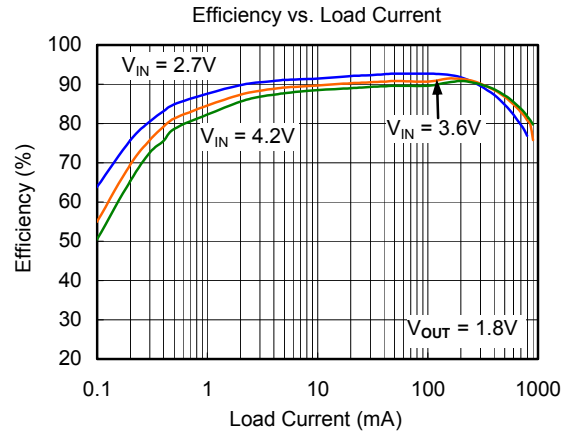
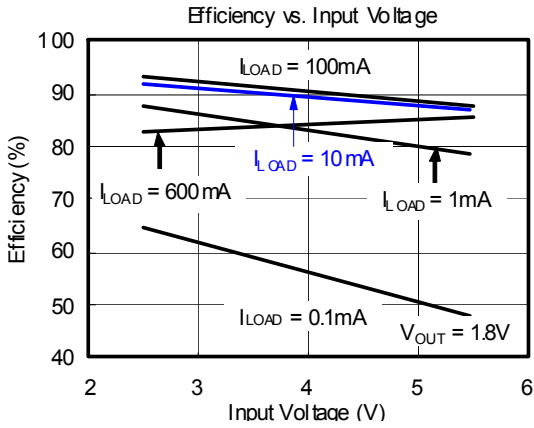

TYPICAL PERFORMANCE CHARACTERISTICS

$T_A = +25^\circ\text{C}$, $L = 2.2\mu\text{H}$, $C_{IN} = 4.7\mu\text{F}$, $C_{OUT} = 10\mu\text{F}$, unless otherwise noted.

PWM Mode Operation

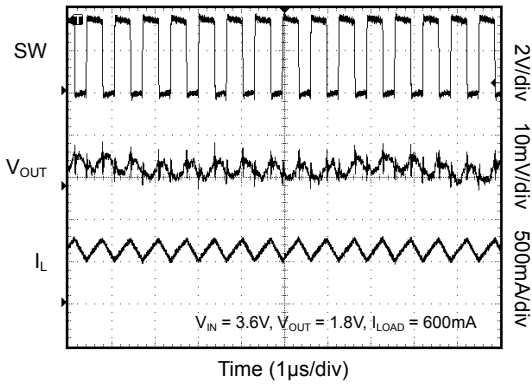

Light Load Operation

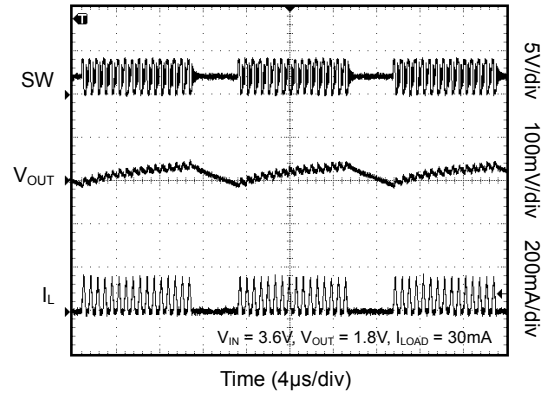

Start-Up from Shutdown

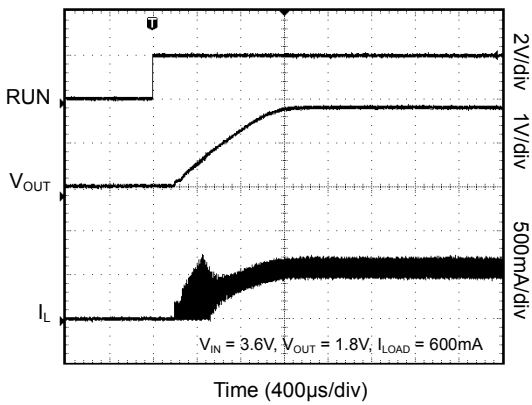

TYPICAL APPLICATION CIRCUITS

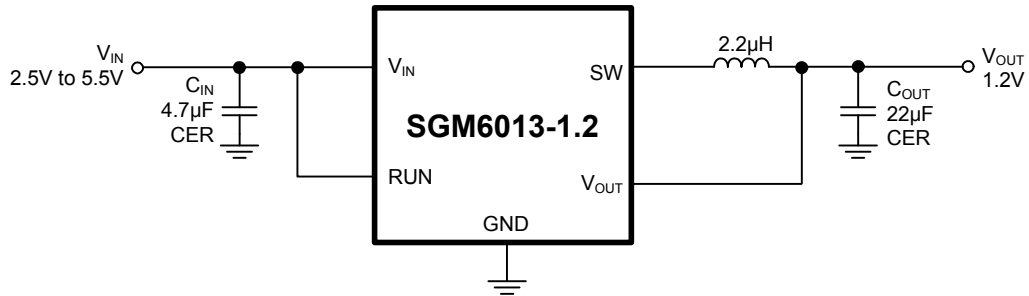

Figure 1. Single Li-ion 1.2V/800mA Regulator for High Efficiency and Small Footprint

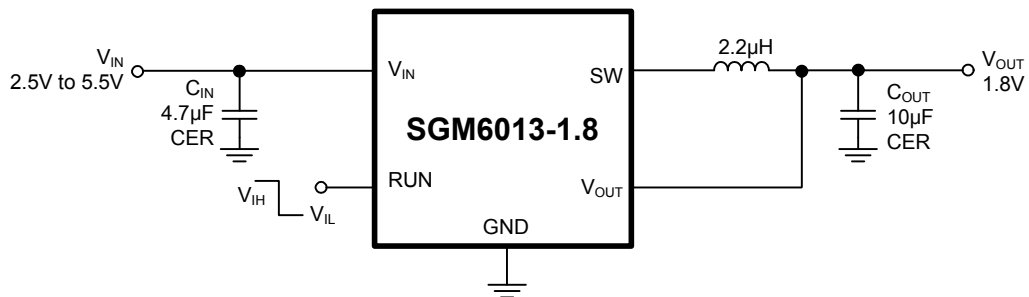

Figure 2. Single Li-ion 1.8V/800mA Regulator for High Efficiency and Small Footprint

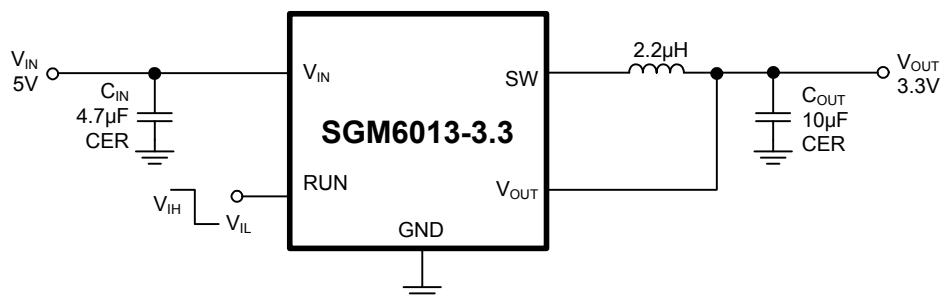

Figure 3. Tiny 3.3V/800mA Buck Regulator for High Efficiency and Small Footprint

TYPICAL APPLICATION CIRCUITS

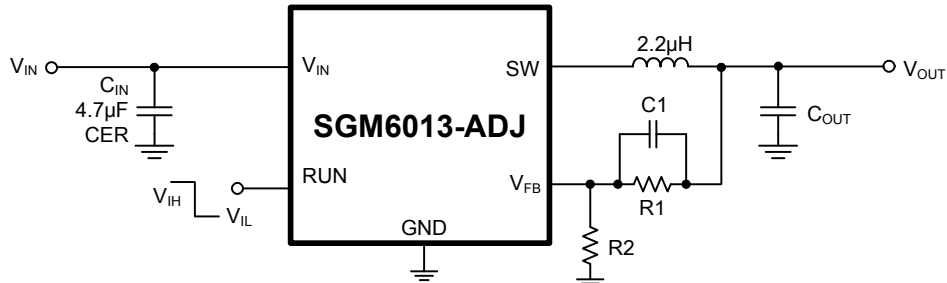

Figure 4. Basic Application Circuit with Adjustable Version

Table 1. Standard 1% Resistor Values for Output Voltages of Adjustable Voltage Version

V _{IN}	V _{OUT} (V)	C _{OUT} (µF)	C1 (pF)	R1 (kΩ)	R2 (kΩ)
2.5V to 5.5V	1.2	22	18	300	300
2.5V to 5.5V	1.3	22	18	301	261
2.5V to 5.5V	1.5	22	18	300	200
2.5V to 5.5V	1.8	10	18	300	150
V _{OUT} to 5.5V	2.5	10	18	301	95.3
V _{OUT} to 5.5V	2.7	10	18	301	86.6
V _{OUT} to 5.5V	2.8	10	18	301	82.5
V _{OUT} to 5.5V	3	10	18	300	75
V _{OUT} to 5.5V	3.1	10	18	300	72
V _{OUT} to 5.5V	3.3	10	18	300	66.5

NOTE: It is recommended to use a ceramic capacitor (C1) to obtain the best load transient response.

APPLICATION INFORMATION

The basic SGM6013 application circuits are shown in Figure 1, 2, 3 and 4. External component selection is driven by the load requirement and begins with the selection of L followed by C_{IN} and C_{OUT} .

Inductor Selection

For most applications, the value of the inductor will fall in the range of $1\mu\text{H}$ to $4.7\mu\text{H}$. Its value is chosen based on the desired ripple current. Large value inductors lower ripple current and small value inductors result in higher ripple currents. Higher V_{IN} or V_{OUT} also increases the ripple current as shown in equation 1. A reasonable starting point for setting ripple current is $\Delta I_L = 240\text{mA}$ (30% of 800mA).

$$\Delta I_L = \frac{1}{(f)(L)} V_{OUT} \left(1 - \frac{V_{OUT}}{V_{IN}} \right) \quad (1)$$

The DC current rating of the inductor should be at least equal to the maximum load current plus half the ripple current to prevent core saturation. Thus, a 920mA rated inductor should be enough for most applications (800mA + 120mA). For better efficiency, choose a low DC-resistance inductor.

The inductor value also has an effect on power saving mode operation. The transition to low current operation begins when the inductor current peaks fall to approximately 100mA. Lower inductor values (higher ΔI_L) will cause this to occur at lower load currents, which can cause a dip in efficiency in the upper range of low current operation. In power saving mode operation, lower inductance values will cause the burst frequency to increase.

Inductor Core Selection

Different core materials and shapes will change the size/current and price/current relationship of an inductor. Toroid or shielded pot cores in ferrite or permalloy materials are small and don't radiate much energy, but generally cost more than powdered iron core inductors with similar electrical characteristics. The choice of which style inductor to use often depends more on the price vs size requirements and any radiated field/EMI requirements than on what the SGM6013 requires to operate.

C_{IN} and C_{OUT} Selection

In continuous mode, the source current of the top MOSFET is a square wave of duty cycle V_{OUT}/V_{IN} . To prevent large voltage transients, a low ESR input capacitor sized for the maximum RMS current must be used. The maximum RMS capacitor current is given by:

$$C_{IN} \text{ required } I_{RMS} \cong I_{OMAX} \frac{[V_{OUT}(V_{IN} - V_{OUT})]^{1/2}}{V_{IN}}$$

This formula has a maximum at $V_{IN} = 2V_{OUT}$, where $I_{RMS} = I_{OUT}/2$. This simple worst-case condition is commonly used for design because even significant deviations do not offer much relief. Note that the capacitor manufacturer's ripple current ratings are often based on 2000 hours of life. This makes it advisable to further derate the capacitor, or choose a capacitor rated at a higher temperature than required. Always consult the manufacturer if there is any question.

The selection of C_{OUT} is driven by the required effective series resistance (ESR).

Typically, once the ESR requirement for C_{OUT} has been met, the RMS current rating generally far exceeds the $I_{RIPPLE(P-P)}$ requirement. The output ripple ΔV_{OUT} is determined by:

$$\Delta V_{OUT} \cong \Delta I_L \left(\text{ESR} + \frac{1}{8fC_{OUT}} \right)$$

where f = operating frequency, C_{OUT} = output capacitance and ΔI_L = ripple current in the inductor. For a fixed output voltage, the output ripple is highest at maximum input voltage since ΔI_L increases with input voltage.

Aluminum electrolytic and dry tantalum capacitors are both available in surface mount configurations. In the case of tantalum, it is critical that the capacitors be surge tested for use in switching power supplies. An excellent choice is the AVX TPS series of surface mount tantalum. These are specially constructed and tested for low ESR so they give the lowest ESR for a given volume. Other capacitor types include Sanyo POSCAP, Kemet T510 and T495 series.

APPLICATION INFORMATION

Using Ceramic Input and Output Capacitors

Higher values, lower cost ceramic capacitors are now becoming available in smaller case sizes. Their high ripple current, high voltage rating and low ESR make them ideal for switching regulator applications. Because the SGM6013's control loop does not depend on the output capacitor's ESR for stable operation, ceramic capacitors can be used freely to achieve very low output ripple and small circuit size.

However, care must be taken when ceramic capacitors are used at the input and the output. When a ceramic capacitor is used at the input and the power is supplied by a wall adapter through long wires, a load step at the output can induce ringing at the input, V_{IN} . At best, this ringing can couple to the output and be mistaken as loop instability. At worst, a sudden inrush of current through the long wires can potentially cause a voltage spike at V_{IN} , large enough to damage the part.

When choosing the input and output ceramic capacitors, choose the X5R or X7R dielectric formulations. These dielectrics have the best temperature and voltage characteristics of all the ceramics for a given value and size.

Output Voltage Programming

In the adjustable version, the output voltage is set by a resistive divider according to the following formula:

$$V_{OUT} = 0.6V \left(1 + \frac{R1}{R2} \right) \quad (2)$$

The external resistive divider is connected to the output, allowing remote voltage sensing as shown in Figure 5.

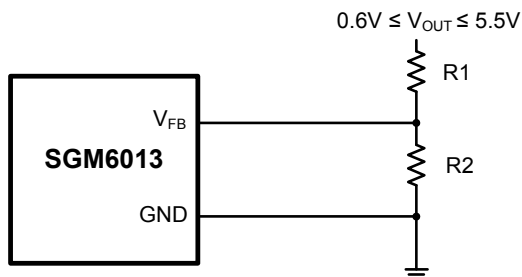

Figure 5. Setting the SGM6013 Output Voltage

Thermal Considerations

In most applications the SGM6013 does not dissipate much heat due to its high efficiency. But, in applications where the SGM6013 is running at high ambient temperature with low supply voltage and high duty cycles, such as in dropout, the heat dissipated may exceed the maximum junction temperature of the part. If the junction temperature reaches approximately 150°C, both power switches will be turned off and the SW node will become high impedance.

To avoid the SGM6013 from exceeding the maximum junction temperature, the user will need to do some thermal analysis. The goal of the thermal analysis is to determine whether the power dissipated exceeds the maximum junction temperature of the part. The temperature rise is given by:

$$T_R = (P_D)(\theta_{JA})$$

where P_D is the power dissipated by the regulator and θ_{JA} is the thermal resistance from the junction of the die to the ambient temperature. The junction temperature, T_J , is given by: $T_J = T_A + T_R$ where T_A is the ambient temperature.

APPLICATION INFORMATION

PC Board Layout Guidelines

When laying out the printed circuit board, the following guidelines should be used to ensure proper operation of the SGM6013. These items are also illustrated graphically in Figures 6. Check the following in your layout:

1. Keep the traces of V_{IN} , GND and SW short and wide.
2. Connect the V_{FB} pin directly to the feedback resistors. The resistive divider R2/R1 must be connected between the (+) plate of C_{OUT} and ground.
3. Connect the (+) plate of C_{IN} as closely to V_{IN} as possible.
4. Keep the switching node, SW, away from the sensitive V_{FB} node.
5. Keep the (-) plates of C_{IN} and C_{OUT} as close as possible.

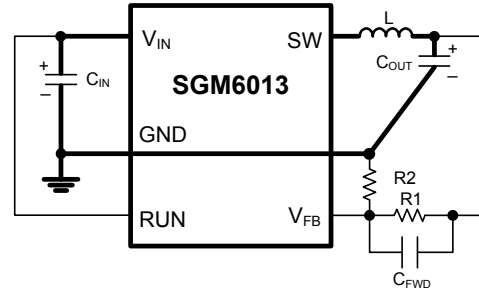

Figure 6a. SGM6013 Layout Diagram (TSOT-23-5)

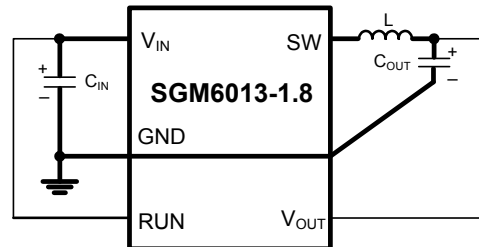

Figure 6b. SGM6013-1.8 Layout Diagram (TSOT-23-5)

APPLICATION INFORMATION

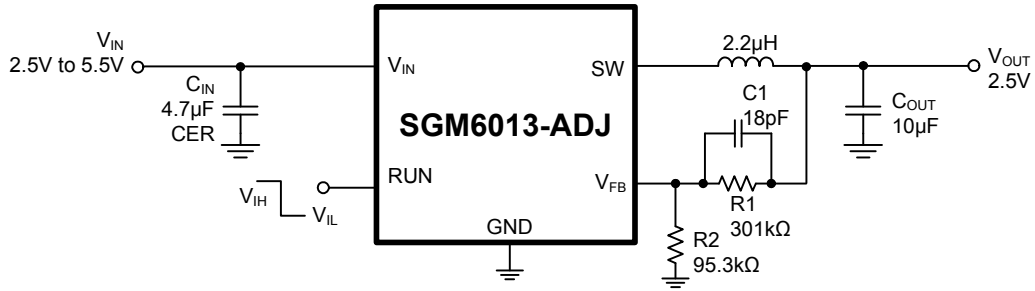

Figure 7a

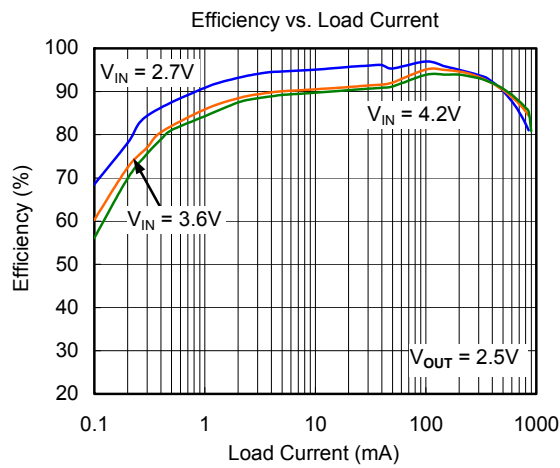
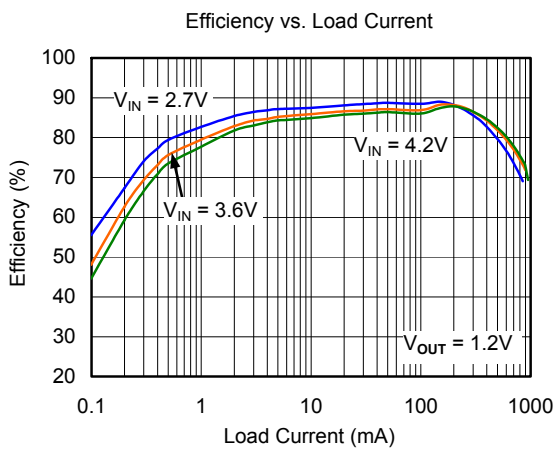
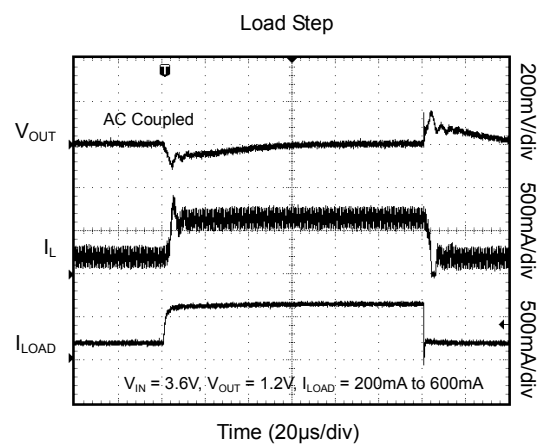
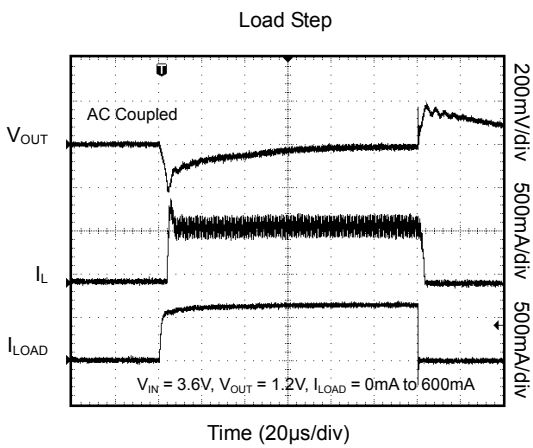
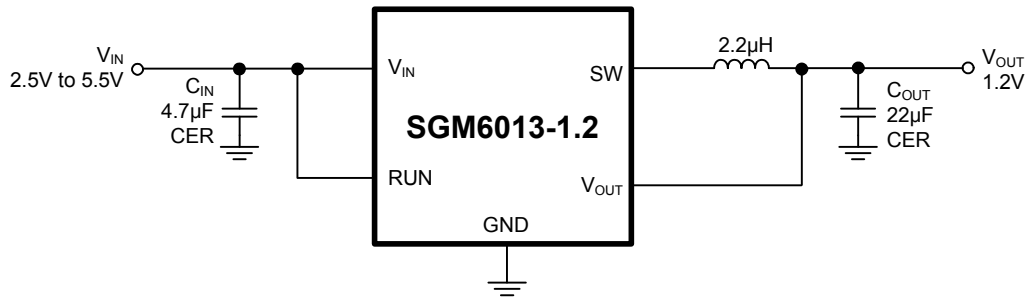

Figure 7b

Figure 7 shows the complete circuit along with its efficiency curve.

TYPICAL APPLICATIONS

Single Li-ion 1.2V/800mA Regulator for High Efficiency and Small Footprint



TYPICAL APPLICATIONS

Single Li-ion 1.8V/800mA Regulator for High Efficiency and Small Footprint

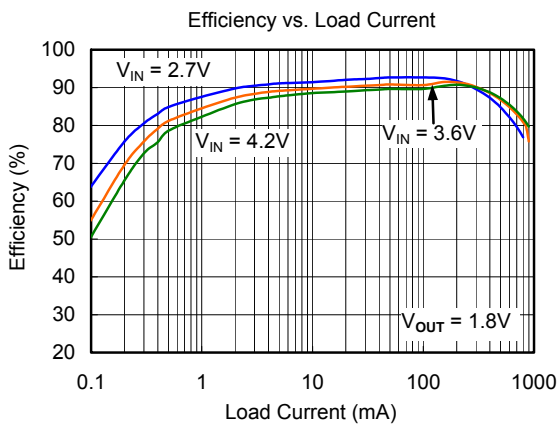
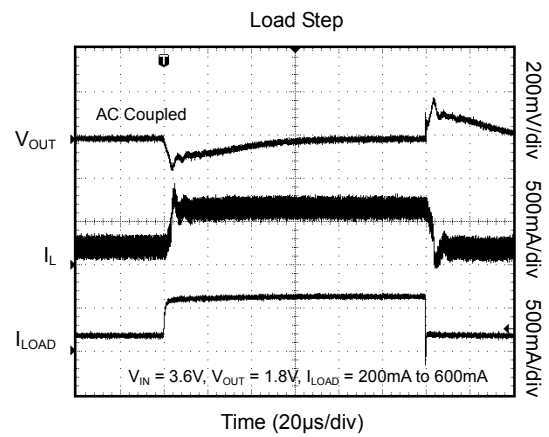
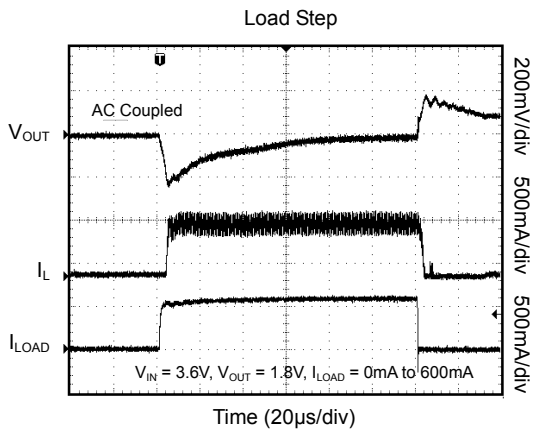
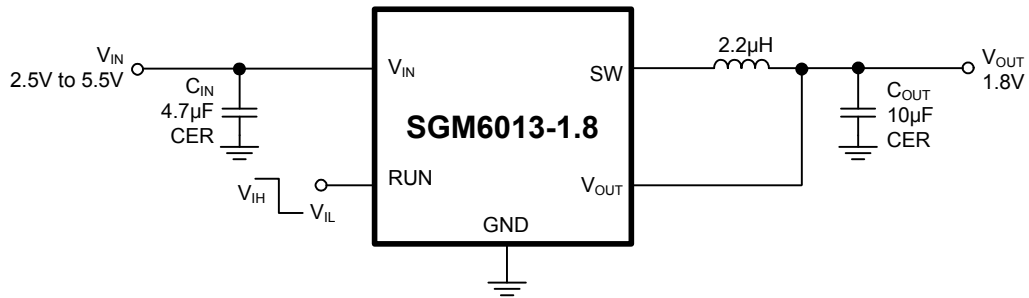

TYPICAL APPLICATIONS

Tiny 3.3V/800mA Buck Regulator for High Efficiency and Small Footprint

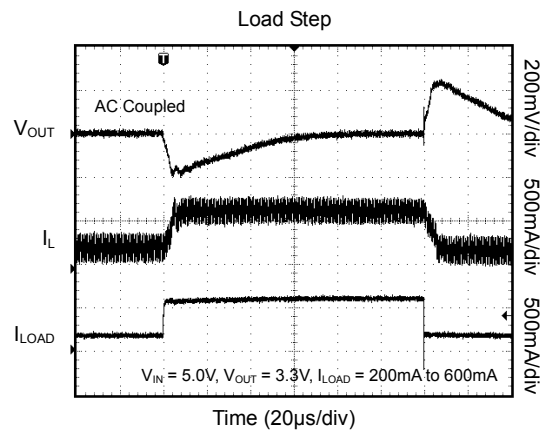
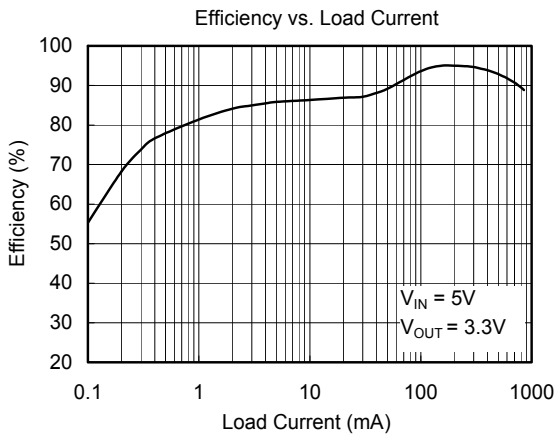
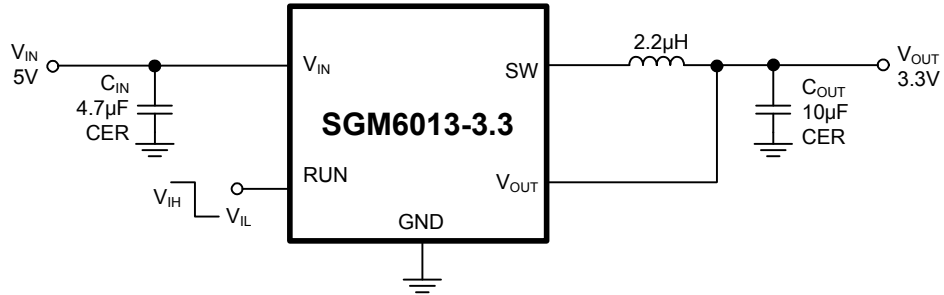

TYPICAL APPLICATIONS

Basic Application Circuit with Adjustable Version

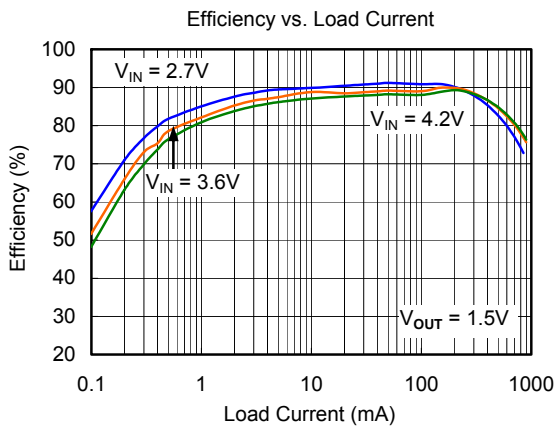
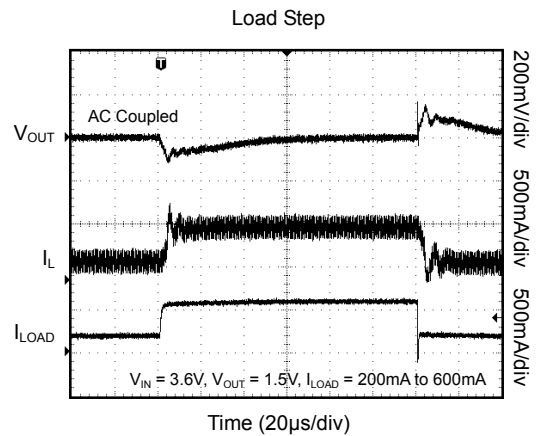
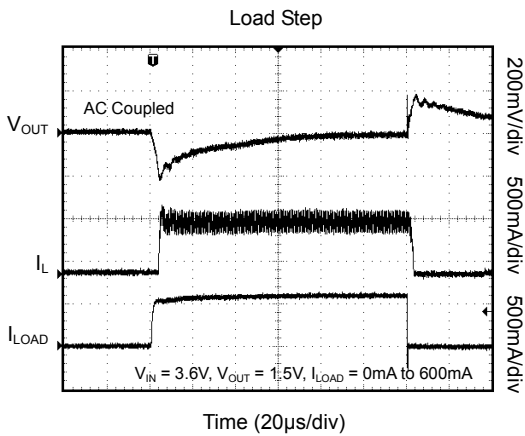
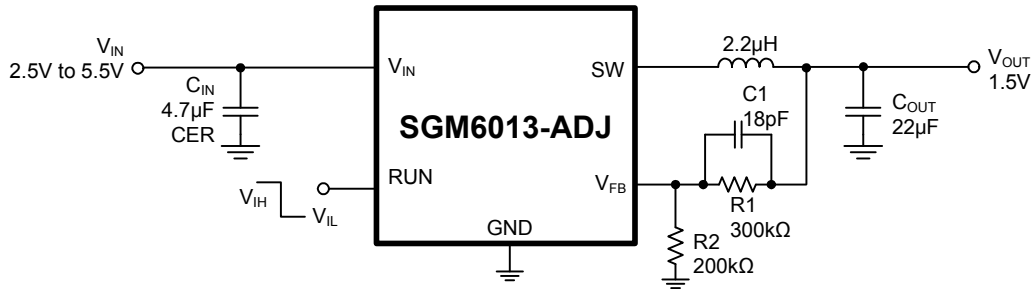

PACKAGE OUTLINE DIMENSIONS

TSOT-23-5

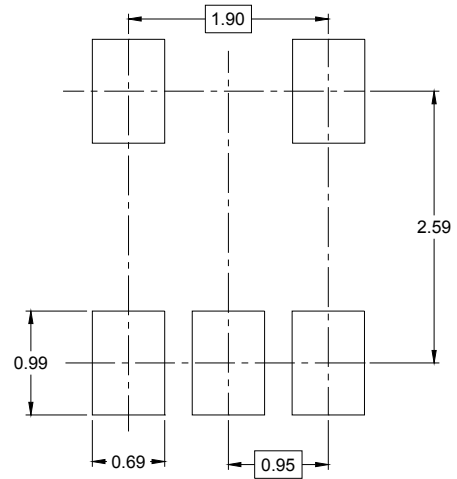
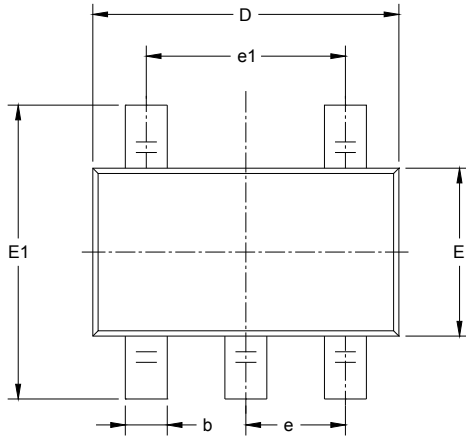

RECOMMENDED LAND PATTERN (Unit: mm)

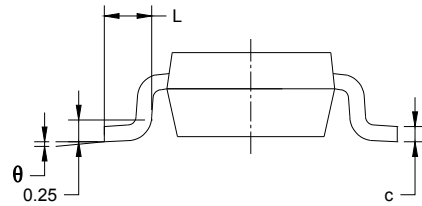
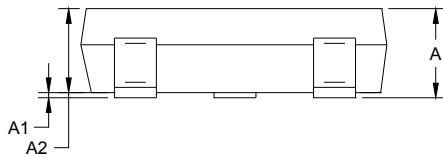

Symbol	Dimensions In Millimeters		Dimensions In Inches	
	MIN	MAX	MIN	MAX
A	0.700	0.900	0.028	0.035
A1	0.000	0.100	0.000	0.004
A2	0.700	0.800	0.028	0.031
b	0.350	0.500	0.014	0.020
c	0.080	0.200	0.003	0.008
D	2.820	3.020	0.111	0.119
E	1.600	1.700	0.063	0.067
E1	2.650	2.950	0.104	0.116
e	0.950 BSC		0.037 BSC	
e1	1.900 BSC		0.075 BSC	
L	0.300	0.600	0.012	0.024
θ	0°	8°	0°	8°

PACKAGE OUTLINE DIMENSIONS

TDFN-2x2-6L

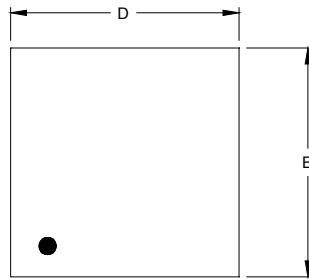

TOP VIEW

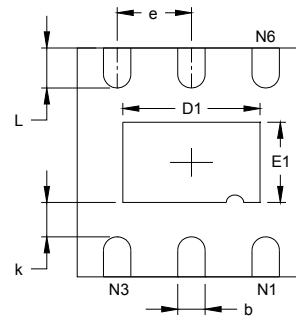

BOTTOM VIEW

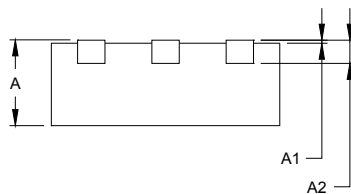

SIDE VIEW

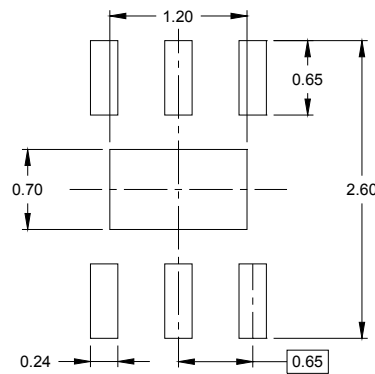

RECOMMENDED LAND PATTERN (Unit: mm)

Symbol	Dimensions In Millimeters		Dimensions In Inches	
	MIN	MAX	MIN	MAX
A	0.700	0.800	0.028	0.031
A1	0.000	0.050	0.000	0.002
A2	0.203 REF		0.008 REF	
D	1.900	2.100	0.075	0.083
D1	1.100	1.300	0.043	0.051
E	1.900	2.100	0.075	0.083
E1	0.600	0.800	0.024	0.031
k	0.200 MIN		0.008 MIN	
b	0.180	0.300	0.007	0.012
e	0.650 TYP		0.026 TYP	
L	0.250	0.450	0.010	0.018

TAPE AND REEL INFORMATION

REEL DIMENSIONS

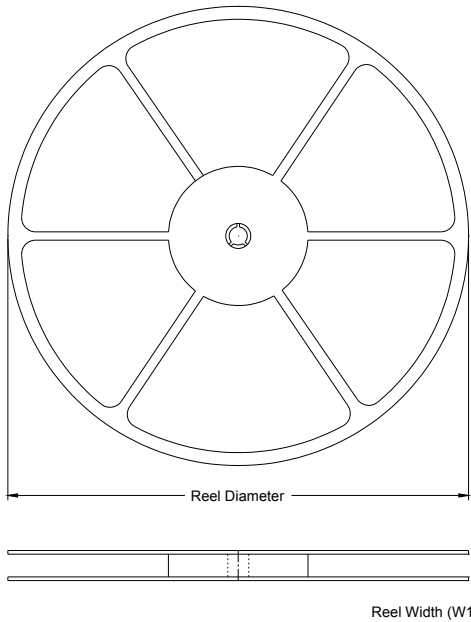

TAPE DIMENSIONS

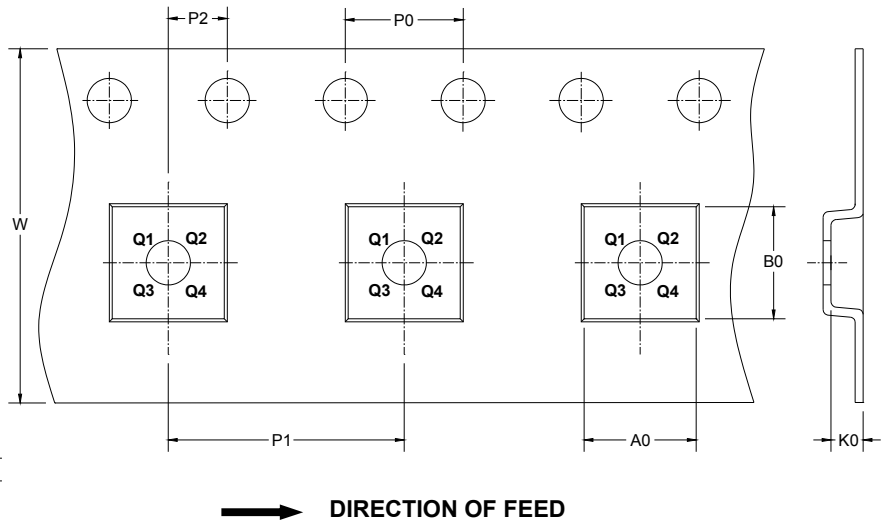

NOTE: The picture is only for reference. Please make the object as the standard.

KEY PARAMETER LIST OF TAPE AND REEL

Package Type	Reel Diameter	Reel Width W1 (mm)	A0 (mm)	B0 (mm)	K0 (mm)	P0 (mm)	P1 (mm)	P2 (mm)	W (mm)	Pin1 Quadrant
TSOT-23-5	7"	9.5	3.17	3.1	1.10	4.0	4.0	2.0	8.0	Q3
TDFN-2x2-6L	7"	9.5	2.30	2.30	1.10	4.00	4.00	2.00	8.00	Q1

SGM6013

1.6MHz, 800mA Synchronous Step-Down Converter

CARTON BOX DIMENSIONS

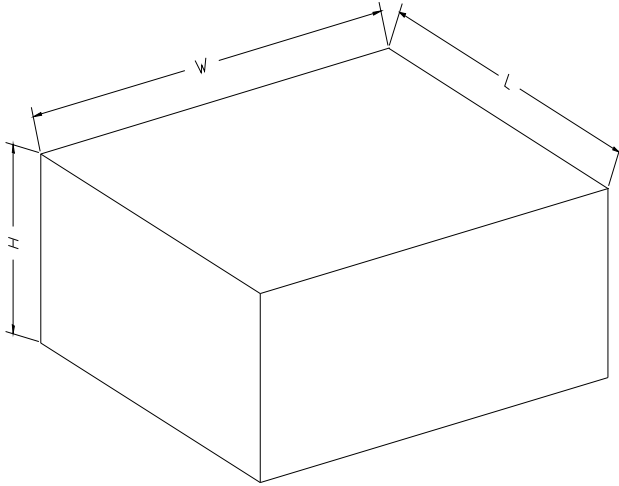

NOTE: The picture is only for reference. Please make the object as the standard.

KEY PARAMETER LIST OF CARTON BOX

Reel Type	Length (mm)	Width (mm)	Height (mm)	Pizza/Carton
7" (Option)	368	227	224	8
7"	442	410	224	18