

### GENERAL DESCRIPTION

The SGM8198 is a single, high-side, high speed, current shunt monitor that operates from 2.7V to 36V single supply, consuming only 65 $\mu$ A quiescent current. The device also features a wide common mode voltage range from 2.7V to 36V. Therefore, either side of the shunt current can be connected to the power supply, and the error is minimized.

The SGM8198 is designed to set any gain from 1 to 100 or more with one external resistor. Differential input voltage can be converted into output current, and the output current is converted back to voltage through load resistance. The device is very suitable for applications in many circuits requiring current shunt measurement or level shifting.

The SGM8198 is available in a Green SOT-23-5 package. It is specified for the -40 $^{\circ}$ C to +125 $^{\circ}$ C temperature range.

### FEATURES

- **High-side Current Measurement**
- **Wide Supply Voltage Range: 2.7V to 36V**
- **Wide Input Common Mode Voltage: 2.7V to 36V**
- **Low Quiescent Current: 65 $\mu$ A (TYP)**
- **Set Gain with One External Resistor**
- **-40 $^{\circ}$ C to +125 $^{\circ}$ C Operating Temperature Range**
- **Available in a Green SOT-23-5 Package**

### APPLICATIONS

Current Shunt Measurements  
Energy Managements  
Battery Chargers  
Portable Equipment  
Servers

**PACKAGE/ORDERING INFORMATION**

MODEL	PACKAGE DESCRIPTION	SPECIFIED TEMPERATURE RANGE	ORDERING NUMBER	PACKAGE MARKING	PACKING OPTION
SGM8198	SOT-23-5	-40°C to +125°C	SGM8198XN5G/TR	GMCXX	Tape and Reel, 3000

**MARKING INFORMATION**

NOTE: XX = Date Code.

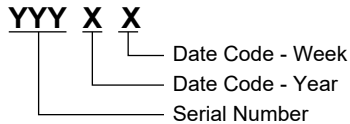

Green (RoHS & HSF): SG Micro Corp defines "Green" to mean Pb-Free (RoHS compatible) and free of halogen substances. If you have additional comments or questions, please contact your SGMICRO representative directly.

**ABSOLUTE MAXIMUM RATINGS**

Supply Voltage Range .....	-0.3V to 40V
Analog Inputs ( $V_{IN+}$ , $V_{IN-}$ ) Common Mode Voltage Range .....	-0.3V to 40V
Analog Output Voltage Range, $V_{OUT}$ .....	-0.3V to 40V
Input Current into Any Pin .....	10mA
Package Thermal Resistance	
SOT-23-5, $\theta_{JA}$ .....	199°C/W
Junction Temperature .....	+150°C
Storage Temperature Range .....	-65°C to +150°C
Lead Temperature (Soldering, 10s) .....	+260°C
ESD Susceptibility	
HBM .....	2000V
CDM .....	1000V

**RECOMMENDED OPERATING CONDITIONS**

Operating Voltage Range .....	2.7V to 36V
Operating Temperature Range .....	-40°C to +125°C

**OVERSTRESS CAUTION**

Stresses beyond those listed in Absolute Maximum Ratings may cause permanent damage to the device. Exposure to absolute maximum rating conditions for extended periods may affect reliability. Functional operation of the device at any conditions beyond those indicated in the Recommended Operating Conditions section is not implied.

**ESD SENSITIVITY CAUTION**

This integrated circuit can be damaged if ESD protections are not considered carefully. SGMICRO recommends that all integrated circuits be handled with appropriate precautions. Failure to observe proper handling and installation procedures can cause damage. ESD damage can range from subtle performance degradation to complete device failure. Precision integrated circuits may be more susceptible to damage because even small parametric changes could cause the device not to meet the published specifications.

**DISCLAIMER**

SG Micro Corp reserves the right to make any change in circuit design, or specifications without prior notice.

**PIN CONFIGURATION**

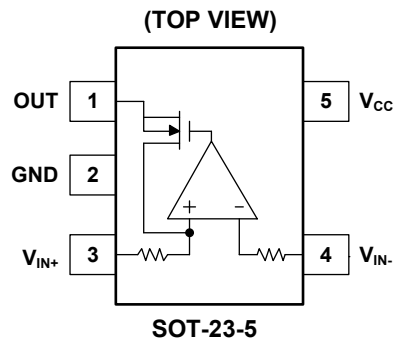

**ELECTRICAL CHARACTERISTICS**(At  $T_A = -40^{\circ}\text{C}$  to  $+125^{\circ}\text{C}$ ,  $V_{CC} = 5\text{V}$ ,  $V_{IN+} = 12\text{V}$  and  $R_L = 1\text{k}\Omega$ , unless otherwise noted.)

PARAMETER	SYMBOL	CONDITIONS	MIN	TYP	MAX	UNITS
<b>Input Characteristics</b>						
Full-Scale Sense Voltage		$V_{SENSE} = V_{IN+} - V_{IN-}$		100	500	mV
Input Offset Voltage RTI	$V_{OS}$	$V_{IN+} = 2.7\text{V}$ to $36\text{V}$		$\pm 30$	$\pm 550$	$\mu\text{V}$
Input Offset Voltage Drift	$\Delta V_{OS}/\Delta T$			1		$\mu\text{V}/^{\circ}\text{C}$
Input Bias Current	$I_B$			16		$\mu\text{A}$
Input Common Mode Voltage Range	$V_{CM}$		2.7		36	V
Common Mode Rejection Ratio	CMRR	$V_{IN+} = 2.7\text{V}$ to $36\text{V}$ , $V_{SENSE} = 50\text{mV}$	104	140		dB
<b>Output Characteristics</b>						
Transconductance	$g_m$	$V_{SENSE} = 10\text{mV}$ to $150\text{mV}$	990	1000	1010	$\mu\text{A}/\text{V}$
Transconductance vs. Temperature	$\Delta g_m/\Delta T$	$V_{SENSE} = 10\text{mV}$ to $150\text{mV}$		10		$\text{nA}/^{\circ}\text{C}$
Nonlinearity Error	INL	$V_{SENSE} = 10\text{mV}$ to $150\text{mV}$		$\pm 0.01$	$\pm 0.13$	%
Total Output Error		$V_{SENSE} = 100\text{mV}$		$\pm 0.25$	$\pm 1.8$	%
Output Voltage		Swing to power supply, $V_{CC}$	$V_{CC} - 1.85$	$V_{CC} - 1.6$		V
		Swing to common mode, $V_{CM}$	$V_{CM} - 1.25$	$V_{CM} - 1$		
<b>Power Supply</b>						
Operating Voltage Range	$V_{CC}$		2.7		36	V
Quiescent Current	$I_Q$	$V_{SENSE} = 0$ , $I_{OUT} = 0$		65	90	$\mu\text{A}$
Power Supply Rejection Ratio	PSRR	$V_{CC} = 2.7\text{V}$ to $36\text{V}$ , $V_{SENSE} = 50\text{mV}$		0.1	5	$\mu\text{V}/\text{V}$
<b>Frequency Response</b>						
Bandwidth	BW	$R_L = 10\text{k}\Omega$		480		kHz
		$R_L = 20\text{k}\Omega$		270		
Settling Time to 0.1%		5V step, $R_L = 10\text{k}\Omega$		15		$\mu\text{s}$
		5V step, $R_L = 20\text{k}\Omega$		15		
<b>Noise</b>						
Total Output Current Noise		BW = 100kHz		6		$\text{nA}_{\text{RMS}}$
Output Current Noise Density				20		$\text{pA}/\sqrt{\text{Hz}}$

TYPICAL PERFORMANCE CHARACTERISTICS

At  $T_A = +25^\circ\text{C}$ ,  $V_{CC} = 5\text{V}$ ,  $V_{IN+} = 12\text{V}$  and  $R_L = 1\text{k}\Omega$ , unless otherwise noted.

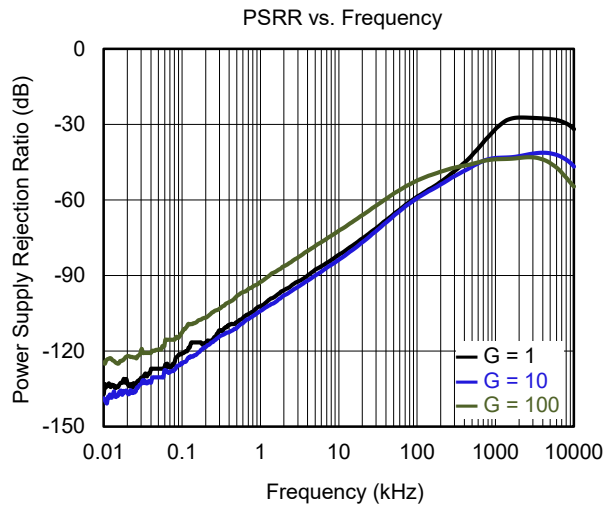
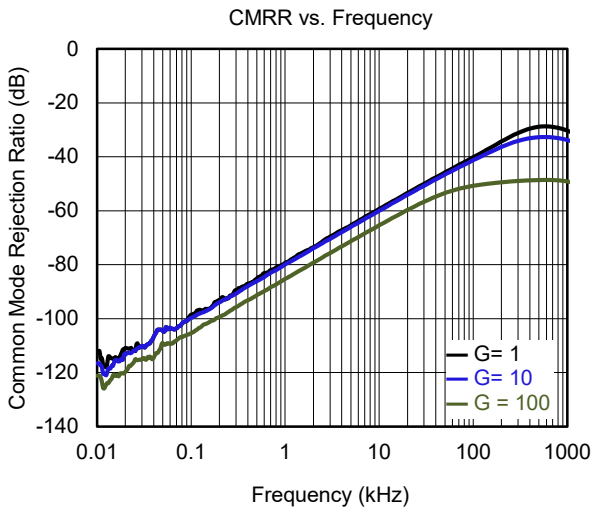
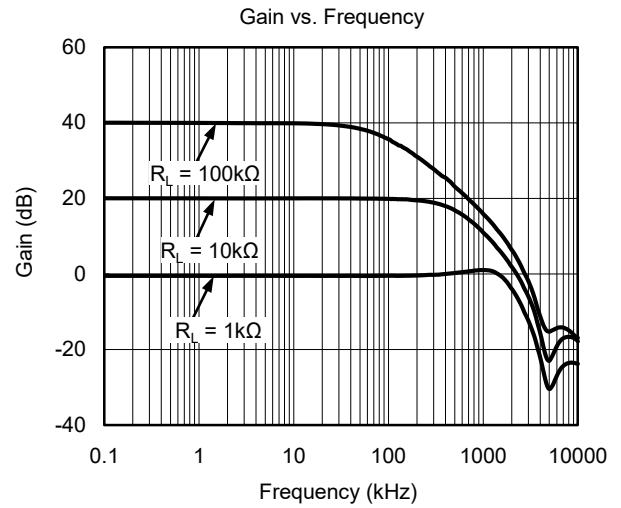
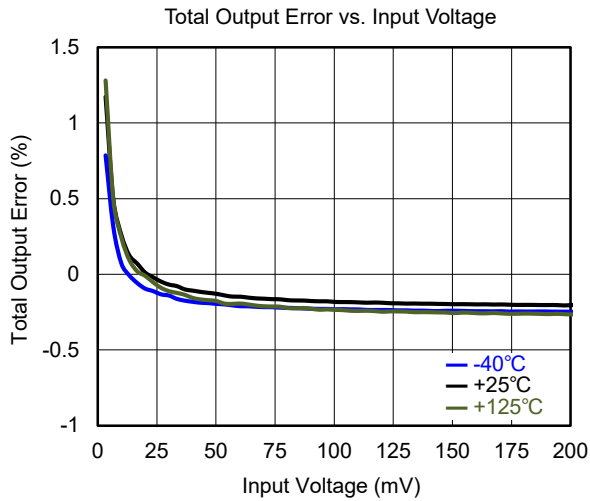
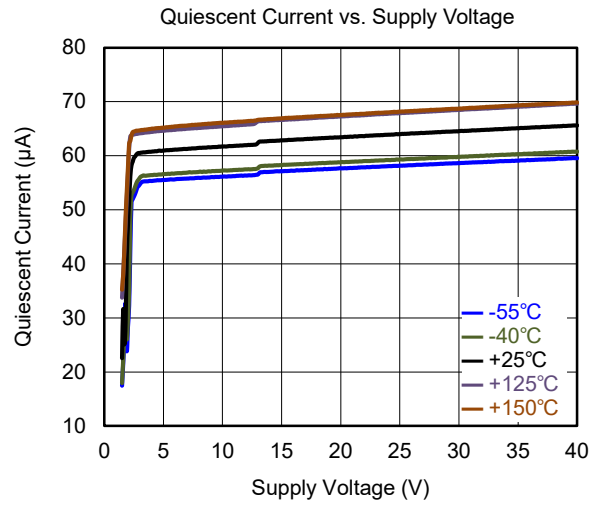
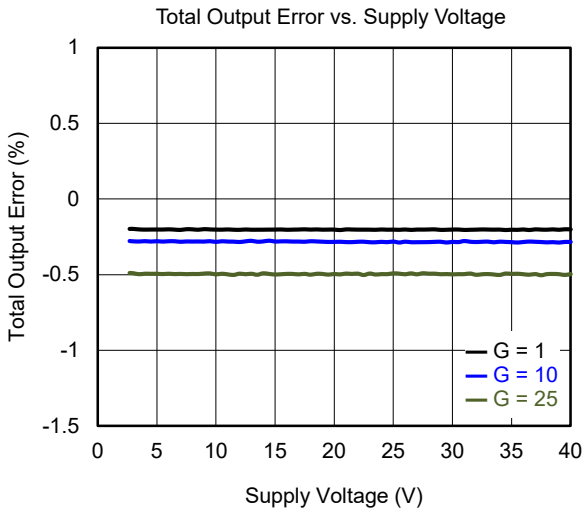

TYPICAL PERFORMANCE CHARACTERISTICS (continued)

At  $T_A = +25^\circ\text{C}$ ,  $V_{CC} = 5\text{V}$ ,  $V_{IN+} = 12\text{V}$  and  $R_L = 1\text{k}\Omega$ , unless otherwise noted.

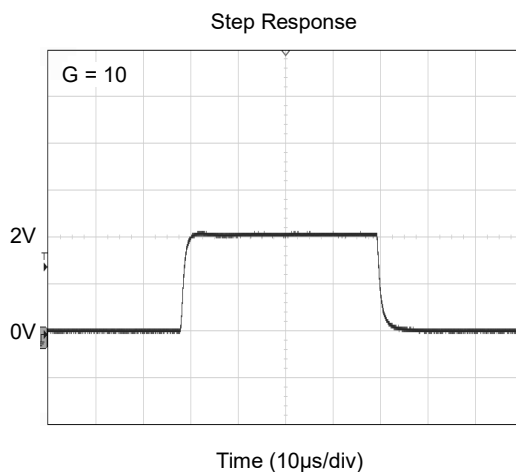
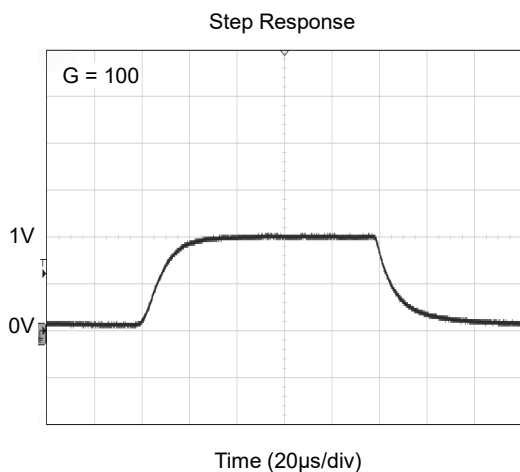
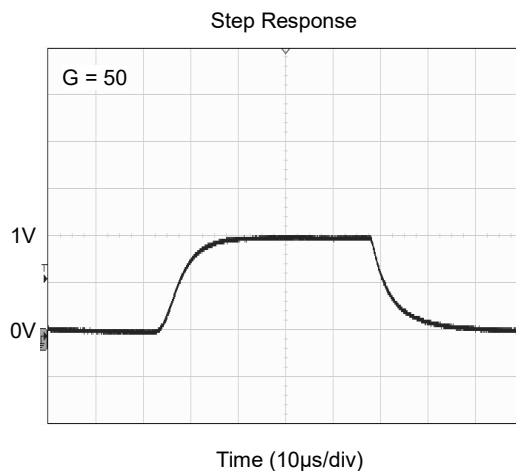
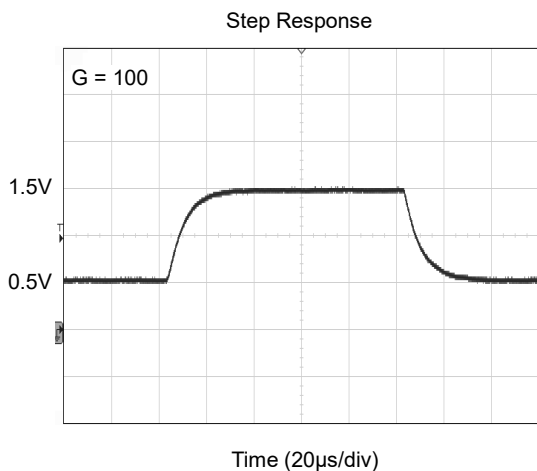

**REVISION HISTORY**

NOTE: Page numbers for previous revisions may differ from page numbers in the current version.

<b>JANUARY 2021 – REV.A.1 to REV.A.2</b>	<b>Page</b>
Updated Absolute Maximum Ratings section.....	2

---

<b>AUGUST 2019 – REV.A to REV.A.1</b>	<b>Page</b>
Updated Electrical Characteristics section.....	3

---

<b>Changes from Original (DECEMBER 2018) to REV.A</b>	<b>Page</b>
Changed from product preview to production data.....	All

---

PACKAGE OUTLINE DIMENSIONS

SOT-23-5

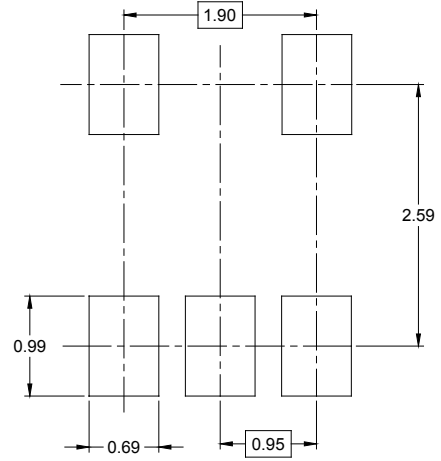
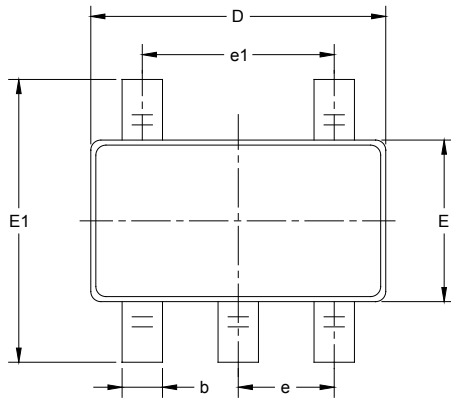

RECOMMENDED LAND PATTERN (Unit: mm)

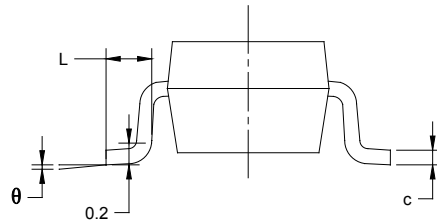
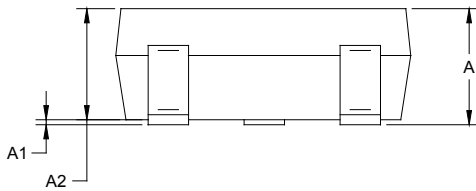

Symbol	Dimensions In Millimeters		Dimensions In Inches	
	MIN	MAX	MIN	MAX
A	1.050	1.250	0.041	0.049
A1	0.000	0.100	0.000	0.004
A2	1.050	1.150	0.041	0.045
b	0.300	0.500	0.012	0.020
c	0.100	0.200	0.004	0.008
D	2.820	3.020	0.111	0.119
E	1.500	1.700	0.059	0.067
E1	2.650	2.950	0.104	0.116
e	0.950 BSC		0.037 BSC	
e1	1.900 BSC		0.075 BSC	
L	0.300	0.600	0.012	0.024
$\theta$	0°	8°	0°	8°

# PACKAGE INFORMATION

## TAPE AND REEL INFORMATION

### REEL DIMENSIONS

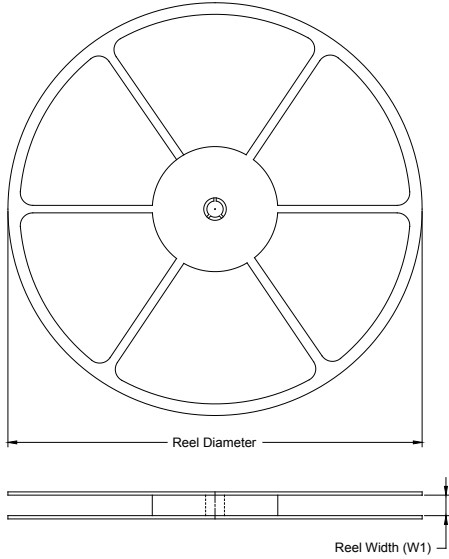

### TAPE DIMENSIONS

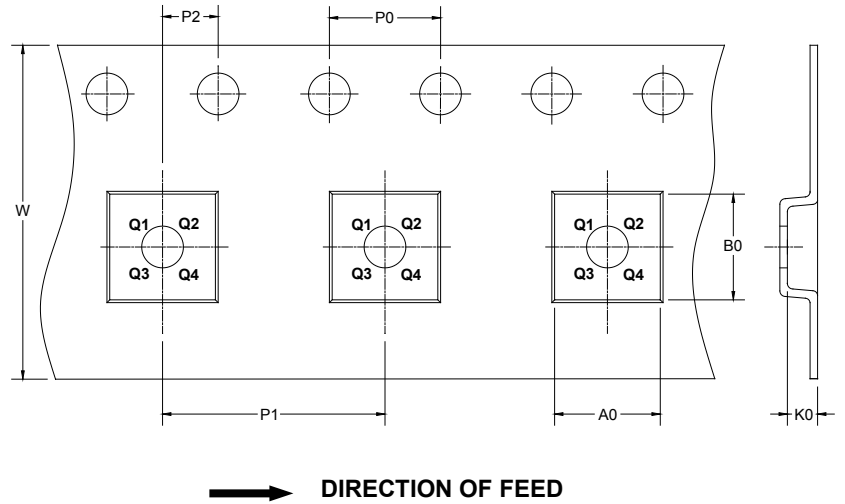

NOTE: The picture is only for reference. Please make the object as the standard.

### KEY PARAMETER LIST OF TAPE AND REEL

Package Type	Reel Diameter	Reel Width W1 (mm)	A0 (mm)	B0 (mm)	K0 (mm)	P0 (mm)	P1 (mm)	P2 (mm)	W (mm)	Pin1 Quadrant
SOT-23-5	7"	9.5	3.20	3.20	1.40	4.0	4.0	2.0	8.0	Q3

DD0001



# PACKAGE INFORMATION

## CARTON BOX DIMENSIONS



NOTE: The picture is only for reference. Please make the object as the standard.

## KEY PARAMETER LIST OF CARTON BOX

Reel Type	Length (mm)	Width (mm)	Height (mm)	Pizza/Carton
7" (Option)	368	227	224	8
7"	442	410	224	18

DD0002