

■ Features

- $V_{DS} (V) = 60V$
- $I_D = 3 A (V_{GS} = 10V)$
- $R_{DS(ON)} < 80m\Omega (V_{GS} = 10V), I_D=3A$
- $R_{DS(ON)} < 95m\Omega (V_{GS} = 4.5V), I_D=1.9A$

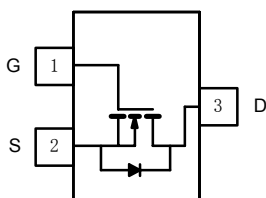
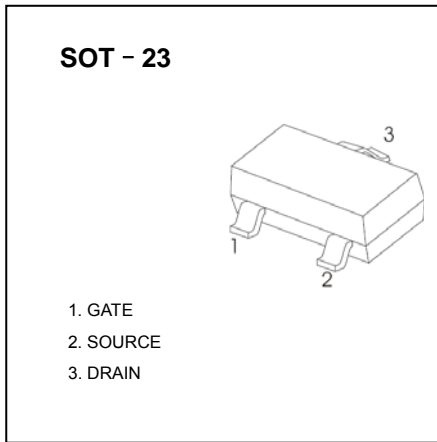

■ Absolute Maximum Ratings $T_a = 25^\circ C$

Parameter	Symbol	Rating	Unit	
Drain-Source Voltage	V_{DS}	60	V	
Gate-Source Voltage	V_{GS}	± 20		
Continuous Drain Current	I_D	$T_a=25^\circ C$	3	A
		$T_a=70^\circ C$	1.9	
Pulsed Drain Current	I_{DM}	10		
Power Dissipation	P_D	$T_a=25^\circ C$	1.25	W
		$T_a=70^\circ C$	0.8	
Thermal Resistance.Junction- to-Ambient	R_{thJA}	(Note.1)	100	$^\circ C/W$
		(Note.2)	166	
Junction Temperature	T_J	150	$^\circ C$	
Storage Temperature Range	T_{stg}	-55 to 150		

Note.1: Surface Mounted on FR4 Board, $t \leq 5 \text{ sec.}$

Note.2: Surface Mounted on FR4 Board

■ **Electrical Characteristics Ta = 25°C**

Parameter	Symbol	Test Conditions	Min	Typ	Max	Unit
Drain-Source Breakdown Voltage	V_{DS}	$I_D=250\ \mu A, V_{GS}=0V$	60			V
Zero Gate Voltage Drain Current	I_{DSS}	$V_{DS}=60V, V_{GS}=0V$			0.5	μA
		$V_{DS}=60V, V_{GS}=0V, T_J=55^\circ C$			10	
Gate-Body Leakage Current	I_{GSS}	$V_{DS}=0V, V_{GS}=\pm 20V$			± 100	nA
Gate Threshold Voltage	$V_{GS(th)}$	$V_{DS}=V_{GS}, I_D=250\ \mu A$	1		3	V
Static Drain-Source On-Resistance	$R_{DS(on)}$	$V_{GS}=10V, I_D=3A$			80	$m\ \Omega$
		$V_{GS}=4.5V, I_D=1.9A$			95	
On State Drain Current	$I_{D(on)}$	$V_{GS}\geq 4.5V, V_{DS}=10V$	6			A
		$V_{GS}\geq 4.5V, V_{DS}=4.5V$	4			
Forward Transconductance	g_{FS}	$V_{DS}=4.5V, I_D=2A$		4.6		S
Input Capacitance	C_{iss}	$V_{GS}=0V, V_{DS}=25V, f=1MHz$		240		pF
Output Capacitance	C_{oss}			50		
Reverse Transfer Capacitance	C_{rss}			15		
Gate Resistance	R_g	$V_{GS}=0V, V_{DS}=0V, f=1MHz$	0.5		3.3	Ω
Total Gate Charge	Q_g	$V_{GS}=10V, V_{DS}=30V, I_D=2A$		4.8	10	nC
Gate Source Charge	Q_{gs}			0.8		
Gate Drain Charge	Q_{gd}			1		
Turn-On DelayTime	$t_{d(on)}$	$V_{GS}=4.5V, V_{DS}=30V, I_D=1A, R_L=30\ \Omega, R_G=6\ \Omega$		7	15	ns
Turn-On Rise Time	t_r			10	20	
Turn-Off DelayTime	$t_{d(off)}$			17	35	
Turn-Off Fall Time	t_f			6	15	
Maximum Body-Diode Continuous Current	I_S				1	A
Diode Forward Voltage	V_{SD}	$I_S=1A, V_{GS}=0V$			1.2	V

Note. Pulse test; pulse width $\leq 300\ \mu s$, duty cycle $\leq 2\%$.

■ Typical Characteristics

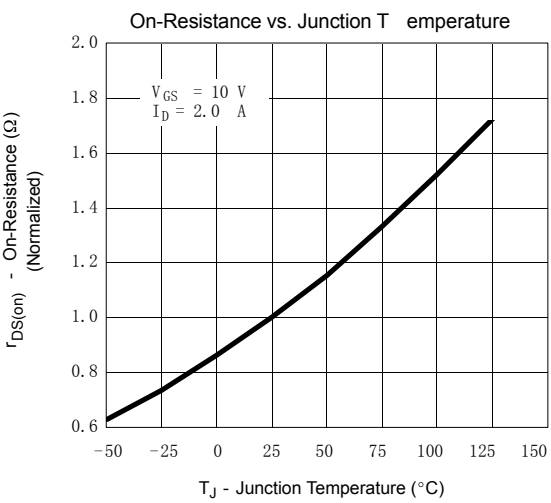
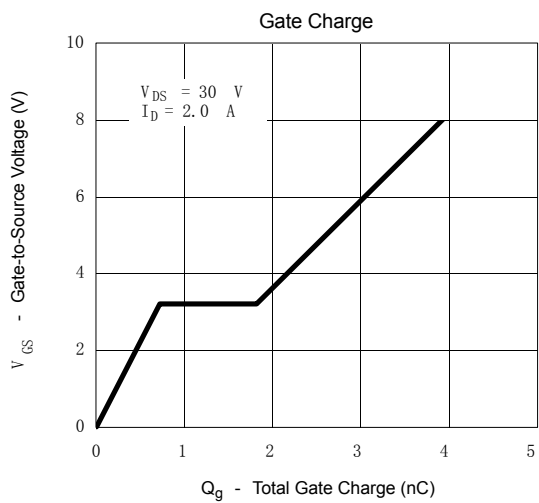
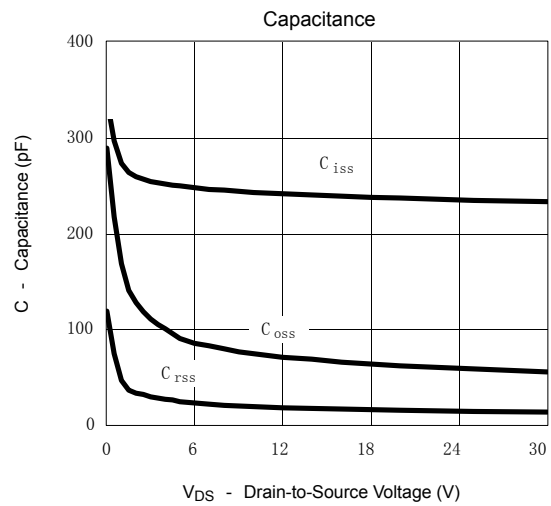
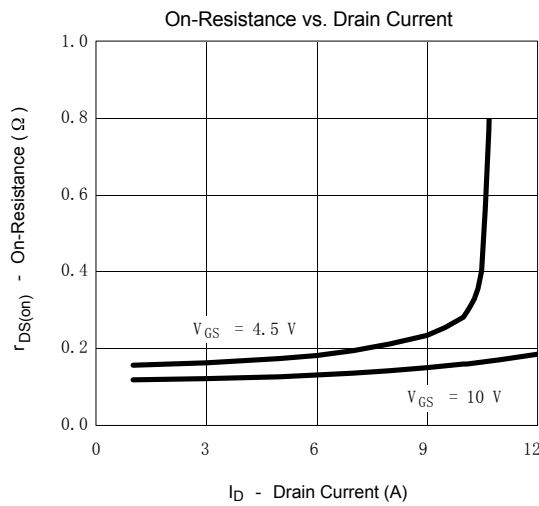
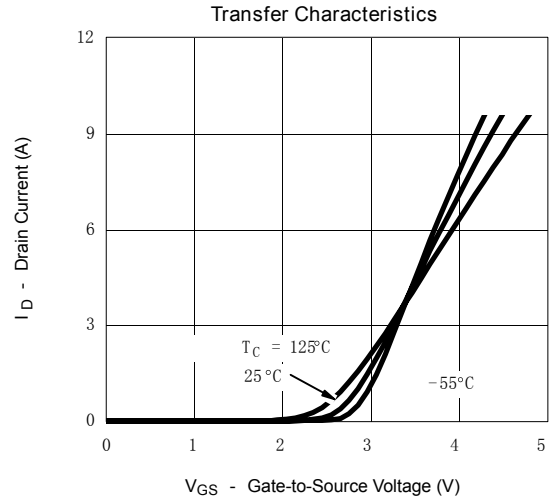
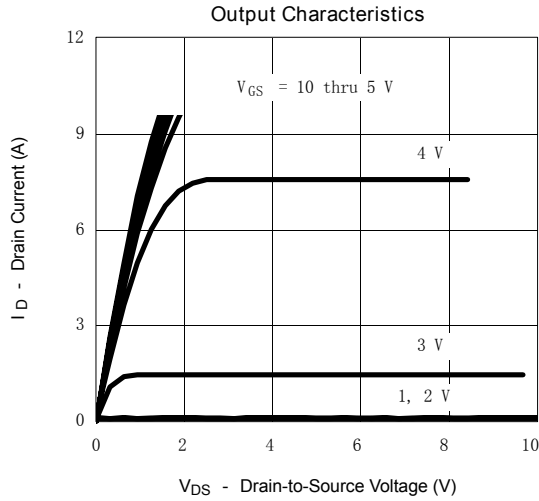

■ Typical Characteristics

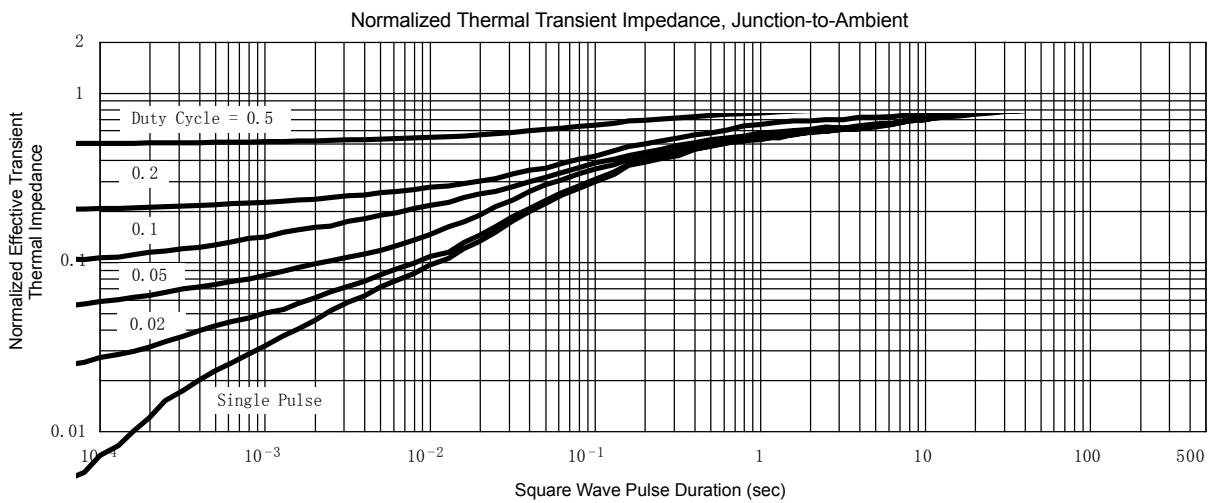
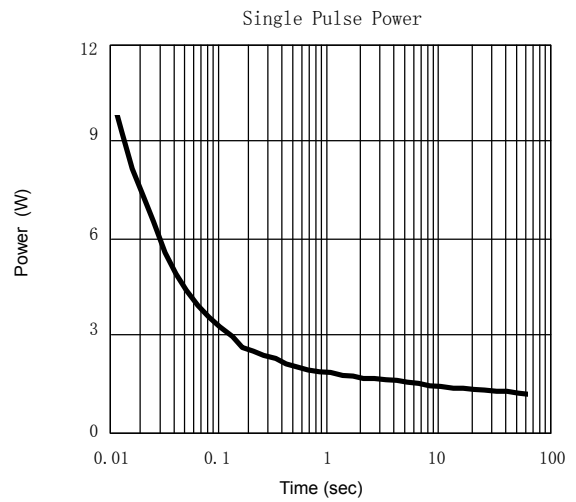
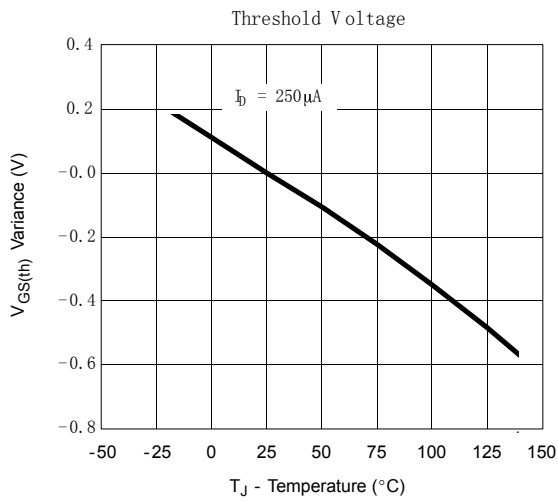
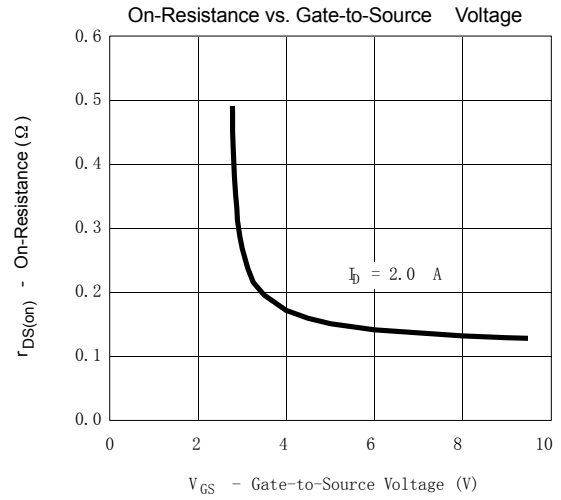
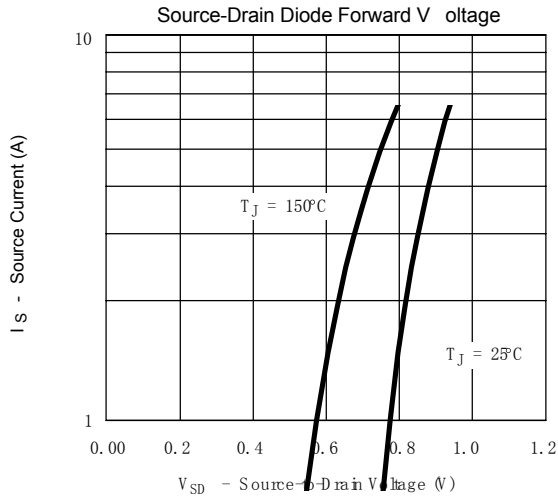

SOT-23 PACKAGE OUTLINE DIMENSIONS

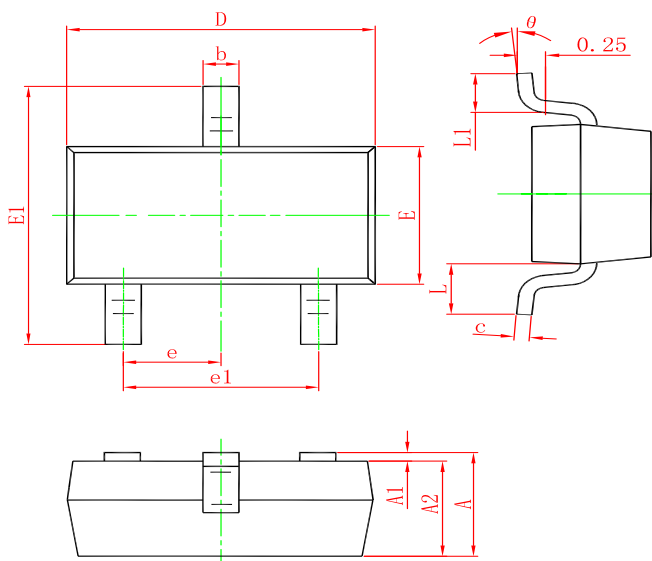

Symbol	Dimensions In Millimeters		Dimensions In Inches	
	Min.	Max.	Min.	Max.
A	0.900	1.150	0.035	0.045
A1	0.000	0.100	0.000	0.004
A2	0.900	1.050	0.035	0.041
b	0.300	0.500	0.012	0.020
c	0.080	0.150	0.003	0.006
D	2.800	3.000	0.110	0.118
E	1.200	1.400	0.047	0.055
E1	2.250	2.550	0.089	0.100
e	0.950 TYP.		0.037 TYP.	
e1	1.800	2.000	0.071	0.079
L	0.550 REF.		0.022 REF.	
L1	0.300	0.500	0.012	0.020
θ	0°	8°	0°	8°

Marking



Ordering information

Order code	Package	Baseqty	Deliverymode
UMW SI2308A	SOT-23	3000	Tape and reel