

10W isolated DC-DC converter with Ultra-wide Input and Regulated Single Output

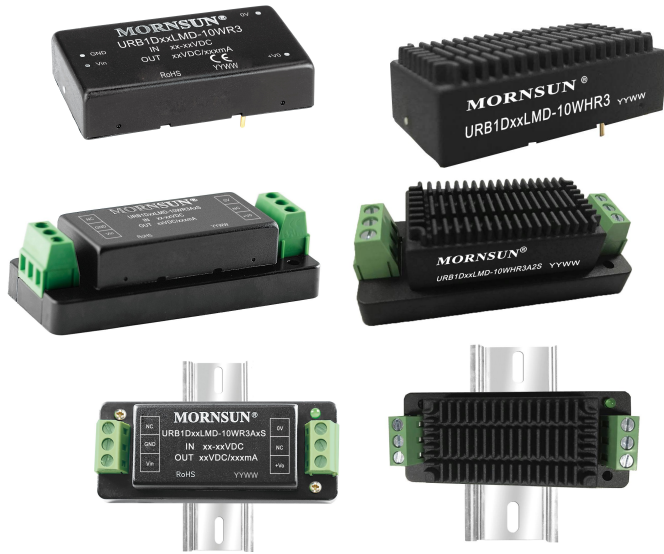

### FEATURES

- Ultra-wide 4:1 input voltage range
- High efficiency up to 85%
- Reinforced I/O isolation test voltage 2.25k VDC
- Operating ambient temperature range -40°C to +85°C
- Input under-voltage protection, output short circuit, over-current, over-voltage protection
- Low output ripple & noise
- EN50121-3-2 & CISPR32/EN55032 CLASS A EMI compliant without external components
- EN50155/EN60950 Approval
- Designed to meet UL62368/IEC62368 standard
- Input Reverse Polarity Protection available with Chassis (A2S) or DIN-Rail mounting (A4S) version
- Industry standard pin-out

URB1D\_LMD-10WR3 series of isolated 10W DC-DC converter products with an ultra-wide 4:1 input voltage and feature efficiencies of up to 85%. Input to output isolation is tested with 2250VDC and the converter safely operate ambient temperature of -40 °C to +85 °C, input under-voltage protection, output short-circuit, over-voltage, over-current protection and are offered with various mounting options ideally suiting electronic equipment and railway vehicle applications using 72V, 96V and 110V battery voltages.

### Selection Guide

Certification	Part No. ①	Input Voltage (VDC)		Output		Full Load Efficiency ③ (%) Min./Typ.	Max. Capacitive Load (μF)
		Nominal (Range)	Max. ②	Voltage (VDC)	Current (mA) Max./Min.		
CE	URB1D03LMD-10WR3	110 (40-160)	170	3.3	2400/0	74/76	5400
	URB1D05LMD-10WR3			5	2000/0	78/80	5400
	URB1D12LMD-10WR3			12	833/0	82/84	470
	URB1D15LMD-10WR3			15	667/0	82/84	330
	URB1D24LMD-10WR3			24	417/0	83/85	100

Note:  
 ① Use "H" suffix for heat sink mounting, "A2S" suffix for chassis mounting and "A4S" suffix for DIN-Rail mounting. We recommend to choose modules with a heat sink for enhanced heat dissipation and applications with extreme temperature requirements;  
 ② Absolute maximum stress rating without damage (not recommended);  
 ③ Efficiency is measured at nominal input voltage and rated output load; efficiencies for A2S and A4S Model's is decreased by 2% due to the input reverse polarity protection circuit.

### Input Specifications

Item	Operating Conditions	Min.	Typ.	Max.	Unit
Input Current (full load / no-load)	Nominal input voltage	3.3V output	95/3	98/8	mA
		Others	110/3	117/8	
Reflected Ripple Current	Nominal input voltage	--	25	--	VDC
Surge Voltage (1sec. max.)		-0.7	--	180	
Start-up Voltage	100% load	--	--	40	
Shut-down Voltage		28	33	--	ms
Start-up Time	Nominal input voltage & constant resistance load	--	10	--	
Input Filter		Pi filter			
Hot Plug		Unavailable			

### Output Specifications

Item	Operating Conditions	Min.	Typ.	Max.	Unit	
Voltage Accuracy	0%-100% load	--	±1	±3	%	
Linear Regulation	Input voltage variation from low to high at full load	--	±0.2	±0.5		
Load Regulation	0%-100% load	--	±0.5	±1	%	
Transient Recovery Time		--	300	500	μs	
Transient Response Deviation	25% load step change, nominal input voltage	3.3V/5V output	--	±3	±8	%
		Others	--	±3	±5	
Temperature Coefficient	Full load	--	±0.02	±0.03	%/°C	
Ripple & Noise <sup>①</sup>	20MHz bandwidth, 5%-100% load	--	50	100	mV p-p	
Over-voltage Protection	Input voltage range	110	--	160	%Vo	
Over-current Protection		120	--	210	%Io	
Short-circuit Protection		Continuous, self-recovery				

Note: ①Ripple & Noise at <5% load is 5%Vo max. The "parallel cable" method is used for Ripple and Noise test, please refer to DC-DC Converter Application Notes for specific information.

### General Specifications

Item	Operating Conditions	Min.	Typ.	Max.	Unit
Isolation	Input-output Electric Strength Test for 1 minute with a leakage current of 1mA max.	2250	--	--	VDC
	Input/output-case Electric Strength Test for 1 minute with a leakage current of 1mA max.	1600	--	--	
Insulation Resistance	Input-output resistance at 500VDC	1000	--	--	MΩ
Isolation Capacitance	Input-output capacitance at 100KHz/0.1V	--	2200	--	pF
Operating Temperature	See Fig.1	-40	--	+85	°C
Storage Temperature		-55	--	+125	
Pin Soldering Resistance Temperature	Soldering spot is 1.5mm away from case for 10 seconds	--	--	300	
Storage Humidity	Non-condensing	5	--	95	%RH
Vibration		IEC61373 - Category 1, Grade B			
Switching Frequency <sup>①</sup>	PWM Mode	--	300	--	KHz
MTBF	MIL-HDBK-217F@25°C	1000	--	--	K hours

Note:① Switching frequency is measured at full load. The module reduces the switching frequency for light load (below 50%) efficiency improvement.

### Mechanical Specifications

Case Material	Aluminum alloy				
Dimensions	Horizontal package (without heat sink)			50.80 x 25.40 x 11.80 mm	
	Horizontal package (with heat sink)			51.40 x 26.20 x 16.50 mm	
	A2S chassis mounting (without heat sink)			76.00 x 31.50 x 21.20 mm	
	A2S chassis mounting (with heat sink)			76.00 x 31.50 x 25.30 mm	
	A4S Din-rail mounting (without heat sink)			76.00 x 31.50 x 25.80 mm	
	A4S Din-rail mounting (with heat sink)			76.00 x 31.50 x 29.90 mm	
Weight	without heat sink	Horizontal package/A2S chassis mounting/A4S Din-rail mounting		26.0g/48.0g/68.0g(Typ.)	
	with heat sink	Horizontal package/A2S chassis mounting/A4S Din-rail mounting		34.0g/56.0g/76.0g(Typ.)	
Cooling Methods	Free air convection				

Electromagnetic compatibility (EMC) (EN60950)

Emissions	CE	CISPR32/EN55032	CLASS A (without external components)/ CLASS B (see Fig.3 or Fig.4 for recommended circuit)	
	RE	CISPR32/EN55032	CLASS A (without external components)/ CLASS B (see Fig.3 or Fig.4 for recommended circuit)	
Immunity	ESD	IEC/EN61000-4-2	Contact ±6KV/Air ±8KV	perf. Criteria B
	RS	IEC/EN61000-4-3	20V/m	perf. Criteria A
	EFT	IEC/EN61000-4-4	±4KV (see Fig.3 or Fig.4 for recommended circuit)	perf. Criteria B
	Surge	IEC/EN61000-4-5	line to line ±2KV (2Ω 18uF see Fig.3 for recommended circuit) line to ground ±4KV (12Ω 9uF see Fig.3 for recommended circuit)	perf. Criteria B
	CS	IEC/EN61000-4-6	10 Vr.m.s	perf. Criteria A

Electromagnetic Compatibility (EMC) (EN50155)

Emissions	CE	EN50121-3-2	150kHz-500kHz 99dBuV	
	RE	EN50121-3-2	30MHz-230MHz 40dBuV/m at 10m	
Immunity	ESD	EN50121-3-2	Contact ±6KV/Air ±8KV	perf. Criteria B
	RS	EN50121-3-2	20V/m	perf. Criteria A
	EFT	EN50121-3-2	±2kV 5/50ns 5kHz	perf. Criteria A
	Surge	EN50121-3-2	line to line ±1KV (42Ω, 0.5 μ F) line to ground ±2KV (42Ω, 0.5 μ F)	perf. Criteria B
	CS	EN50121-3-2	0.15MHz-80MHz 10V r.m.s	perf. Criteria A

Note: All the tests are measured under the conditions of inputs capacitor 100uF/200V or FC-CX1D.

Typical Characteristic Curves

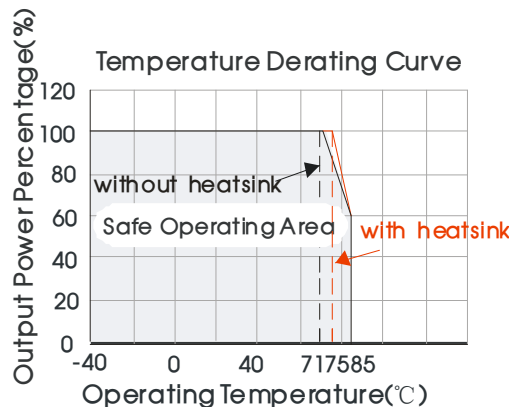
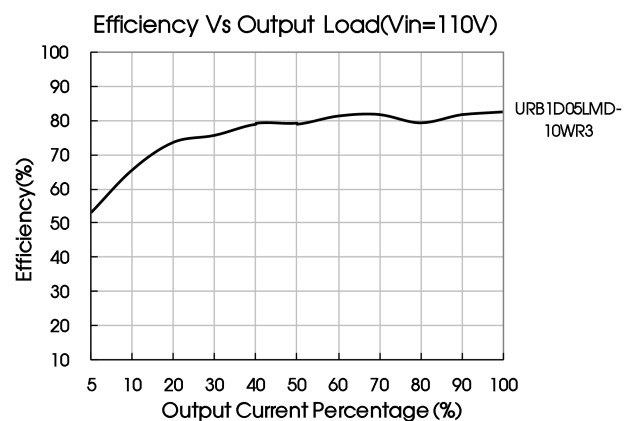
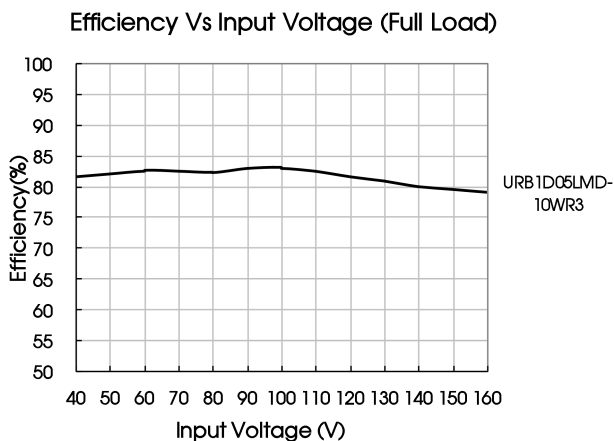
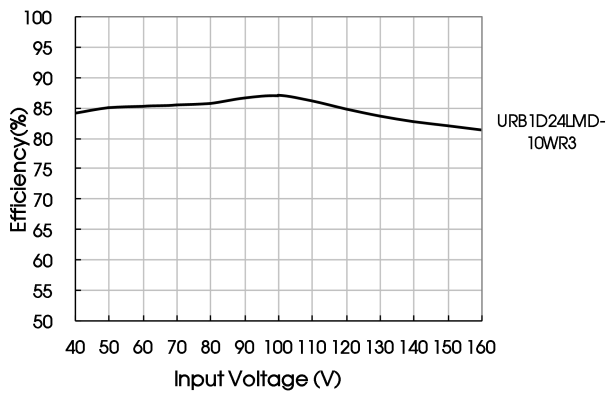

Fig. 1



Efficiency Vs Input Voltage (Full Load)



Efficiency Vs Output Load (Vin=110V)

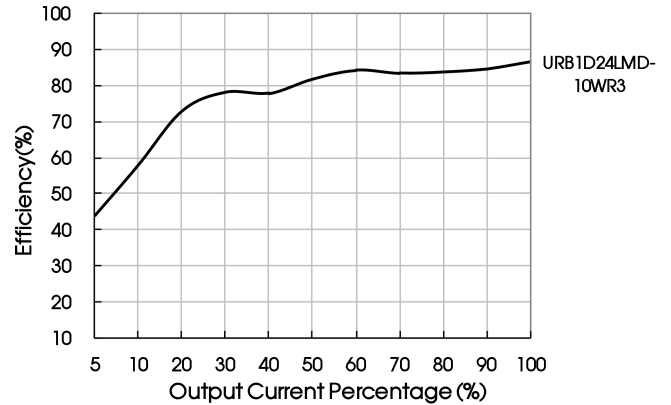

## Design Reference

### 1. Typical application

All the DC-DC converters of this series are tested before delivery using the recommended circuit shown in Fig. 2. Input and/or output ripple can be further reduced by appropriately increasing the input & output capacitor values  $C_{in}$  and  $C_{out}$  and/or by selecting capacitors with a low ESR (equivalent series resistance). Also make sure that the capacitance is not exceeding the max. capacitive load value of the product.

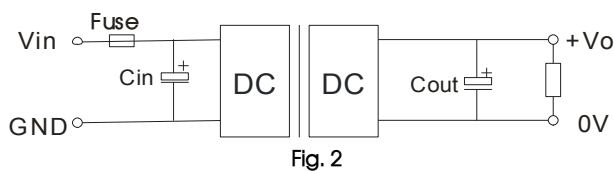

Vout(VDC)	Fuse	Cin	Cout
3.3/5	2A, slow blow	10 $\mu$ F - 47 $\mu$ F	100 $\mu$ F
12/15			47 $\mu$ F
24			22 $\mu$ F

### 2. EMC compliance circuit

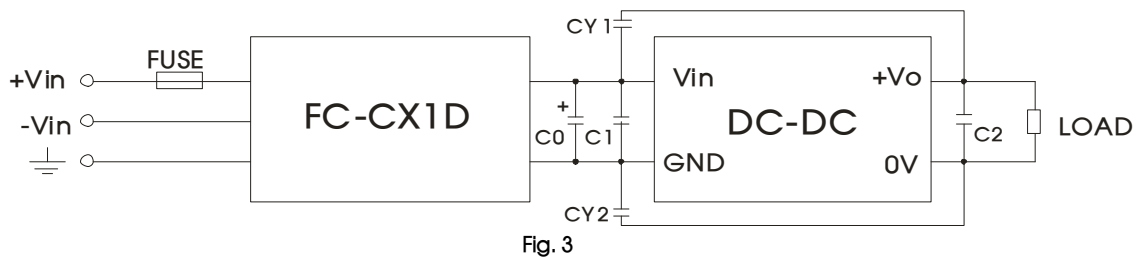

Fig. 3 List of components:

FUSE	Choose according to actual input current
FC-CX1D	FC-CX1D is the EMC auxiliary component of our company. Input voltage range: 40V-160V
C0	100 $\mu$ F/200V
C1	Refer to the $C_{in}$ in Fig.2
C2	Refer to the $C_{out}$ in Fig.2
CY1, CY2	1000pF/400VAC

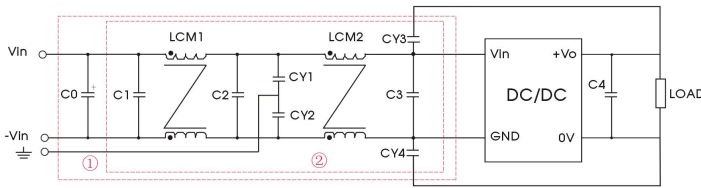

Fig. 4

Notes: Part ① in the Fig. 4 is used for EMC test and part ② for EMI test

Fig. 4 List of components:

C0	100 $\mu$ F/200V
C1、C2	0.22 $\mu$ F/250V
C3	Refer to the Cin in Fig.2
LCM1	2.2mH(FL2D-10-222)
LCM2	1.1mH (material:TN150P-RH12.7*12.7*7.9)
CY1、CY2、CY3、CY4	1000pF/400VAC
C4	Refer to the Cout in Fig.2

Notes: FL2D-10-222 is the EMC auxiliary component of our company.

- The products do not support parallel connection of their output
- For additional information about Mornsun EMC Filter products please refer to [www.mornsun-power.com](http://www.mornsun-power.com) to download the Selection Guide of EMC Filter

### Horizontal Package (without heat sink) Dimensions and Recommended Layout

THIRD ANGLE PROJECTION

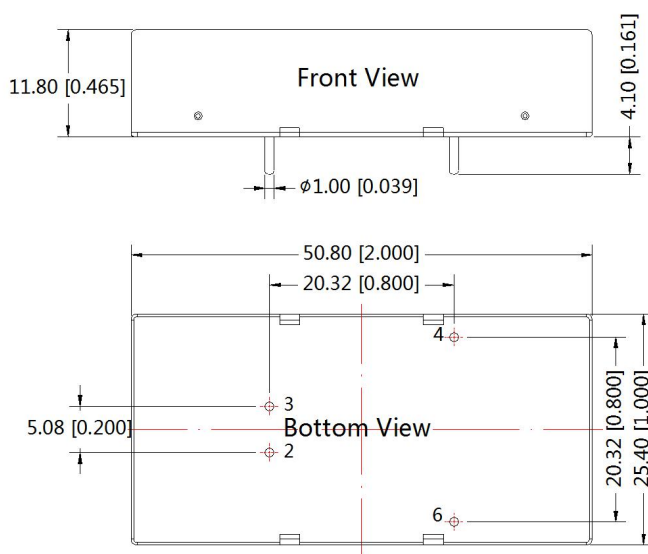

Note:  
Unit: mm[inch]  
Pin diameter tolerances:  $\pm 0.10[\pm 0.004]$   
General tolerances:  $\pm 0.50[\pm 0.020]$

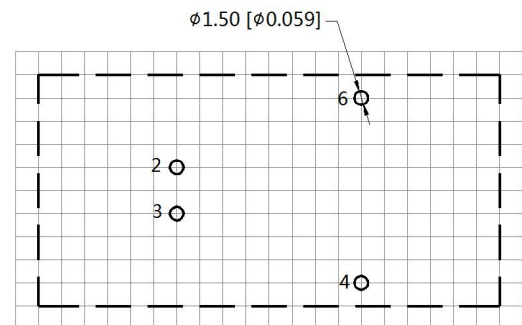

Note : Grid 2.54\*2.54mm

Pin-Out	
Pin	Function
2	GND
3	Vin
4	+Vo
6	0V

Horizontal Package (with heat sink) Dimensions

THIRD ANGLE PROJECTION 

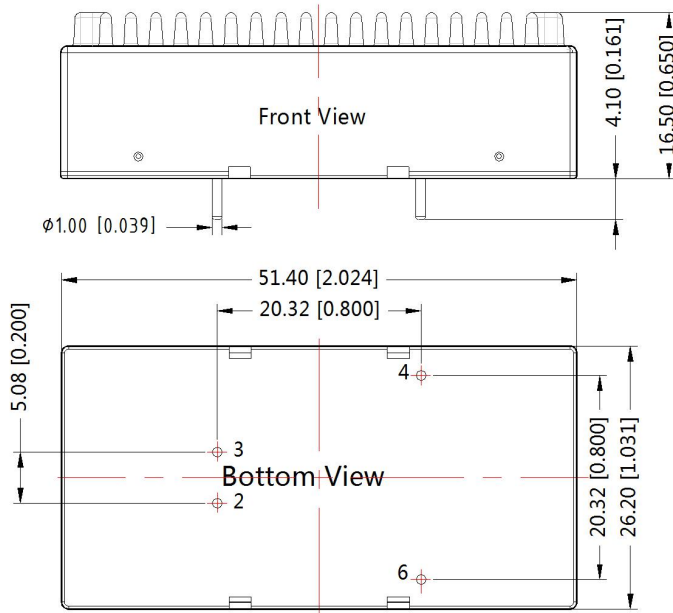

Pin-Out	
Pin	Function
2	GND
3	Vin
4	+Vo
6	0V

Note:  
Unit :mm[inch]  
General tolerances:±0.50[±0.020]

URB\_LMD-10WR3A2S (without heat sink) Dimensions

THIRD ANGLE PROJECTION 

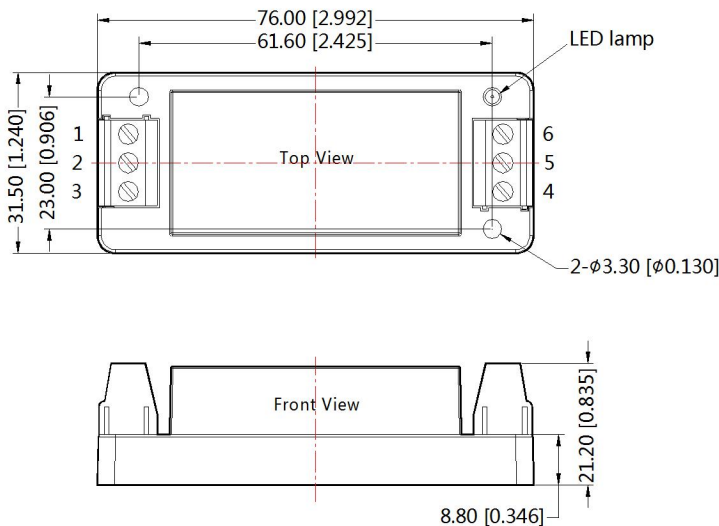

Pin-Out						
Pin	1	2	3	4	5	6
Function	NC	GND	Vin	+Vo	NC	0V

Note:  
Unit: mm[inch]  
Wire range: 24-12 AWG  
Tightening torque: Max 0.4 N·m  
General tolerances: ±0.50[±0.020]



URB\_LMD-10WHR3A2S (with heat sink) Dimensions

THIRD ANGLE PROJECTION 

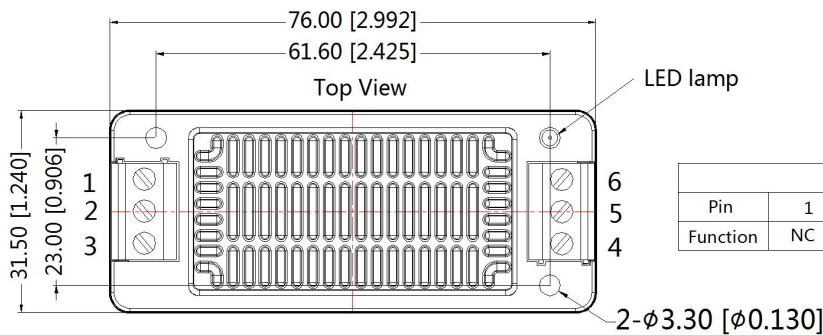

Pin-Out						
Pin	1	2	3	4	5	6
Function	NC	GND	Vin	+Vo	NC	0V

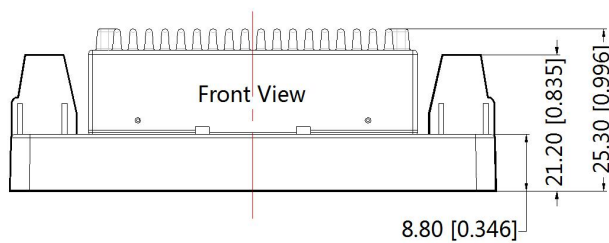

Note:  
Unit: mm[inch]  
Wire range: 24-12 AWG  
Tightening torque: Max 0.4 N·m  
General tolerances: ±0.50[±0.020]

URB\_LMD-10WR3A4S (without heat sink) Dimensions

THIRD ANGLE PROJECTION 

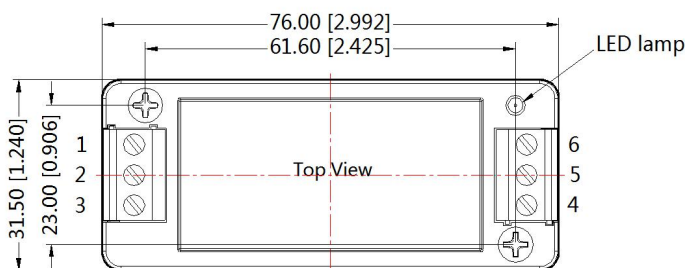

Pin-Out						
Pin	1	2	3	4	5	6
Function	NC	GND	Vin	+Vo	NC	0V

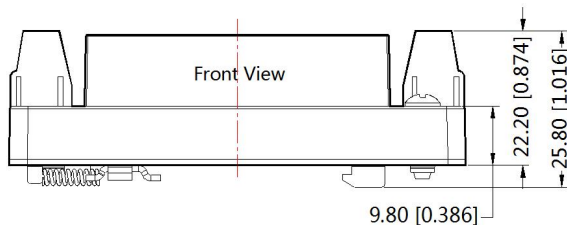

Note:  
Unit: mm[inch]  
Mounting rail: TS35  
Wire range: 24-12 AWG  
Tightening torque: Max 0.4 N·m  
General tolerances: ±1.00[±0.039]

URB\_LMD-10WHR3A4S(with heat sink) Dimensions

THIRD ANGLE PROJECTION 

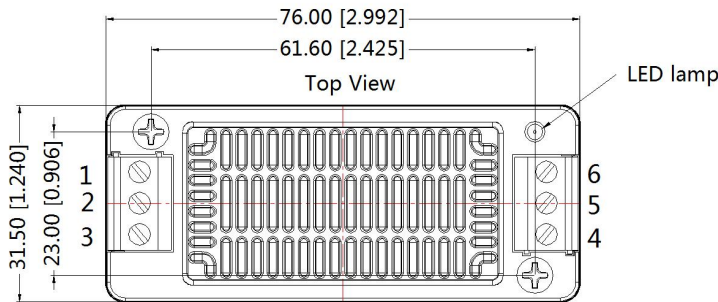

Pin-Out						
Pin	1	2	3	4	5	6
Function	NC	GND	Vin	+Vo	NC	0V

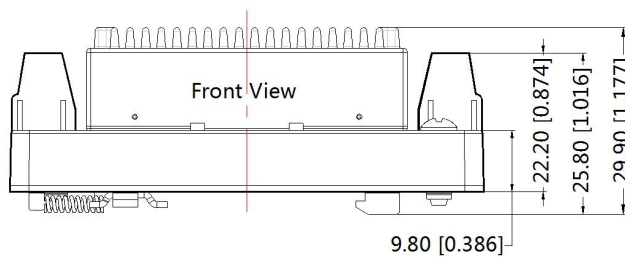

Note:  
Unit: mm[inch]  
Mounting rail: TS35  
Wire range: 24-12 AWG  
Tightening torque: Max 0.4 N·m  
General tolerances:  $\pm 1.00[\pm 0.039]$

Note:

1. For additional information on Product Packaging please refer to [www.mornsun-power.com](http://www.mornsun-power.com). The Packaging bag number of Horizontal packaging: 58200035(without heat sink), 58200051(with heat sink), A2S/ A4S packaging number: 58220022;
2. The maximum capacitive load offered were tested at input voltage range and full load;
3. Unless otherwise specified, parameters in this datasheet were measured under the conditions of  $T_a=25^{\circ}\text{C}$ , humidity<75%RH with nominal input voltage and rated output load;
4. All index testing methods in this datasheet are based on Company's corporate standards;
5. Other product application information, please see DC-DC (railway power supply) Converter Application Notes for specific operation methods;
6. We can provide product customization service, please contact our technicians directly for specific information;
7. Products are related to laws and regulations: see "Features" and "EMC";
8. Our products shall be classified according to ISO14001 and related environmental laws and regulations, and shall be handled by qualified units.

Mornsun Guangzhou Science & Technology Co., Ltd.

Address: No. 5, Kehui St. 1, Kehui Development Center, Science Ave., Guangzhou Science City, Luogang District, Guangzhou, P. R. China  
Tel: 86-20-38601850 Fax: 86-20-38601272 E-mail: sales@mornsun.cn www.mornsun-power.com