

30V N-Channel Enhancement Mode Power MOSFET

Description

WMB040N03LG2 uses Wayon's 2nd generation power trench MOSFET technology that has been especially tailored to minimize the on-state resistance and yet maintain superior switching performance. This device is well suited for high efficiency fast switching applications.

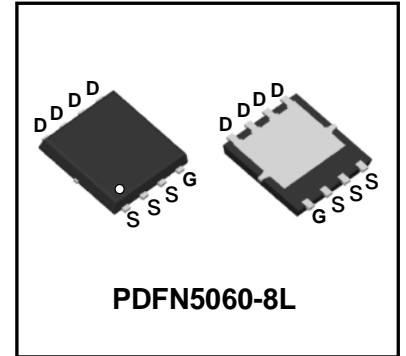

Features

- $V_{DS} = 30V$, $I_D = 58A$
 $R_{DS(on)} < 4.0m\Omega @ V_{GS} = 10V$
 $R_{DS(on)} < 6.2m\Omega @ V_{GS} = 4.5V$
- Low $R_{DS(on)}$
- Low Gate Charge
- 100% EAS Guaranteed
- RoHS and Halogen-Free Compliant

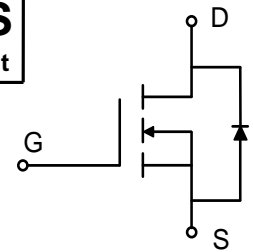

Applications

- Power Management in Switches
- DC/DC Converter

Absolute Maximum Ratings

Parameter		Symbol	Value	Unit
Drain-Source Voltage		V_{DS}	30	V
Gate-Source Voltage		V_{GS}	± 20	V
Continuous Drain Current ¹	$T_C=25^\circ C$	I_D	58	A
	$T_C=100^\circ C$		38	
Pulsed Drain Current ²		I_{DM}	118	A
Single Pulse Avalanche Energy ³		EAS	88	mJ
Avalanche Current		I_{AS}	42	A
Total Power Dissipation ⁴	$T_C=25^\circ C$	P_D	28	W
Operating Junction and Storage Temperature Range		T_J, T_{STG}	-55 to 150	$^\circ C$

Thermal Characteristics

Parameter	Symbol	Value	Unit
Thermal Resistance from Junction-to-Ambient ¹	$R_{\theta JA}$	51	$^\circ C/W$
Thermal Resistance from Junction-to-Case ¹	$R_{\theta JC}$	4.5	$^\circ C/W$

Electrical Characteristics $T_c = 25^\circ\text{C}$, unless otherwise noted

Parameter	Symbol	Test Conditions	Min.	Typ.	Max.	Unit	
Static Characteristics							
Drain-Source Breakdown Voltage	$V_{(BR)DSS}$	$V_{GS} = 0V, I_D = 250\mu A$	30	-	-	V	
Gate-body Leakage Current	I_{GSS}	$V_{DS} = 0V, V_{GS} = \pm 20V$	-	-	± 100	nA	
Zero Gate Voltage Drain Current	$T_J=25^\circ\text{C}$	I_{DSS}	$V_{DS} = 30V, V_{GS} = 0V$	-	-	1	μA
	$T_J=55^\circ\text{C}$			-	-	5	
Gate-Threshold Voltage	$V_{GS(th)}$	$V_{DS} = V_{GS}, I_D = 250\mu A$	1.2	-	2.2	V	
Drain-Source On-Resistance ²	$R_{DS(on)}$	$V_{GS} = 10V, I_D = 20A$	-	3.6	4.0	m Ω	
		$V_{GS} = 4.5V, I_D = 15A$	-	5.0	6.2		
Forward Transconductance ²	g_{fs}	$V_{DS} = 5V, I_D = 20A$	-	76	-	S	
Dynamic Characteristics							
Input Capacitance	C_{iss}	$V_{DS} = 15V, V_{GS} = 0V, f = 1\text{MHz}$	-	1390	-	μF	
Output Capacitance	C_{oss}		-	680	-		
Reverse Transfer Capacitance	C_{rss}		-	53	-		
Switching Characteristics							
Gate Resistance	R_G	$V_{DS} = 0V, V_{GS} = 0V, f = 1\text{MHz}$	-	2	-	Ω	
Total Gate Charge	Q_g	$V_{GS} = 4.5V, V_{DS} = 15V, I_D = 20A$	-	15	-	nC	
Gate-Source Charge	Q_{gs}		-	5.9	-		
Gate-Drain Charge	Q_{gd}		-	3.5	-		
Turn-on Delay Time	$t_{d(on)}$	$V_{GS} = 10V, V_{DS} = 15V, R_G = 3\Omega, I_D = 20A$	-	7.7	-	nS	
Rise Time	t_r		-	20.5	-		
Turn-off Delay Time	$t_{d(off)}$		-	21.8	-		
Fall Time	t_f		-	4.5	-		
Drain-Source Body Diode Characteristics							
Diode Forward Voltage ²	V_{SD}	$I_S = 1A, V_{GS} = 0V$	-	-	1.0	V	
Continuous Source Current ^{1,5}	I_S	$V_G = V_D = 0V$, Force Current	-	-	58	A	

Notes:

- The data tested by surface mounted on a 1 inch² FR-4 board with 2OZ copper.
- The data tested by pulsed, pulse width $\leq 300\mu s$, duty cycle $\leq 2\%$
- The EAS data shows Max. rating. The test condition is $V_{DD}=25V, V_{GS}=10V, L=0.1mH, I_{AS}=42A$
- The power dissipation is limited by 150°C junction temperature
- The data is theoretically the same as I_D and I_{DM} , in real applications, should be limited by total power dissipation.

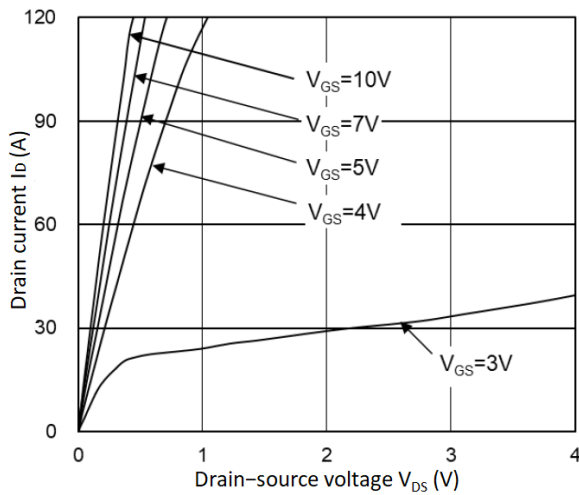

Figure 1. Output Characteristics

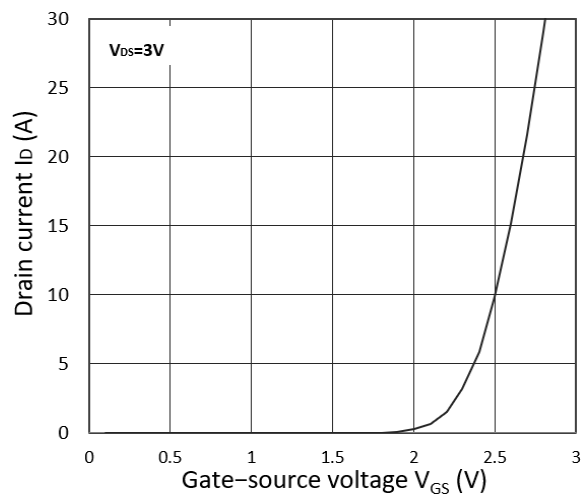

Figure 2. Transfer Characteristics

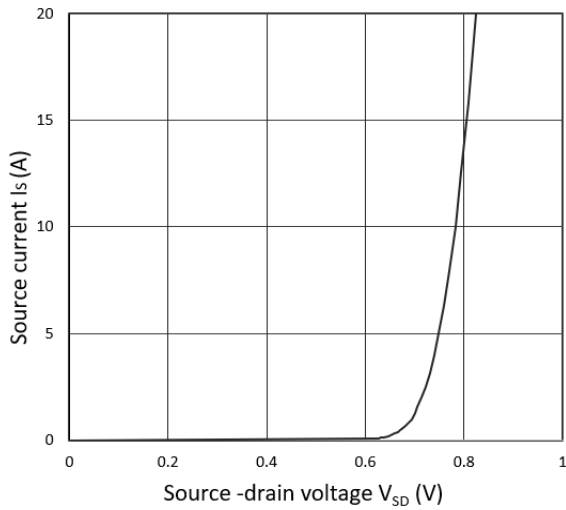

Figure 3. Forward Characteristics of Reverse

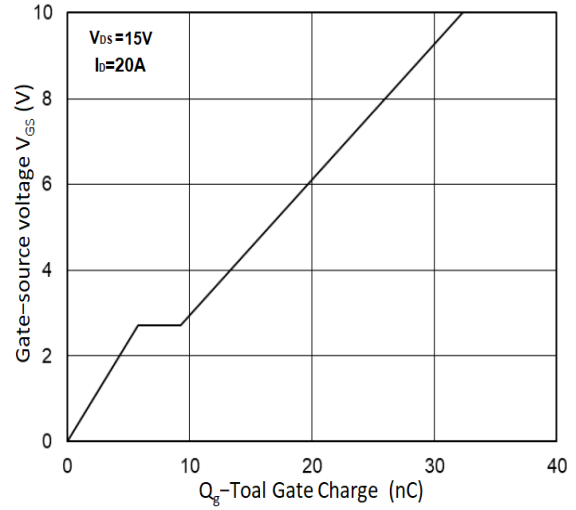

Figure 4. Gate Charge Characteristics

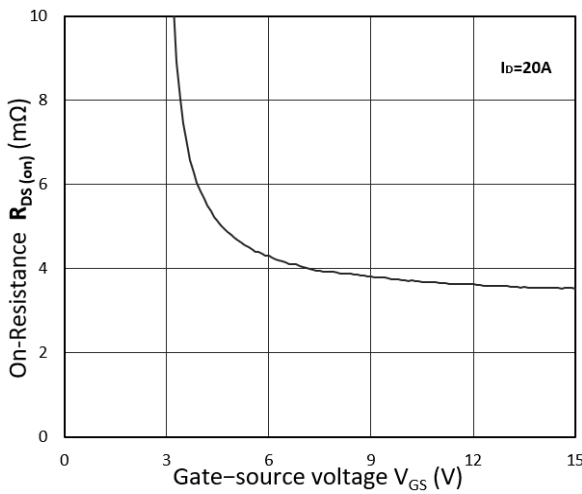

Figure 5. $R_{DS(on)}$ vs. V_{GS}

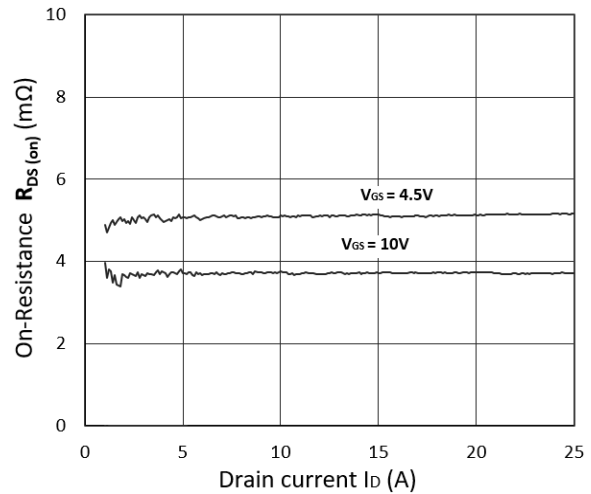

Figure 6. $R_{DS(on)}$ vs. I_D

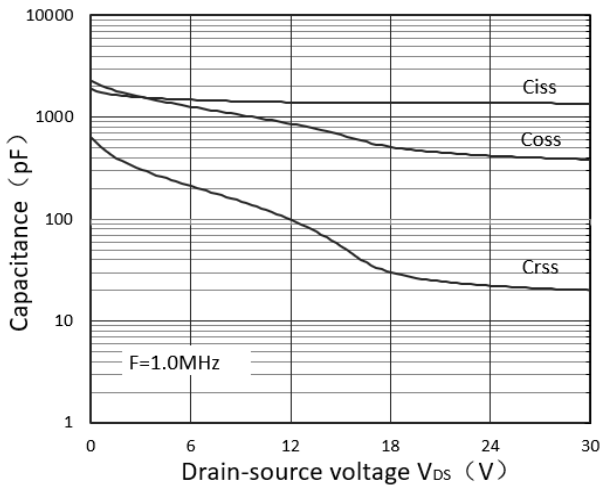

Figure 7. Capacitance Characteristics

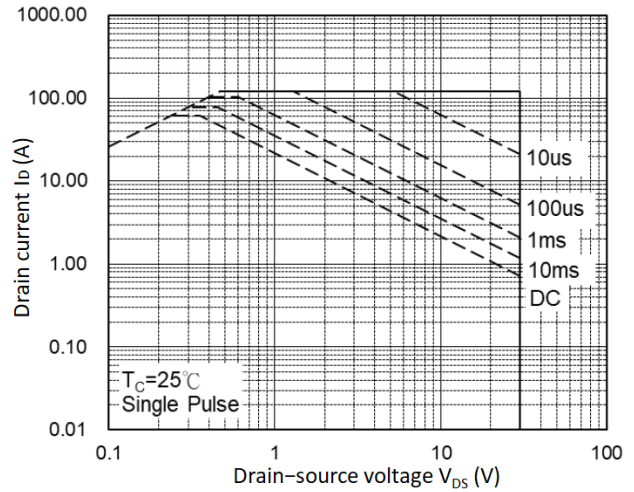

Figure 8. Safe Operating Area

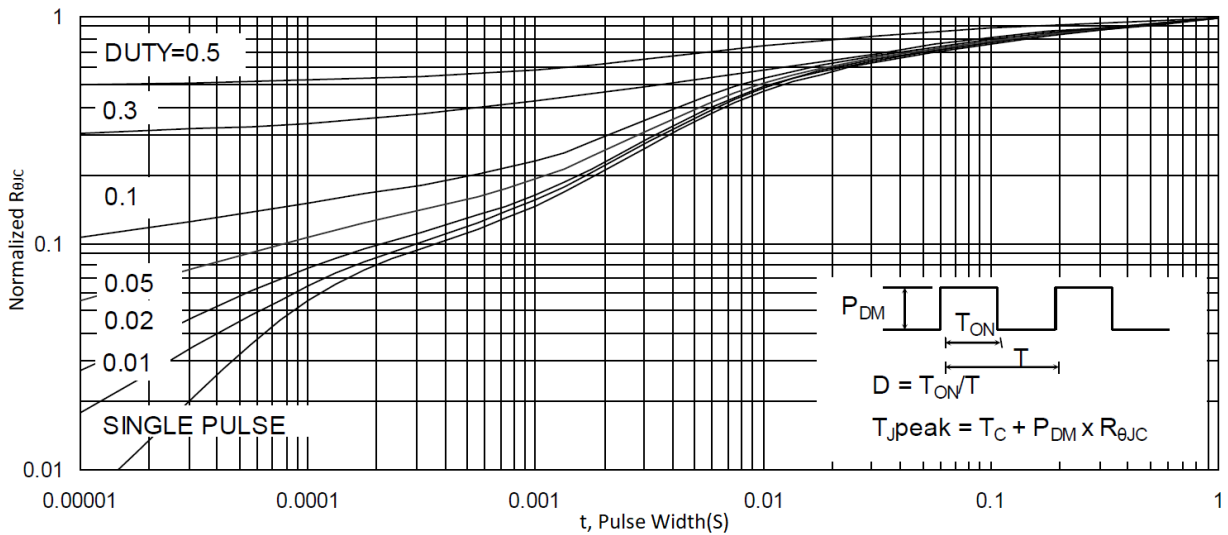

Figure 9. Normalized Maximum Transient Thermal Impedance

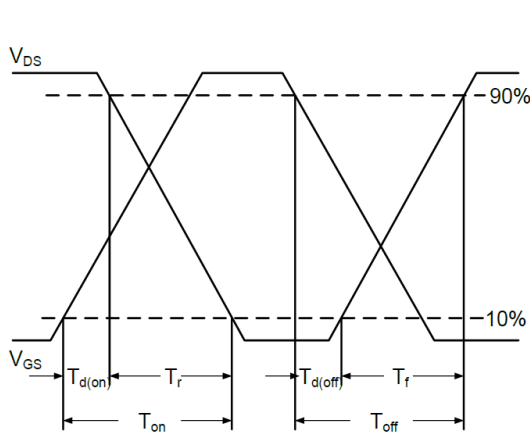

Figure 10. Switching Time Waveform

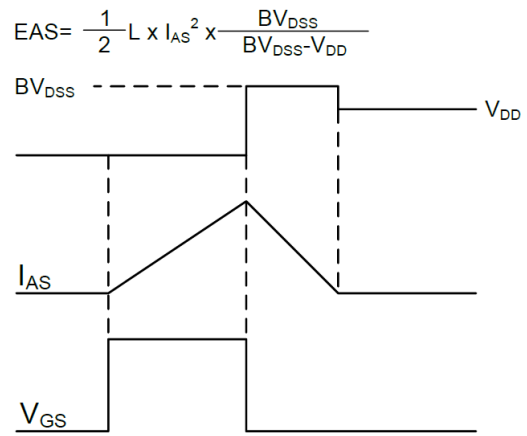
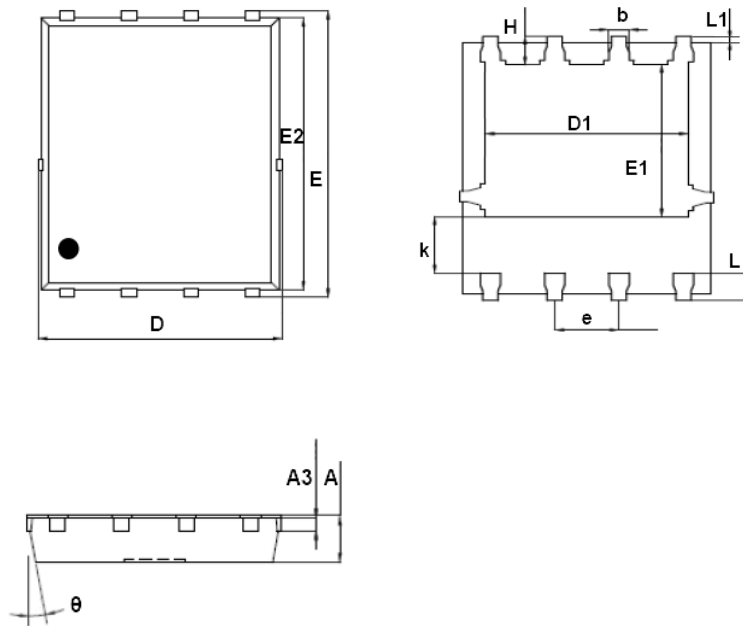

Figure 11. Unclamped Inductive Switching Waveform

Mechanical Dimensions for PDFN5060-8L

COMMON DIMENSIONS



SYMBOL	MM	
	MIN	MAX
A	0.90	1.20
A3	0.15	0.35
D	4.80	5.40
E	5.90	6.35
D1	3.61	4.31
E1	3.30	3.92
E2	5.65	6.06
k	1.10	-
b	0.30	0.51
e	1.27BSC	
L	0.38	0.71
L1	0.05	0.36
H	0.38	0.61
θ	0°	12°

Ordering Information

Part	Package	Marking	Packing method
WMB040N03LG2	PDFN5060-8L	B040N03L	Tape and Reel

Marking Information

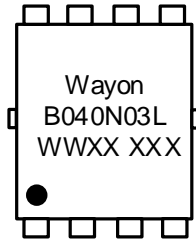

B040N03L = Device code

WWXX XXX= Date code

Contact Information

No.1001, Shiwan(7) Road, Pudong District, Shanghai, P.R.China.201207

Tel: 86-21-50310888 Fax: 86-21-50757680 Email: market@way-on.com

WAYON website: <http://www.way-on.com>

For additional information, please contact your local Sales Representative.

 is registered trademarks of Wayon Corporation.

Disclaimer

WAYON reserves the right to make changes without further notice to any Products herein to improve reliability, function, or design. The Products are not designed for use in hostile environments, including, without limitation, aircraft, nuclear power generation, medical appliances, and devices or systems in which malfunction of any Product can reasonably be expected to result in a personal injury. The information given in this document shall in no event be regarded as a guarantee of conditions or characteristics. WAYON does not assume any liability for infringement of patents, copyrights, or other intellectual property rights of third parties by or arising from the use of Products or technical information described in this document.