

mm inch

FEATURES

- **Silent**
Noise has been reduced by approximately 20 dB, using our own silencing design.
- **Less space required**
Measuring only 17(L)×13(W)mm (.669(L)×.512(W) inches), this product ranks first among automotive quiet relays in terms of saving space.
- **Sealed construction**

- **Next-generation standard terminal pitch employed**

The terminal array used is identical to that used in JJM relays.

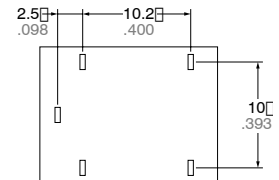

SPECIFICATIONS

Contact

Arrangement	1 Form C		
Contact material	AgSnO ₂ type		
Initial contact resistance (By voltage drop 6 V DC 1A)	Max. 100 mΩ		
Contact voltage drop	Max. 0.2V (at 10 A)		
Rating	Nominal switching capacity	N.O.: 20 A 14 V DC N.C.: 10 A 14 V DC	
	Max. carrying current	35 A for 2 minutes, 25 A for 1 hour (12 V, at 20°C 68°F) 30 A for 2 minutes, 20 A for 1 hour (12 V, at 85°C 185°F)	
	Min. switching capacity ^{#1}	1 A 12 V DC	
Expected life (min. operations)	Mechanical (at 120 cpm)	Min. 10 ⁷	
	Electrical	Resistive load	Min. 10 ^{5*}
		Motor load	Min. 3×10 ^{5**}

Coil

Nominal operating power	640 mW
-------------------------	--------

^{#1} This value can change due to the switching frequency, environmental conditions, and desired reliability level, therefore it is recommended to check this with the actual load.

Remarks

- *¹ At nominal switching capacity, operating frequency: 1s ON, 9s OFF
- *² N.O.: at 5 A (steady), 30 A (inrush)/N.C.: at 20 A (brake) 14 V DC, operating frequency: 1s ON, 2s OFF
- *³ Measurement at same location as "Initial breakdown voltage" section
- *⁴ Detection current: 10mA
- *⁵ Excluding contact bounce time
- *⁶ Half-wave pulse of sine wave: 11ms; detection: 10μs
- *⁷ Half-wave pulse of sine wave: 6ms
- *⁸ Detection time: 10μs

Characteristics

Max. operating speed (at nominal switching capacity)	6 cpm	
Initial insulation resistance ^{*3}	Min. 100 MΩ (at 500 V DC)	
Initial breakdown voltage ^{*4}	Between open contacts	500 Vrms for 1 min.
	Between contacts and coil	500 Vrms for 1 min.
Operate time ^{*5} (at nominal voltage)(at 20°C/68°F)	Max. 10 ms (initial)	
Release time ^{*5} (at nominal voltage)(at 20°C/68°F)	Max. 10 ms (initial)	
Shock resistance	Functional ^{*6}	Min. 100 m/s ² {10G}
	Destructive ^{*7}	Min. 1,000 m/s ² {100G}
Vibration resistance	Functional ^{*8}	10 Hz to 100 Hz, Min. 44.1 m/s ² {4.5G}
	Destructive ^{*9}	10 Hz to 500 Hz, Min. 44.1 m/s ² {4.5G}
Conditions for operation, transport and storage ^{*10} (Not freezing and condensing at low temperature)	Ambient temperature	-40°C to +85°C -40°F to +185°F
	Humidity	5% R.H. to 85% R.H.
Mass	Approx. 6.5g .23 oz	

^{*9} Time of vibration for each direction;
X, Y, direction: 2 hours
Z direction: 4 hours



^{*10}Refer to 6. Conditions for operation, transport and storage mentioned in [AMBIENT ENVIRONMENT](#) (p. 19, Relay Technical Information).

TYPICAL APPLICATIONS

- Intermittent wiper
- Cruise control
- Power windows
- Auto door lock
- Car stereo
- Car air-conditioner
- Electrically powered seats
- Electrically powered sunroof, etc.

ORDERING INFORMATION

Ex. CQ 1 - 12 V

Contact arrangement	Coil voltage(DC)
1 Form C	12 V

Standard packing: Carton(tube package) 40pcs. Case: 800pcs.

TYPES AND COIL DATA (at 20°C 68°F)

Part No.	Nominal voltage, V DC	Pick-up voltage, V DC (Initial)*	Drop-out voltage, V DC (Initial)	Coil resistance, Ω	Nominal operating current, mA	Nominal operating power, mW	Usable voltage range, V DC
CQ1-12V	12	Max. 7.2	Min. 1.0	225±10%	53.3±10%	640	10 to 16

* Other pick-up voltage types are also available. Please contact us for details.

DIMENSIONS

mm inch

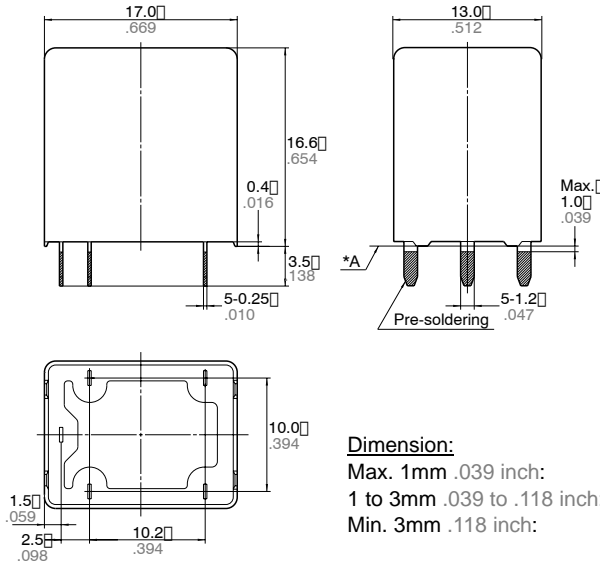

PC board pattern (Bottom view)

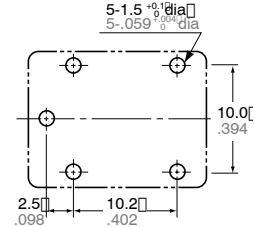

Tolerance: ±0.1 ±.004

Schematic (Bottom view)

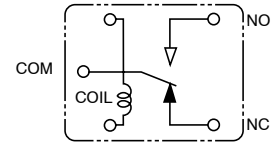

* Dimensions (thickness and width) of terminal specified in this catalog is measured before pre-soldering. Intervals between terminals is measured at A surface level.

EXAMPLE OF CIRCUIT

Control circuit for intermittent wiper motor

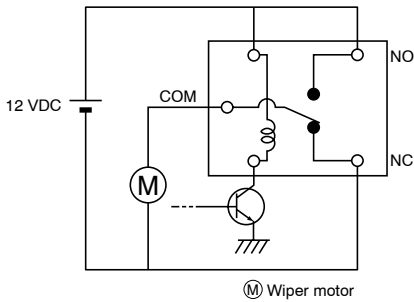

REFERENCE DATA

1-(1). Coil temperature rise (at room temperature)
 Sample: CQ1-12V, 5pcs
 Contact carrying current: 10A, 15A, 20A
 Ambient temperature: Room temperature

1-(2). Coil temperature rise (at 85°C 185°F)
 Sample: CQ1-12V, 5pcs
 Contact carrying current: 10A, 15A
 Ambient temperature: 85°C 185°F

2. Max. switching capability (Resistive load)

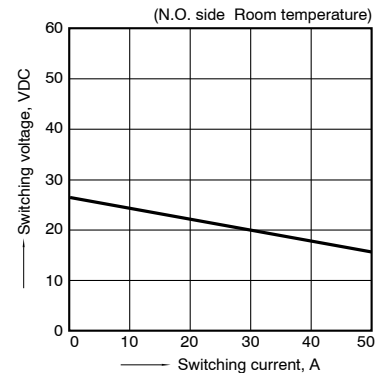
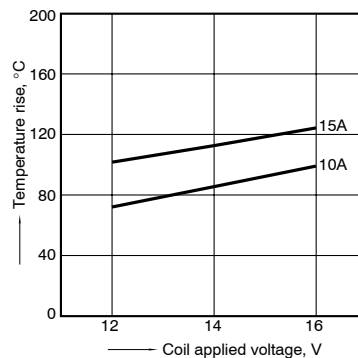
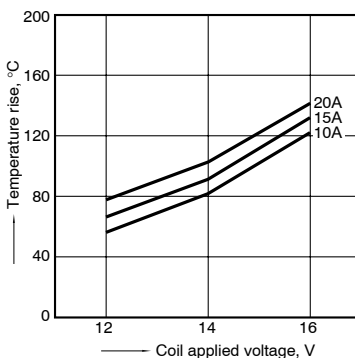

3. Ambient temperature and operating temperature range

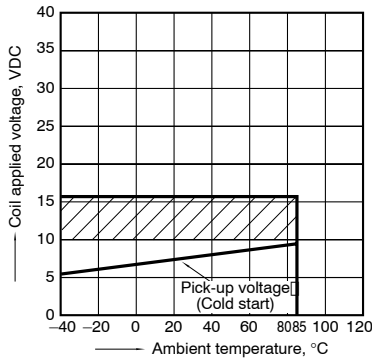

4. Ambient temperature characteristics

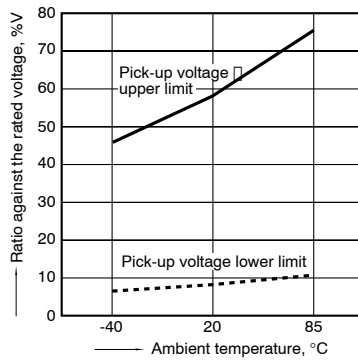

5. Distribution of pick-up and drop-out voltage
Sample: CQ1-12V, 100pcs

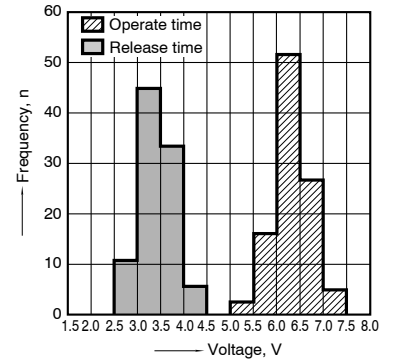

6. Distribution of operate time
Sample: CQ1-12V, 100pcs

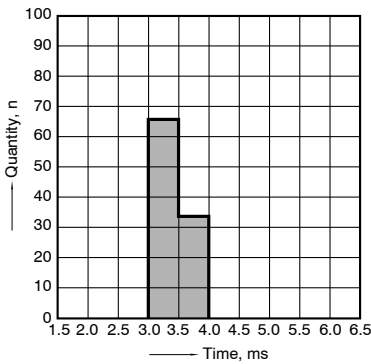

7. Distribution of release time
Sample: CQ1-12V, 100pcs
* With diode

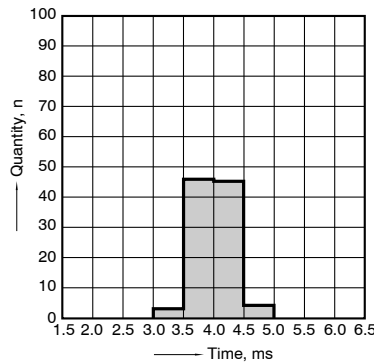

8. Electrical life test (Motor free)

Sample: CQ1-12V, 3pcs
Load: Inrush current: 30A, Steady current: 5A,
Brake current: 17A,
wiper motor actual load (free condition)
Tested voltage: 14V DC
Switching frequency: (ON:OFF = 1s:2s)
Ambient temperature: Room temperature

Circuit

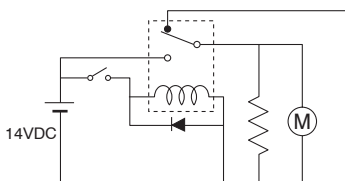

Load current waveform

Inrush current: 30A, Steady current: 5A,
Brake current: 17A

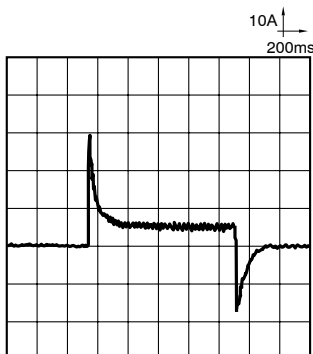

Change of pick-up and drop-out voltage

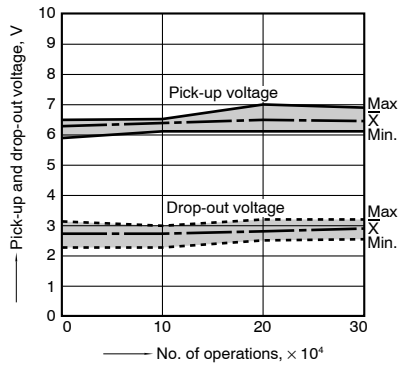

Change of contact resistance

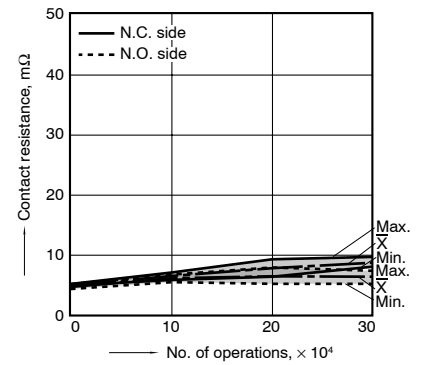

9-(1). Operation noise distribution
When operate

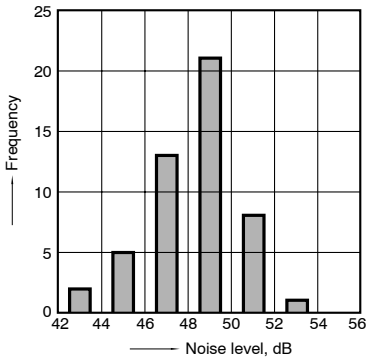

9-(2). Operation noise distribution
When release

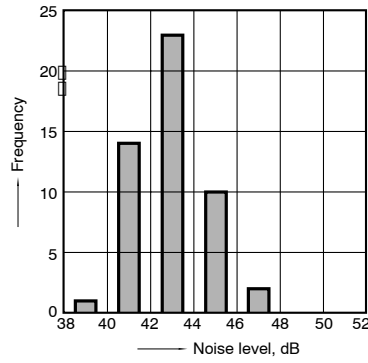

Measuring conditions

Sample: CQ1-12 V, 50 pcs.
 Equipment setting: "A" weighted, Fast, Max. hold
 Coil voltage: 12V DC
 Coil connection device: Diode
 Background noise: Approx. 20dB

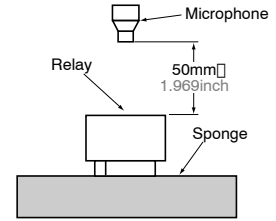

For Cautions for Use, see [Relay Technical Information](#).