

CR2032

■ Dimensions(mm)

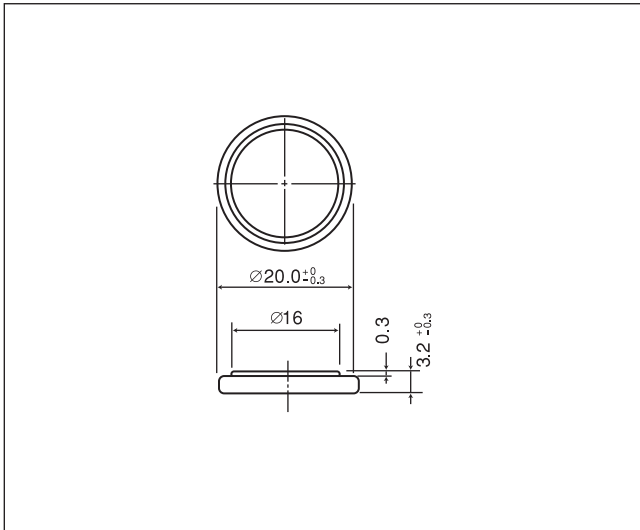

■ Specification

Nominal voltage(V)	3
Nominal capacity(mAh)	225
Continuous drain(mA)	0.2
Operating temperature(°C)	-30 to +60

■ Discharge temperature characteristics

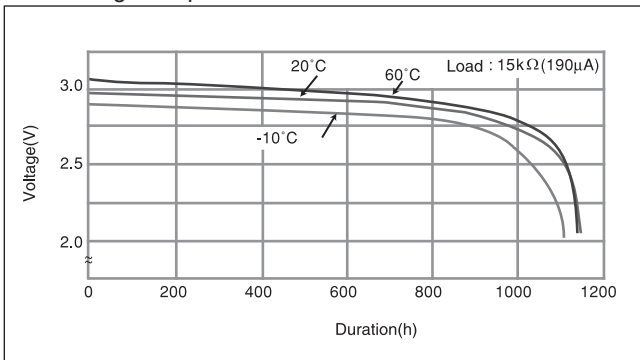

Lithium battery holders for CR2032

These battery holders are designed for sure and easy loading/ removal of Panasonic coin type lithium batteries in / from equipment enabling the batteries to fully exploit their capabilities as the backup power supply in C-MOS RAM memory and microcomputer memory. All of the battery holders are designed to prevent inverted insertion of the battery.



BCR20H4 (3 terminals)

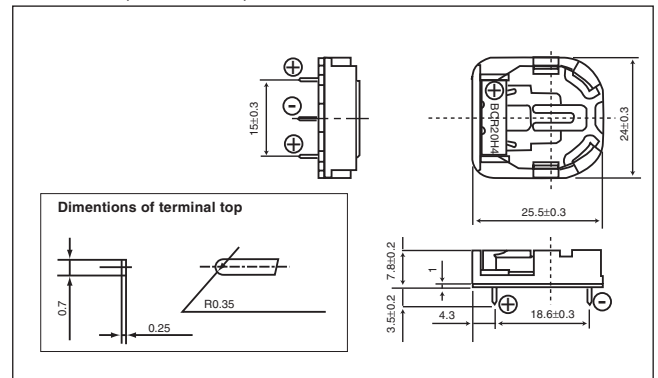

BCR20H5 (2 terminals)

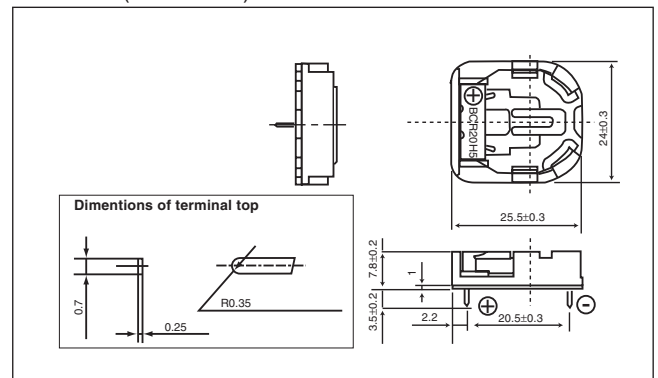

BCR20V4 (3 terminals)

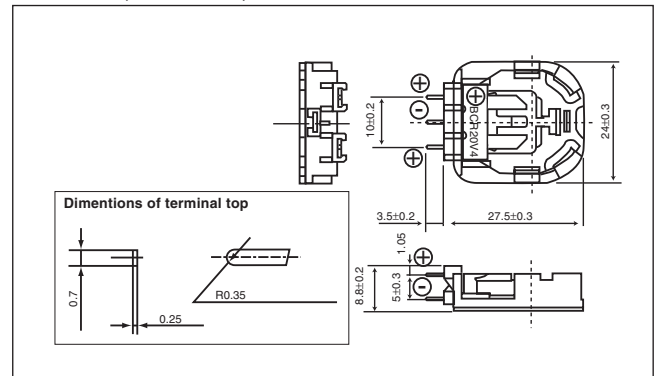

■ Precaution for washing battery holders

The battery holders can be adversely affected by some detergents use in the circuit board washing process and may result in cracks forming in the holder. Please test the holders in your washing process before use.