

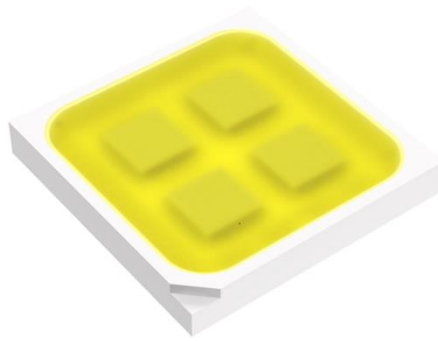

## SPECIFICATION

# 产品规格书



REFOND P/N 产品型号

RF-Q50SF\*\*A-FF-2N2

■R&D 研发

□Mass Product 量产供货

## CONTENTS 目录

<b>General Product Description 产品描述</b> .....	<b>2</b>
Key Product Features 主要产品特征 .....	2
Product Application 产品应用 .....	2
Product Nomenclature 产品命名规则 .....	2
Package Dimension 产品尺寸 .....	3
<b>Product Parameters 产品特性参数</b> .....	<b>4</b>
Flux Specification 亮度规格 ( $T_j=25^{\circ}\text{C}$ $I_F=180\text{mA}$ ) .....	4
5000K 70CRI Reference Parameters at Varied Current 不同电流光电参数参考 ( $T_j=25^{\circ}\text{C}$ ) .....	4
Opto-Electro-Thermal Characteristics 光电热参数 ( $T_j=25^{\circ}\text{C}$ $I_F=180\text{mA}$ ) .....	5
Absolute Maximum Ratings 极限参数 .....	5
Typical Opto-electrical Characteristics Curves 典型光电特性曲线 .....	6
<b>Binning Rules 分 BIN 规则</b> .....	<b>8</b>
Flux Bins 亮度 BIN ( $T_j=25^{\circ}\text{C}$ $I_F=180\text{mA}$ ) .....	8
Voltage Bins 电压 BIN ( $T_j=25^{\circ}\text{C}$ $I_F=180\text{mA}$ ) .....	8
Chromaticity Bins 色度分 BIN ( $T_j=25^{\circ}\text{C}$ $I_F=180\text{mA}$ ) .....	9
<b>Packaging 产品包装</b> .....	<b>10</b>
Packaging Specification 包装规格 .....	10
Carrier Tape Specification 载带规格 .....	10
Reel Specification 卷盘规格 .....	10
Label Specification 标签信息 .....	11
Moisture Resistant Packing 防潮包装 .....	11
Box Information 纸箱信息 .....	11
<b>Reliability 可靠性</b> .....	<b>12</b>
Test Items and Conditions 测试项目及条件 .....	12
Failure Criteria 失效判定标准 .....	13
<b>Handing Notes 产品使用说明</b> .....	<b>14</b>
Soldering Instructions 焊接说明 .....	14
Chemical Compatibility 有害化学物质 .....	15
Handling Precautions 产品使用注意事项 .....	16
<b>Revision History 版本历史</b> .....	<b>18</b>

## General Product Description 产品描述

### Key Product Features 主要产品特征

- EMC Package EMC封装
- Wide viewing angle 120° 大发光角度120°
- High lumen and efficacy, typ. 239lm & 243lm/W at 5000K,180mA  $T_j=25^{\circ}\text{C}$  高光效243lm/W
- CCT 2700K~6500K 色温2700K~6500K
- CRI 70 available 显指70
- Moisture sensitive level 3 防潮等级L-3
- RoHS compliant 符合RoHS标准

### Product Application 产品应用

- Architectural landscape lighting.建筑景观照明
- General lighting . 通用照明
- Spotlight applications.射灯类应用

### Product Nomenclature 产品命名规则

The part number designation for SMD 5050 is explained as follows

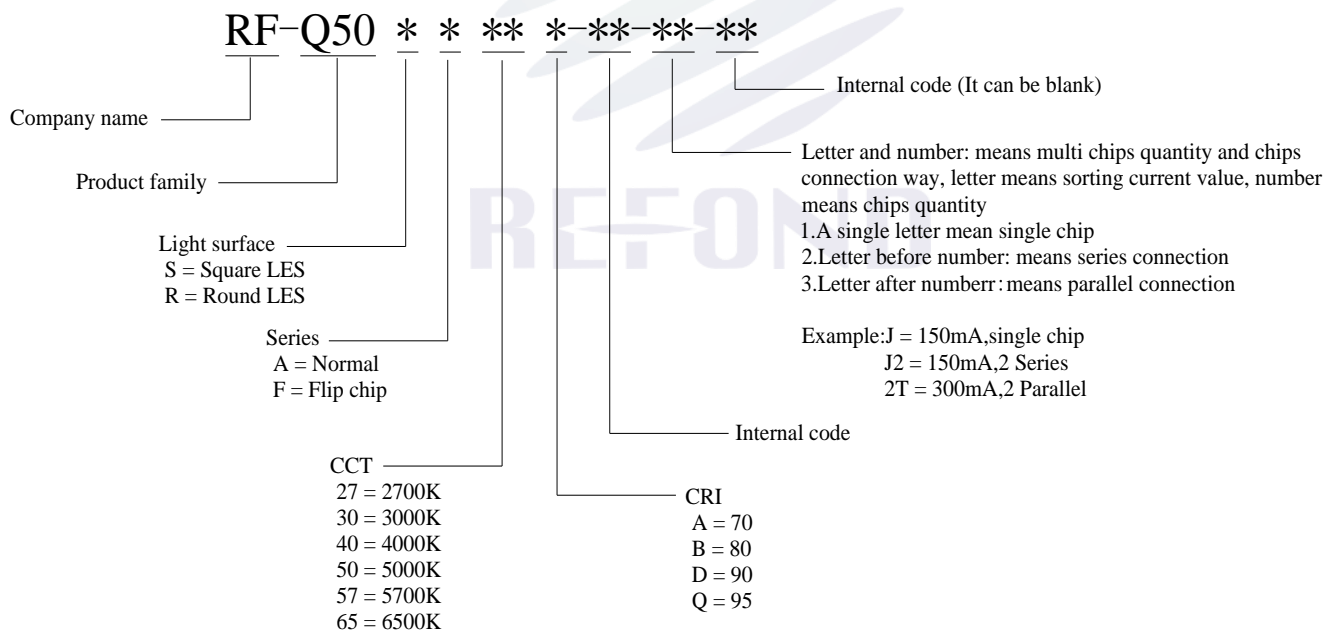

## Package Dimension 产品尺寸

Top view 正面视图

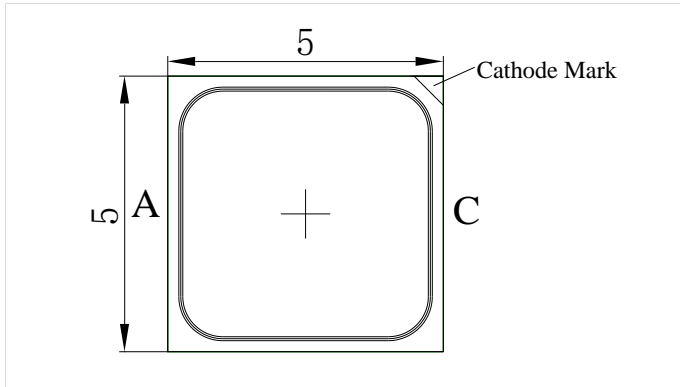

Side view 侧面视图

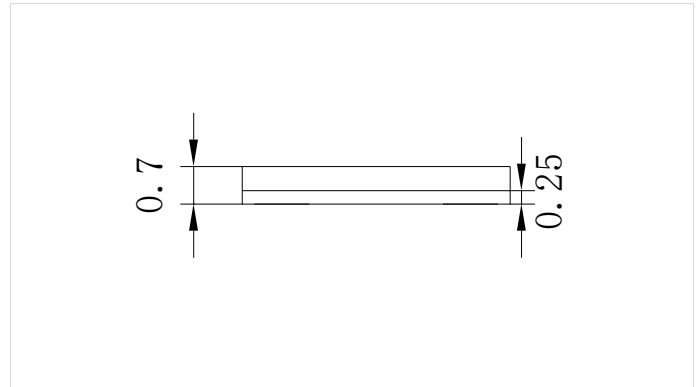

Bottom view 背面视图

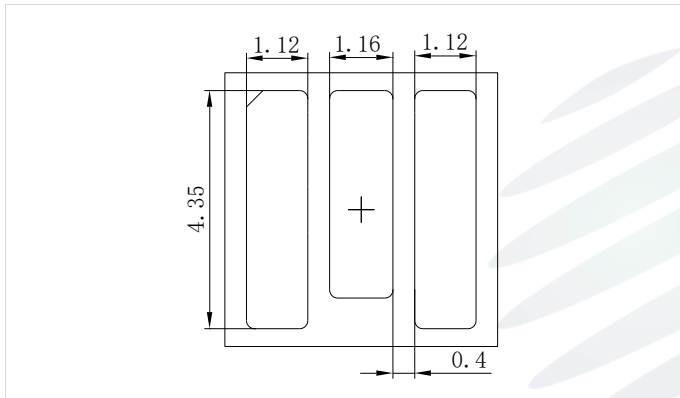

Polarity 极性标识

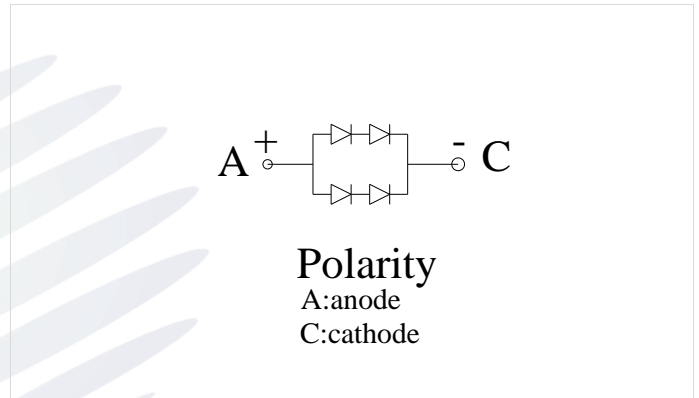

Recommended solder pad 推荐焊盘

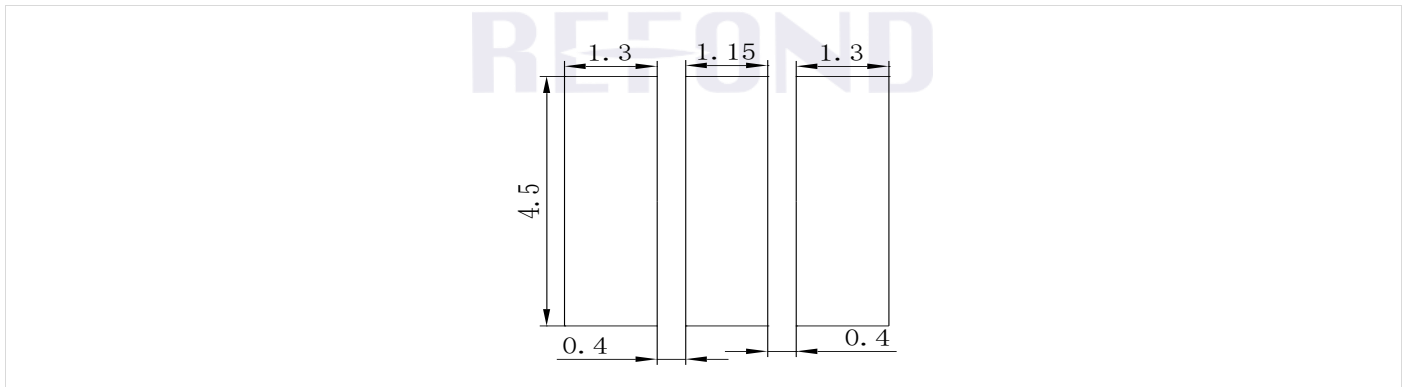

**Notes 备注:**

1. All dimensions units are millimeters 所有尺寸标注单位为毫米
2. All dimensions tolerances are  $\pm 0.1\text{mm}$  unless otherwise noted 除特别标注外, 所有尺寸公差为  $\pm 0.1$  毫米

## Product Parameters 产品特性参数

### Flux Specification 亮度规格 (T<sub>j</sub>=25°C IF=180mA)

CCT	CRI (min.)	R9 (min.)	Luminous flux (lm)			Ordering part number 订购代码	Flux bins 亮度 bin
			Min.	Typ.	Max.		
2700K	70		200	210	220	RF-Q50SF27A-FF-2N2	FD3/FD4
3000K	70		210	223	230	RF-Q50SF30A-FF-2N2	FD4/FD5
4000K	70		230	238	250	RF-Q50SF40A-FF-2N2	FD6/FD7
5000K	70		230	238	250	RF-Q50SF50A-FF-2N2	FD6/FD7
5700K	70		230	238	250	RF-Q50SF57A-FF-2N2	FD6/FD7
6500K	70		230	236	250	RF-Q50SF65A-FF-2N2	FD6/FD7

### 5000K 70CRI Reference Parameters at Varied Current 不同电流光电参数参考 (T<sub>j</sub>=25°C)

Current 电流 (mA)	Voltage 电压 (V)	Flux 亮度 (lm)	Efficacy 光效 (lm/w)	Ra 显指	CCT 色温 (K)
180	5.47	239.3	243.5	70.5	5061
350	5.65	448.2	226.8	70.4	5087
500	5.81	622.8	214.6	70.4	5111
640	5.94	777.6	204.6	70.4	5130
800	6.14	952.9	194.1	70.4	5158



## Opto-Electro-Thermal Characteristics 光电热参数 (T<sub>j</sub>=25°C IF=180mA)

Parameter 参数	Symbol 符号	Unit 单位	Values 值		
			Min.	Typ.	Max.
Forward voltage	V <sub>F</sub>	V	5.2	5.5	5.8
Viewing angle	2θ <sub>1/2</sub>	Deg.		120	
Thermal resistance	R <sub>th J-S</sub>	K/W		2	

## Absolute Maximum Ratings 极限参数

Parameter 参数	Symbol 符号	Unit 单位	Values 值	
Power dissipation 功耗 T <sub>j</sub> =25°C	P <sub>D</sub>	mW		5760
Forward current 电流 T <sub>j</sub> =25°C	I <sub>F</sub>	mA	min.	20
			max.	960
Peak forward current 峰值电流 T≤0.1ms; D≤1/10; T <sub>j</sub> =25°C	I <sub>FP</sub>	mA		1200
Reverse voltage <sup>(3)</sup> 反向电压 T <sub>j</sub> =25°C	V <sub>R</sub>	V		10
ESD (HBM)	V <sub>ESD</sub>	V		2000
Operating temperature 工作温度	T <sub>op</sub>	°C		-40~+105
Storage temperature 储存温度	T <sub>stg</sub>	°C		-40~+105
Junction temperature 结温	T <sub>J</sub>	°C		125

### Notes 备注:

1. Refond maintains ±5% tolerance on flux measurements, ±2 tolerance on CRI measurements, ±6 tolerance on R9 measurements, ±0.1V tolerance on forward voltage measurements, ±0.005 tolerance on color coordinates.  
瑞丰测试误差: 亮度±5%, CRI ±2, R9 ±6, 电压±0.1V, 色坐标±0.005。
2. All measurements were made under the standard of Refond.  
所有测试都是基于瑞丰现有的标准测试平台。
3. The devices are not designed for reverse operation, it' s intended to be operated applying a forward current under within the specified range.  
产品不可在反向电压条件下使用, 应施加极限参数之内的正向电流使用。
4. Each device must be operated strictly below the maximum ratings to ensure that it works properly and reliable.  
为确保产品可靠性, 每个产品需在极限参数内使用。
5. ESD yield is over 90% at 2000V ESD (HBM). ESD protection during products handing is needed. 90%的LED通过人体模式ESD2000V测试, 在操作时请注意静电防护。

## Typical Opto-electrical Characteristics Curves 典型光电特性曲线

Forward current vs. forward voltage  
伏安特性曲线 ( $T_j=25^\circ\text{C}$ )

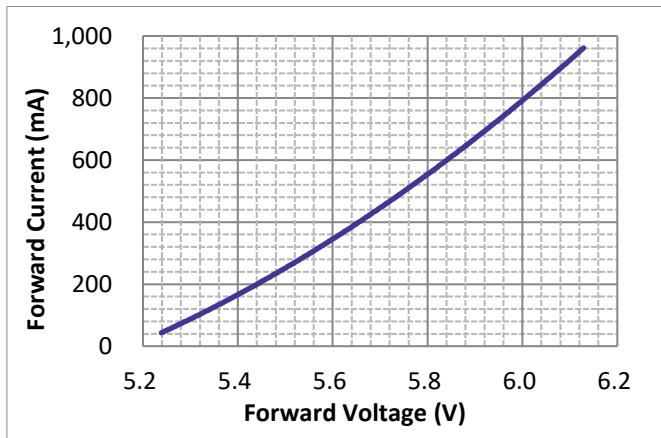

Relative luminous flux vs. forward current  
相对亮度与正向电流曲线 ( $T_j=25^\circ\text{C}$ )

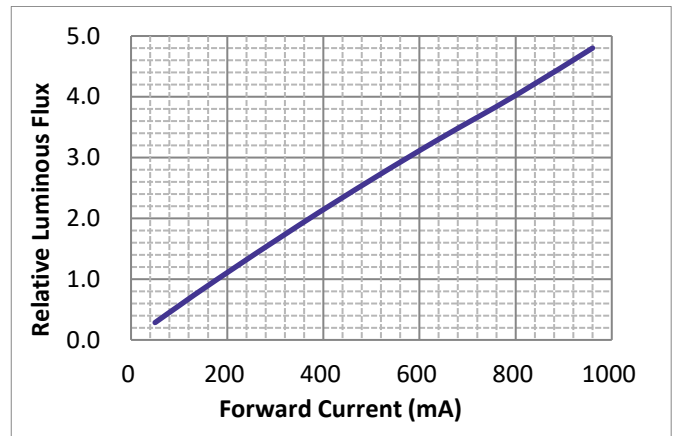

Relative luminous flux vs.  $T_s$  temperature  
相对亮度与温度曲线 ( $I_F=800\text{mA}$ )

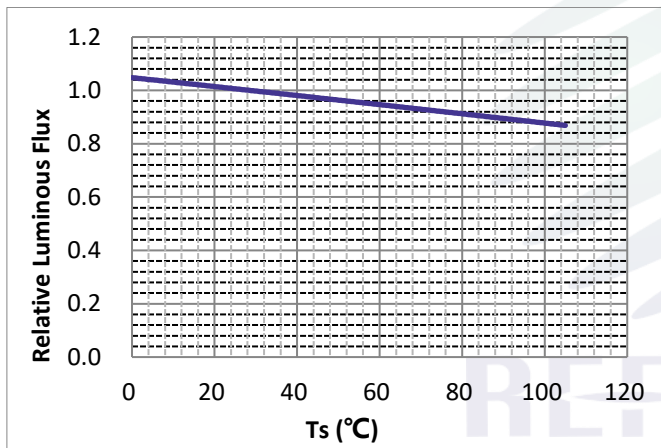

Forward voltage vs.  $T_s$  temperature  
电压与温度曲线 ( $I_F=800\text{mA}$ )

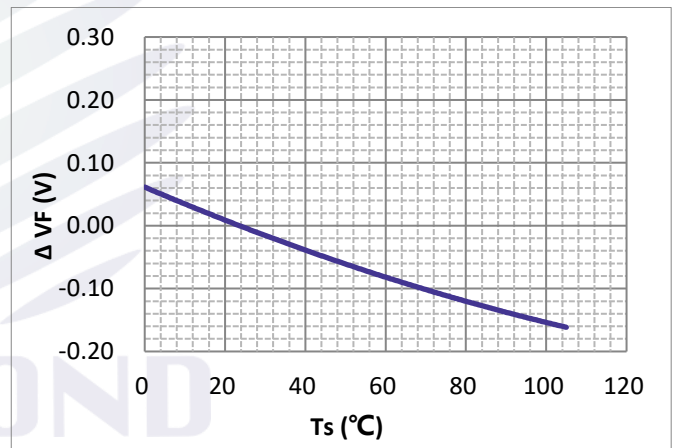

$\Delta\text{CIE-x/y}$  vs. forward current  
 $\Delta\text{CIE-x/y}$  与电流曲线 ( $T_j=25^\circ\text{C}$ )

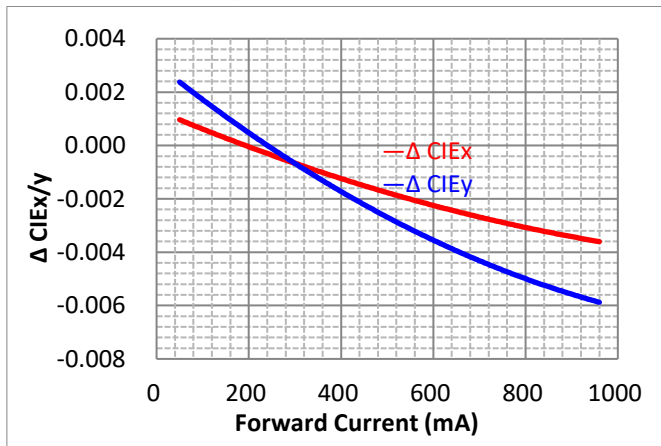

$\Delta\text{CIE-x/y}$  vs.  $T_s$  temperature  
 $\Delta\text{CIE-x/y}$  与温度曲线 ( $I_F=800\text{mA}$ )

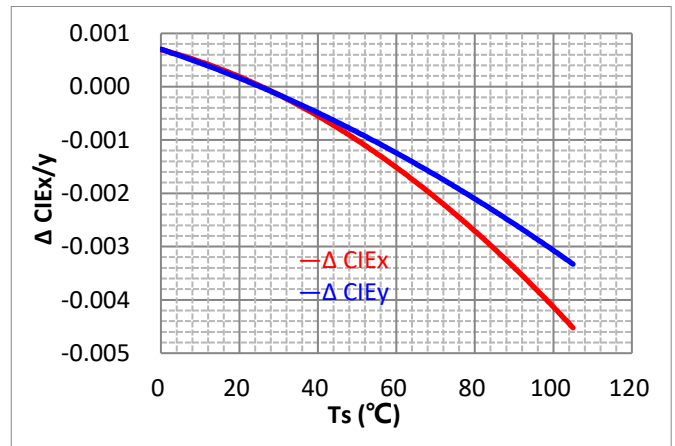

Typical radiation diagram  
 典型辐射特性曲线

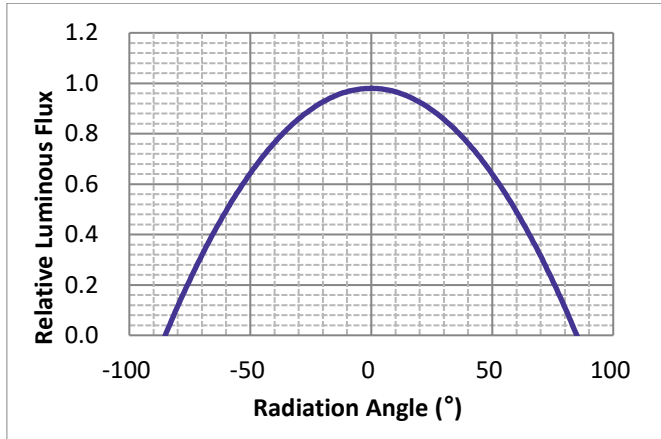

Max. forward current vs. Ts temperature  
 最大电流与 Ts 特性曲线 ( $T_j \leq 125^\circ\text{C}$ )

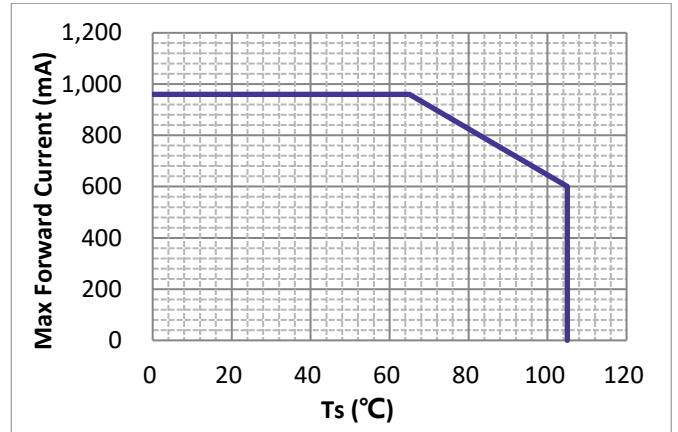

Typical spectrum distribution  
 典型光谱分布

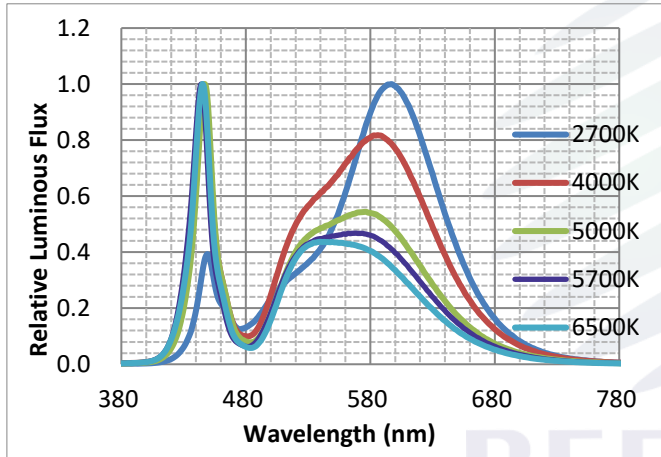

## Binning Rules 分 BIN 规则

### Flux Bins 亮度 BIN ( $T_j=25^{\circ}\text{C}$ IF=180mA)

Bin	Luminous flux (lm)	
	Min.	Max.
FD3	200	210
FD4	210	220
FD5	220	230
FD6	230	240
FD7	240	250

### Voltage Bins 电压 BIN ( $T_j=25^{\circ}\text{C}$ IF=180mA)

Bin	Voltage (V)	
	Min.	Max.
P2	5.2	5.4
Q1	5.4	5.6
Q2	5.6	5.8
R1	5.8	6.0



## Chromaticity Bins 色度分 BIN ( $T_j=25^{\circ}\text{C}$ $I_F=180\text{mA}$ )

CIE 1931 chromaticity diagram

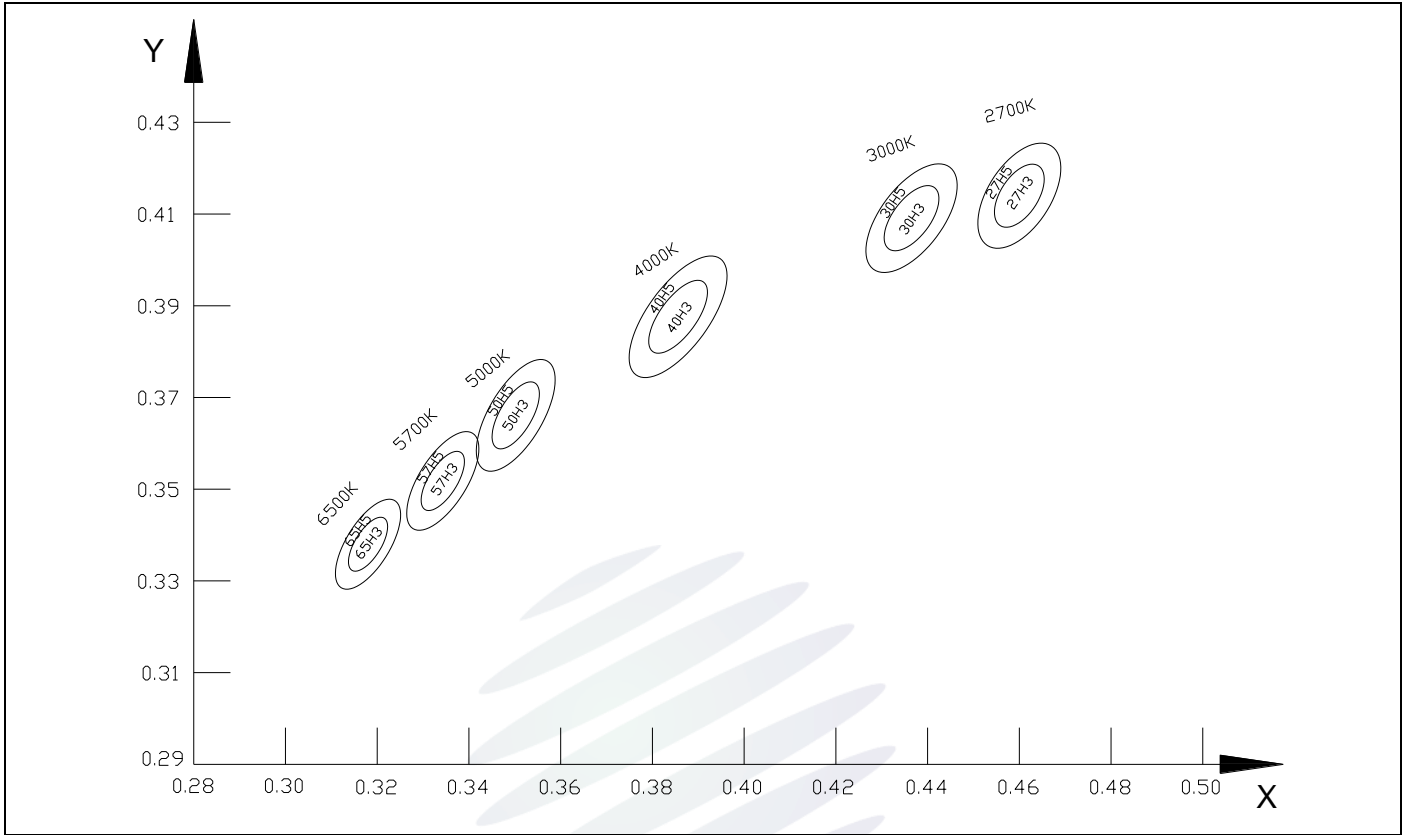

ANSI 3 - 5 Step					
Bin Code	X	Y	a	b	$\theta$
27H3	0.4578	0.4101	0.0081	0.0042	53°42'
30H3	0.4339	0.4033	0.00834	0.00408	53°13'
40H3	0.3818	0.3797	0.00939	0.00402	53°43'
50H3	0.3446	0.3551	0.00822	0.00354	59°37'
57H3	0.3287	0.3425	0.00746	0.0032	59°09'
65H3	0.3123	0.3283	0.00937	0.00399	58°34'
27H5	0.4578	0.4101	0.01350	0.00700	53°42'
30H5	0.4339	0.4033	0.01390	0.00680	53°13'
40H5	0.3818	0.3797	0.01565	0.00670	53°43'
50H5	0.3446	0.3551	0.01370	0.00590	59°37'
57H5	0.3287	0.3425	0.01243	0.00533	59°09'
65H5	0.3123	0.3283	0.01561	0.00665	58°34'

## Packaging 产品包装

### Packaging Specification 包装规格

Package:2000pcs/reel. 包装: 每卷 2000pcs。

### Carrier Tape Specification 载带规格

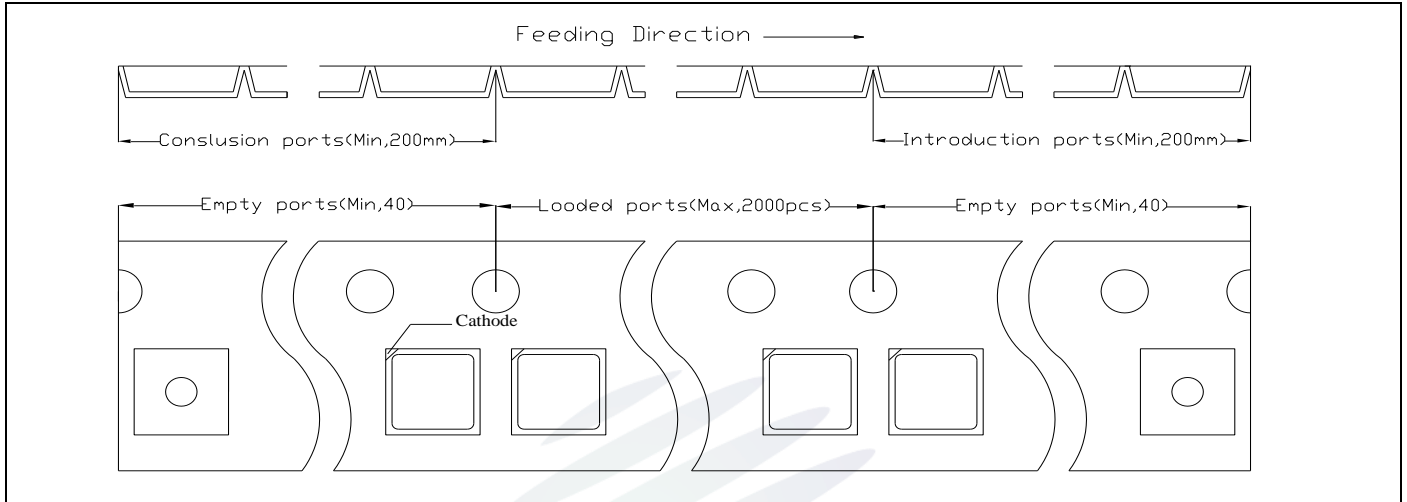

### Reel Specification 卷盘规格

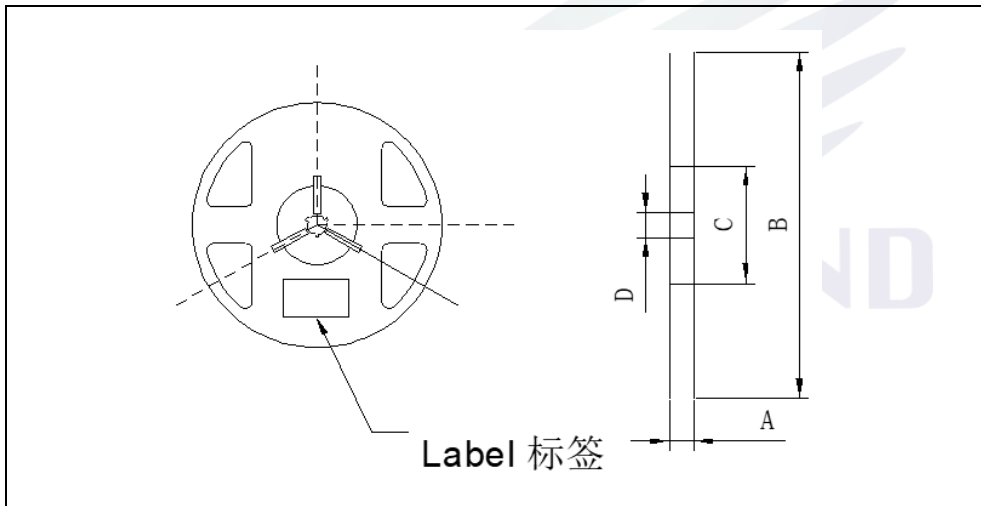
 <p>The diagram shows a top-down view of a reel with a 'Label 标签' and a side view with dimensions A, B, C, and D. Dimension A is the width of the reel, B is the diameter, C is the inner diameter, and D is the thickness.</p>	2000pcs	
	A	14.9±0.3mm
	B	177.8±1mm
	C	58.5±0.5mm
	D	13.5±0.2mm

#### Notes 备注:

The tolerances unless mentioned  $\pm 0.1\text{mm}$ . Unit : mm注: 未注公差为 $\pm 0.1$ 毫米, 尺寸单位: 毫米。

**Label Specification 标签信息**

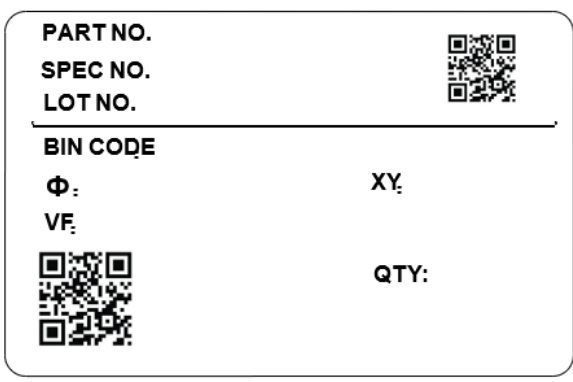
	<b>PART NO.</b>	Part Number 品名
	<b>SPEC NO.</b>	Spec Number 规格
	<b>LOT NO.</b>	Lot Number 批次号
	<b>BIN CODE</b>	Bin Code 参数代码
	<b>Φ</b>	Luminous Flux 光通量
	<b>XY</b>	Chromaticity Bin 色区
	<b>VF</b>	Forward Voltage 正向电压
	<b>QTY</b>	Packing Quantity 数量
	<b>DATE</b>	Made Date 生产日期

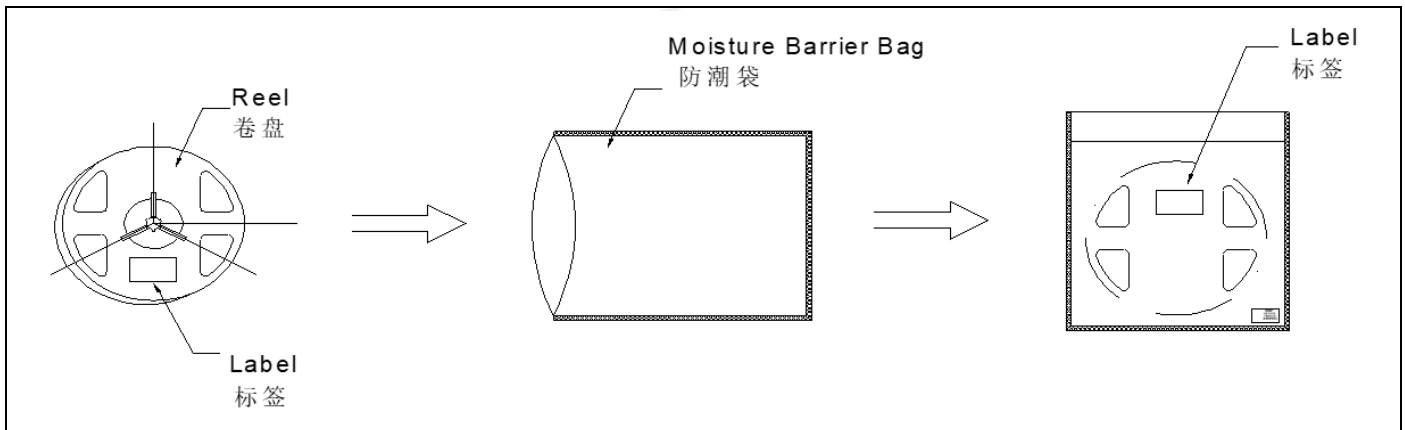
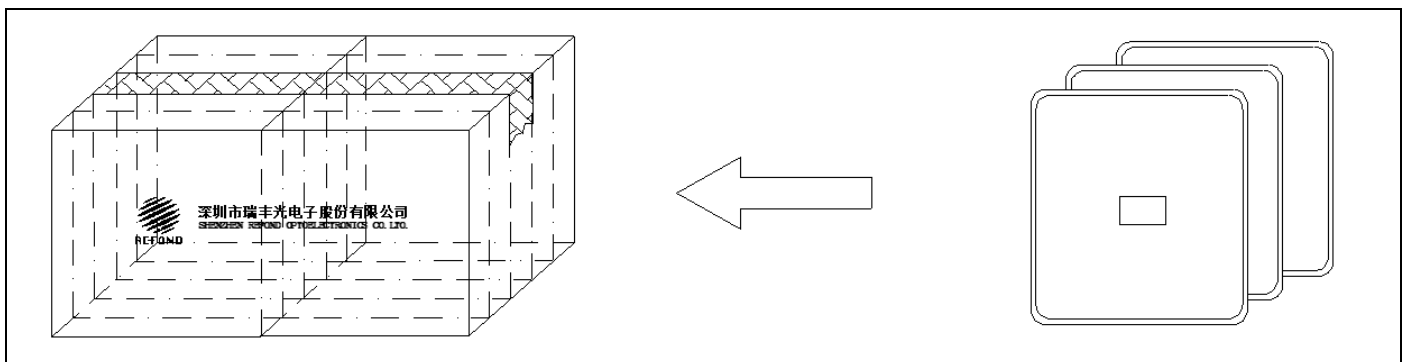
**Moisture Resistant Packing 防潮包装**

**Box Information 纸箱信息**

## Reliability 可靠性

### Test Items and Conditions 测试项目及条件

Test Items 项目	Ref. Standard 参考标准	Test Condition 测试条件	Duration 时间	Quantity 数量	Ac/Re 接收/拒收
Thermal shock 冷热冲击	JEITAED-4701 300 307	-40°C 15min ↑↓10s 100°C 15min	300 cycles	10pcs	0/1
High temperature storage 高温储存	JEITAED-4701 200 201	TA=105°C	1000hrs	10pcs	0/1
Low temperature storage 低温储存	JEITA ED-4701 200 202	TA=-40°C	1000hrs	10pcs	0/1
Room temperature life test 常温通电	JESD22-A108	TA=25°C IF=800mA	1000hrs	10pcs	0/1
Wet high temperature life test 高温高湿通电	JESD22-A101	TA=60°C RH=90% IF=800mA	1000hrs	10pcs	0/1



## Failure Criteria 失效判定标准

Test Items 项目	Symbol 符号	Test Condition 测试条件	Failure Criteria 失效标准	
			Min. 最小	Max. 最大
Forward Voltage 正向电压	VF	IF=180mA	-	(U.S.L*)x1.1
Reverse Current 反向电流	IR	VR = 10V	-	(U.S.L*)x2.0
Luminous Flux 光通量	Φ	IF=180mA	(L.S.L*)x0.7	-

### Notes 备注:

1. U.S.L: Upper standard level 规格上限; L.S.L: Lower standard level 规格下限。
2. The above reliability tests are based on the verification of a single/strip LED of Refond's existing experimental platform, the reliability experimental was taken under good heat dissipation conditions. When customers applies the LED to the series and parallel circuit, should take consideration of all the factors such as the current, voltage distribution, heat dissipation and others. 以上可靠性测试是基于瑞丰现有实验平台单颗/条 LED 在良好散热条件验证下的结果。客户端将 LED 应用于串、并联线路时, 需自行评估电流、电压分配、散热等问题。
3. The technical information shown in the data sheets are limited to the typical characteristics and circuit examples of the referenced products. It does not constitute the warranting of industrial property nor the granting of any license. 以上技术数据仅为产品的典型值, 只作为参考, 不作为任何应用条件及应用方式的保证。



## Handing Notes 产品使用说明

### Soldering Instructions 焊接说明

#### Reflow soldering 回流焊

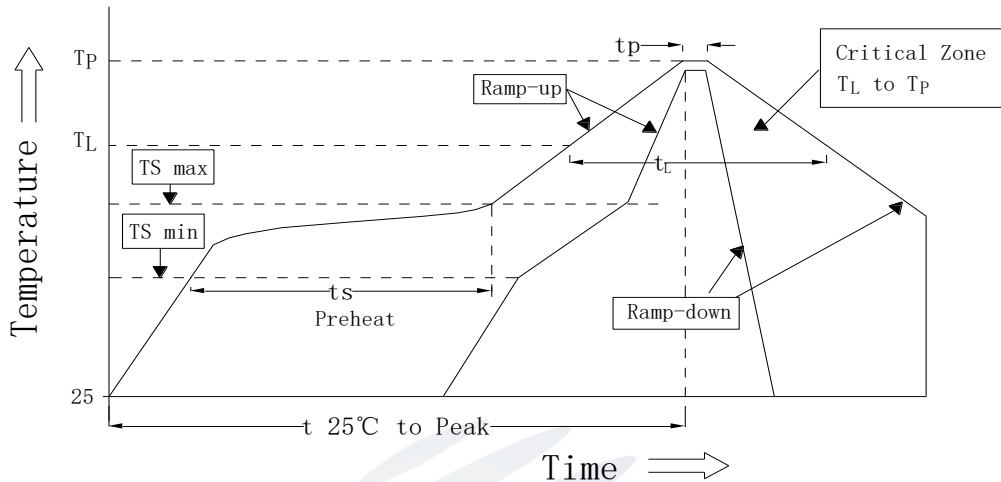

Preheat temperature 推荐预热温度 $T_{smin} \sim T_{smax}$	150°C~200°C
Preheat time 预热时间 $t_s$	60s~120s
Ramp-up rate to $T_p$ 升温速率 $T_{smax} \rightarrow T_p$	Max 3°C/s 最高3°C/秒
Liquids temperature 液相温度 $T_L$	217°C
Time above liquids temperature 液相温度时间 $t_L$	Max 60s 最大60s
Peak temperature 峰值温度 $T_p$	240°C
Time within 5°C of the peak temperature $T_p-5^\circ\text{C}$ 峰值温度时间 $t_p$	Max 30s 最大 30s
Ramp-down rate 降温速率	Max 6°C/s 最大 6°C/s
Time 25°C → $T_p$ 室温到峰值温度时间	Max 480s 最大 480s

#### Notes 备注:

- The number of reflow soldering should not exceed two times. If the time interval between two reflow soldering times exceeds 4 hours, the LED may be damaged due to moisture absorption. 回流焊次数不可以超过两次，两次回流焊的时间间隔如果超过4小时，LED可能因吸湿而损坏。
- Do not press the light emitting surface while soldering in high temperature. 高温焊接时不要用力压产品胶体发光面。

## Iron Soldering 烙铁焊接

1. When manually soldering, the soldering iron temperature must be less than 300°C and the time must not exceed 3s. 手工焊接时, 烙铁温度必须小于 300°C, 时间不超过 3 秒。
2. Manual soldering can only be done once. 手工焊接只可焊接一次。

## Soldering Repair 焊接修补

LED cannot be repaired after reflow soldering. If repair is necessary, a double-ended soldering iron must be used, and it should be confirmed in advance whether this method will damage the characteristics of the LED itself. LED 回流焊后不可修补, 当必须修补时, 必须使用双头烙铁, 且应事先确认此种方式会不会损坏 LED 本身的特性。

## Cautions 注意事项

1. The LED light emitting surface is a soft silicone, pressing the surface hard will affect the reliability of the LED. Therefore, precautions should be taken to avoid pressing the device. When using a nozzle, ensure that the pressure applied to the surface will not damage the LED. LED 发光面为软的硅胶, 用力按压胶体表面会影响 LED 可靠性, 因此应有预防措施避免在按压器件, 当使用吸嘴时, 应确保施加到胶体表面的压力不会损坏 LED。
2. Do not solder LED on a curved PCB board, and do not bend the PCB after soldering. LED 灯珠不要焊接在弯曲的 PCB 板上, 焊接之后, 也不要弯折线路板。
3. During the cooling process after reflow soldering, do not apply external force to the material, do not vibrate it, and do not use drastic cooling methods. 回流焊之后冷却过程中, 不要对材料施加外力, 也不要震动, 不要采用激剧冷却的方式。

## Chemical Compatibility 有害化学物质

1. It is recommended that the sulfur element and compound content in the LED working environment and LED auxiliaries should not exceed 100PPM, but Refond does not provide quality guarantee. 建议 LED 工作环境及与 LED 适配的材料中硫元素及化合物成份不可超过 100PPM, 但瑞丰不品质担保。
2. To prevent foreign substances from entering the LED and causing damage to the LED, the LED environment and the auxiliaries used, etc., require that the single bromine content is less than 900PPM, the single chlorine content is less than 900PPM, and the total content of bromine and chlorine must be less than 1500PPM. This is Refond suggestion and does not provide any quality guarantee. 为防止外界物质进入 LED 内部造成 LED 的损伤, LED 所处环境及所用套件等, 单一的溴元素含量要求小于 900PPM, 单一氯元素含量要求小于 900PPM, 溴元素与氯元素总含量必须小于 1500PPM. 这是瑞丰的建议, 不作任何品质担保。
3. The volatile substances in the application auxiliaries will penetrate into the interior of the LED. When the power is on, photons and heat are generated, which will cause the LED to change color and then cause light decay. Knowing the auxiliaries materials in advance can avoid these problems. Refond opposes the use of any substances or materials that are harmful to the performance or reliability of LED devices, whether these materials have been confirmed or are only suspected of being harmful. For specific uses

and use environments, Refond recommends compatibility testing of all substances and materials. When mounting LEDs, do not use adhesives that can produce organic volatile gases. 应用套件中的挥发性物质会渗透到 LED 内部，在通电产生光子及热的条件下，会导致 LED 变色，进而造成光衰，提前了解套件材料能够避免产生这些问题。瑞丰反对使用任何对 LED 器件的性能或者可靠性有害的物质或材料，不管这些材料是已经证实了的还是仅仅怀疑有害。针对特定的用途和使用环境，瑞丰建议对所有的物质和材料进行相容性的测试。在贴装 LED 时候，不要使用能产生有机挥发性气体的粘结剂。

## Handling Precautions 产品使用注意事项

1. Use appropriate tools to clamp the material from the side. Do not press the LED light emitting surface directly with your hands or sharp metal, as it may damage the internal circuit. 应使用适当的工具从材料侧面夹取，不可直接用手或尖锐金属压产品发光面，它可能会损坏内部电路。

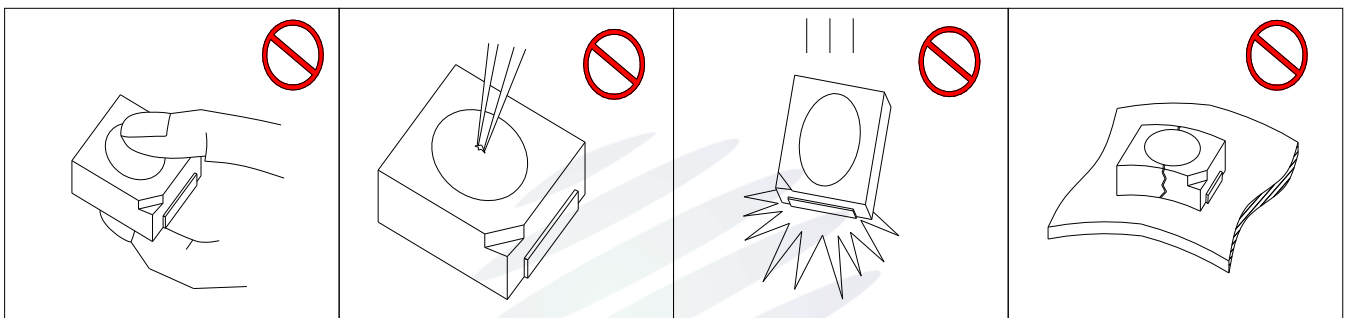

2. When designing a circuit, the current through the LED cannot exceed the specified maximum value. At the same time, a protective resistor must be used. Otherwise, a small voltage change will cause a large current change, which may cause product damage. The circuit design must ensure that only when the forward voltage changes when turning on or off, do not apply reverse voltage, otherwise it will damage the LED. 设计电路时，通过 LED 的电流不能超过规定的最大值，同时还需使用保护电阻，否则微小的电压变化将会引起较大电流变化，可能导致产品损毁。电路设计必须保证只有在开启或者关闭的时候出现正向电压的变化，不要施加反压，否则会损坏 LED。
3. LED characteristics are prone to heat changes due to their own heat and changes in ambient temperature. Temperature increases will reduce LED efficacy and result in color shift, so heat dissipation issues should be fully considered during design. LED 特性容易因为自身的发热和环境的温度改变而改变，温度升高会降低 LED 发光效率，影响发光颜色，所以在设计时应充分考虑散热问题。
4. Compared with other encapsulating glues, silicone is a soft material and its surface easily absorbs dirt. Special attention should be paid when using the LED. When the cleanliness of the LED is required, appropriate cleaning methods are required after reflow soldering. We recommend using isopropyl alcohol as a cleaning agent. If other cleaning agents are needed, it must be ensured that the package will not be damaged. Ultrasonic cleaning may damage the LED and is not recommended. 与其他封装胶相比，硅胶通常较软，表面易吸附脏物，应用时应特别注意，当对产品洁净度要求较高时，回流焊以后需要采用恰当的清洗方式，我们推荐用异丙醇作清洗剂，如需要用到其他清洗剂，必须保证不会破坏封装体，超声清洗可能会对 LED 带来损害，不推荐这种清洗方式。

5. Recommended storage and baking condition. 建议的储存及烘烤条件。

Conditions 种类	Temperature 温度	Humidity 湿度	Time 时间
Storage Before Opening Aluminum Bag 拆包前	≤30°C	≤75%	Within 1 year from shipping 一年内
Storage After Opening Aluminum Bag 拆包后	≤30°C	≤60%	168hours 168小时
Baking 烘烤	60±5°C	≤5%	≥24hours 大于24小时

6. If the package bag is bloated or damaged, please contact sales staff for assistance. 如果包装胀气或者破损, 请联系销售人员协助处理。
7. LEDs are easily broken down by static electricity overcurrent, so static electricity protection is required. LED 极易被静电过流击穿, 需要做好静电防护。
8. For other matters needing attention, please refer to the relevant information of Refond. 其它注意事项请参照瑞丰相关资料。



## Revision History 版本历史

Date日期	Revisor修订者	Version版本	Verifier审核	Remarks备注
2025-12-12	李祖俊	1.0	任艳艳	初版发行





创新科技. 丰富人类生活!  
Innovation enriches life