



2SA1371/2SC3468

High-Definition CRT Display, Video Output Applications

Use

- Color TV chroma output and high breakdown voltage driver.

Features

- High breakdown voltage : $V_{CE0} \geq 300V$.
- Small reverse transfer capacitance and excellent high frequency characteristic
: $C_{re} = 1.8pF$ (NPN), $2.3pF$ (PNP).
- Adoption of MBIT process.

() : 2SA1371

Specifications

Absolute Maximum Ratings at $T_a = 25^\circ C$

Parameter	Symbol	Conditions	Ratings	Unit
Collector-to-Base Voltage	V_{CBO}		(-)300	V
Collector-to-Emitter Voltage	V_{CEO}		(-)300	V
Emitter-to-Base Voltage	V_{EBO}		(-)5	V
Collector Current	I_C		(-)100	mA
Collector Current (Pulse)	I_{CP}		(-)200	mA
Collector Dissipation	P_C		1.0	W
Junction Temperature	T_J		150	$^\circ C$
Storage Temperature	T_{stg}		-55 to +150	$^\circ C$

Package Dimensions

unit:mm

2006B

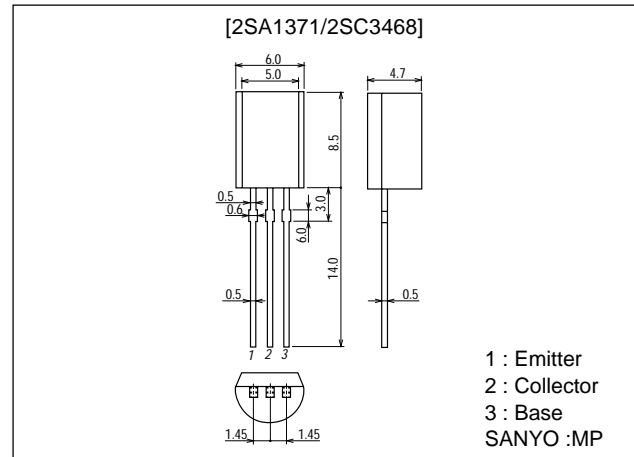

Electrical Characteristics at $T_a = 25^\circ C$

Parameter	Symbol	Conditions	Ratings			Unit
			min	typ	max	
Collector Cutoff Current	I_{CBO}	$V_{CB} = (-)200V, I_E = 0$			(-)0.1	μA
Emitter Cutoff Current	I_{EBO}	$V_{EB} = (-)4V, I_C = 0$			(-)0.1	μA
DC Current Gain	h_{FE}	$V_{CE} = (-)10V, I_C = (-)10mA$	40*		320*	
Gain-Bandwidth Product	f_T	$V_{CE} = (-)30V, I_C = (-)10mA$		150		MHz
Collector-to-Emitter Saturation Voltage	$V_{CE(sat)}$	$I_C = (-)20mA, I_B = (-)2mA$			(-)0.6	V
Base-to-Emitter Saturation Voltage	$V_{BE(sat)}$	$I_C = (-)20mA, I_B = (-)2mA$			(-)1.0	V

* : The 2SA1371/2SC3468 are classified by 10mA h_{FE} as follows :

Continued on next page.

Rank	C	D	E	F
h_{FE}	40 to 80	60 to 120	100 to 200	160 to 320

■ Any and all SANYO products described or contained herein do not have specifications that can handle applications that require extremely high levels of reliability, such as life-support systems, aircraft's control systems, or other applications whose failure can be reasonably expected to result in serious physical and/or material damage. Consult with your SANYO representative nearest you before using any SANYO products described or contained herein in such applications.

■ SANYO assumes no responsibility for equipment failures that result from using products at values that exceed, even momentarily, rated values (such as maximum ratings, operating condition ranges, or other parameters) listed in products specifications of any and all SANYO products described or contained herein.

SANYO Electric Co., Ltd. Semiconductor Company

TOKYO OFFICE Tokyo Bldg., 1-10, 1 Chome, Ueno, Taito-ku, TOKYO, 110-8534 JAPAN

2SA1371/2SC3468

Continued from preceding page.

Parameter	Symbol	Conditions	Ratings			Unit
			min	typ	max	
Collector-to-Base Breakdown Voltage	$V_{(BR)CBO}$	$I_C = (-)10\mu A, I_E = 0$	(-)300			V
Collector-to-Emitter Breakdown Voltage	$V_{(BR)CEO}$	$I_C = (-)1mA, R_{BE} = \infty$	(-)300			V
Emitter-to-Base Breakdown Voltage	$V_{(BR)EBO}$	$I_E = (-)10\mu A, I_C = 0$	(-)5			V
Output Capacitance	C_{ob}	$V_{CB} = (-)30V, f = 1MHz$		2.6		pF
				(3.1)		pF
Reverse Transfer Capacitance	C_{re}	$V_{CB} = (-)30V, f = 1MHz$		1.8		pF
				(2.3)		pF

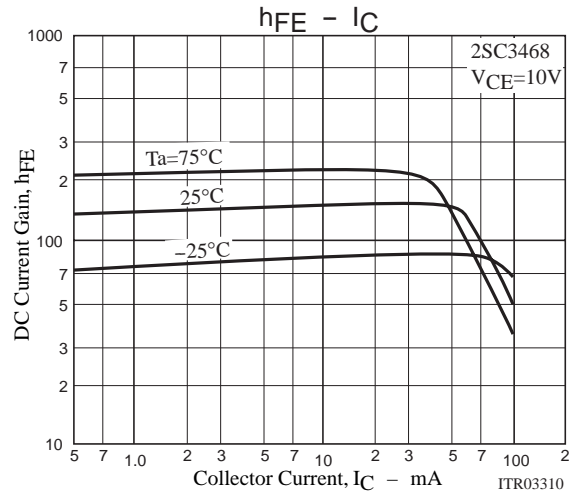
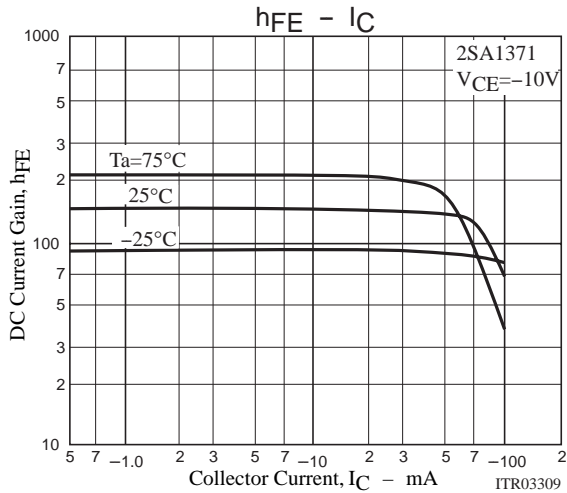
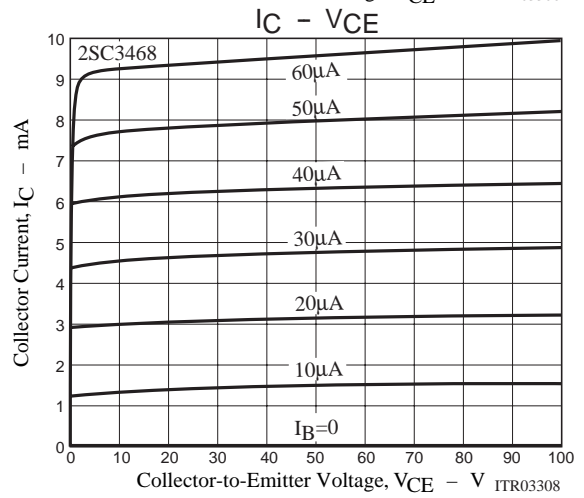
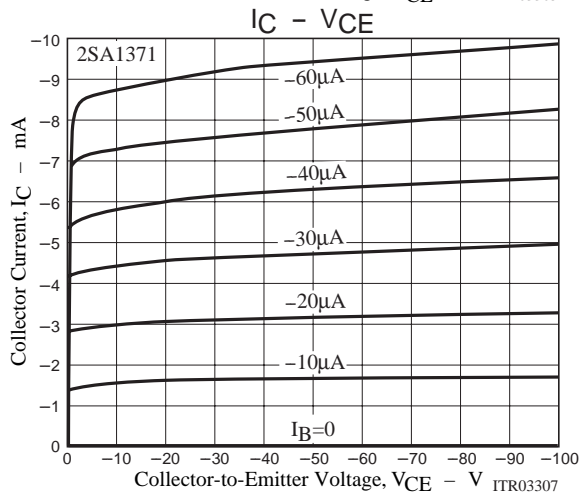
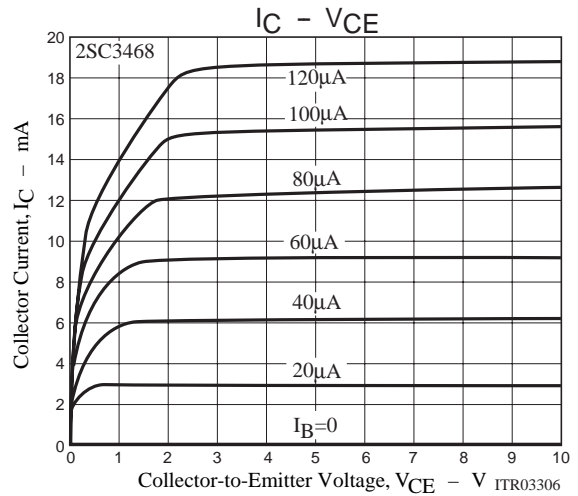
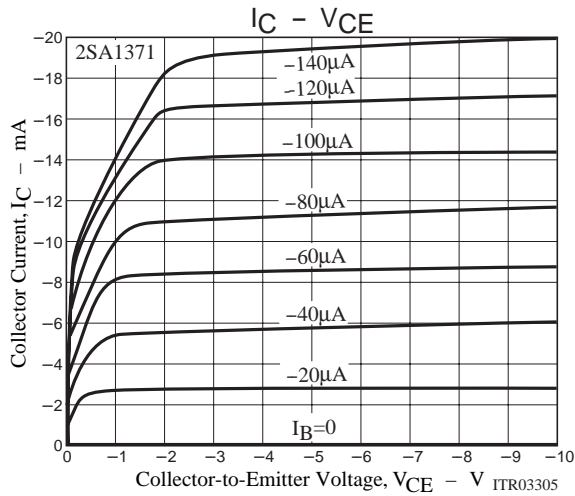

2SA1371/2SC3468

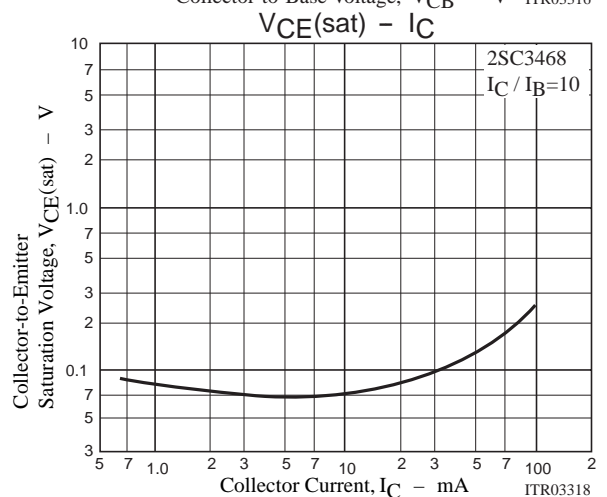
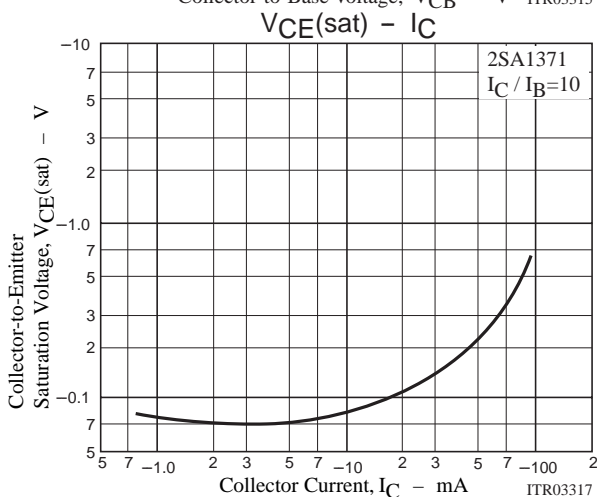
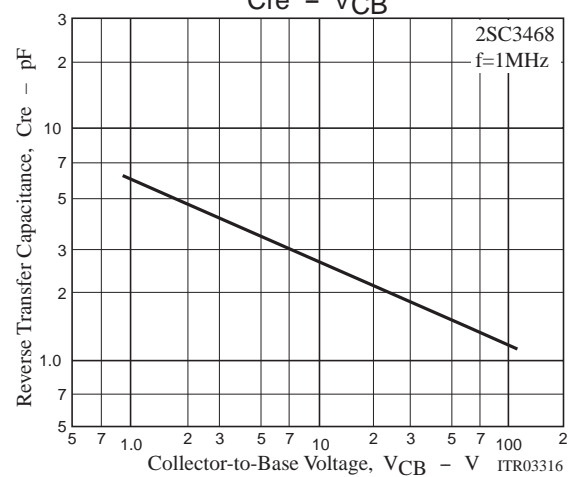
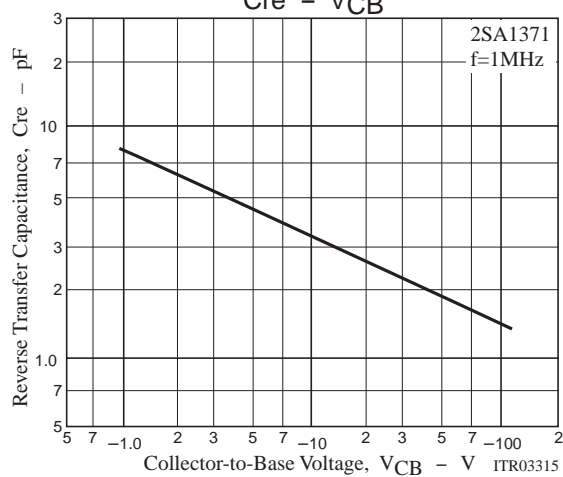
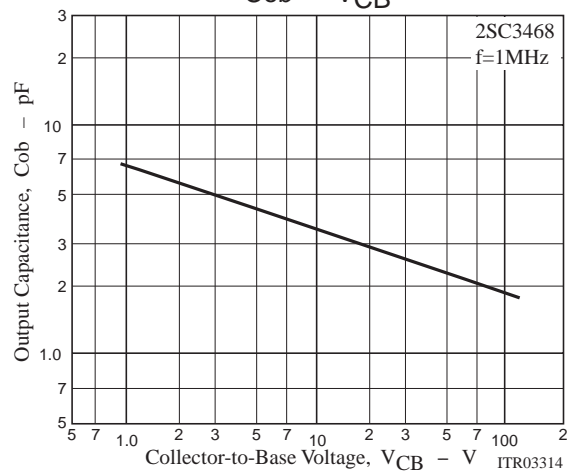
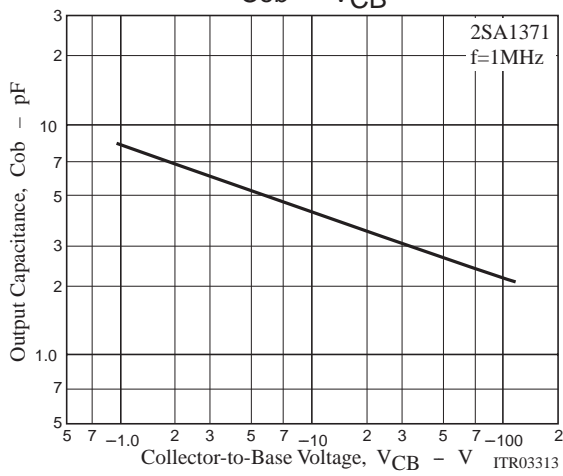
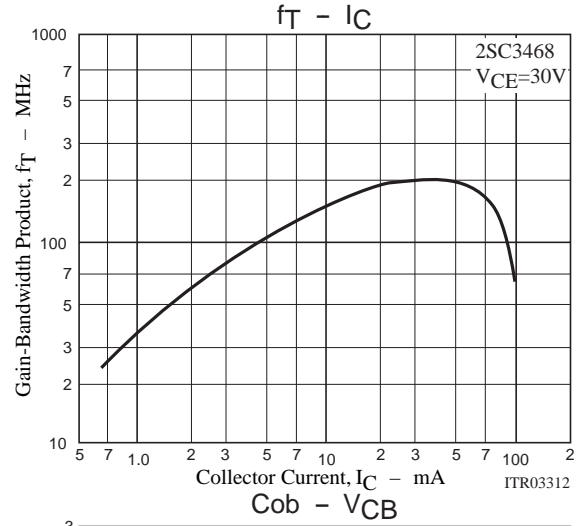
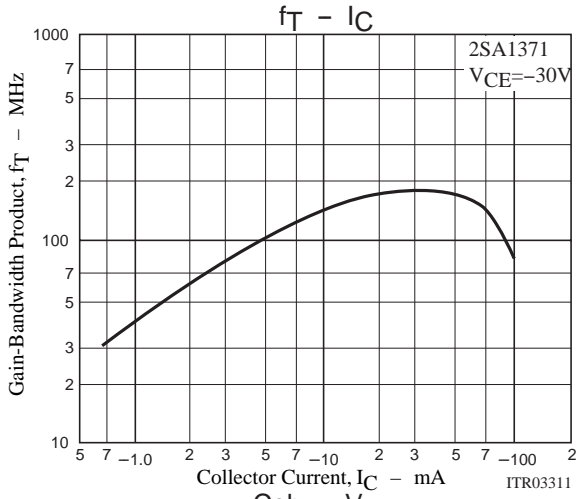

2SA1371/2SC3468

