

Rev.	Description	Date
A0	New release	2022.05.18

1. PHYSICAL CHARACTERISTICS (mm)

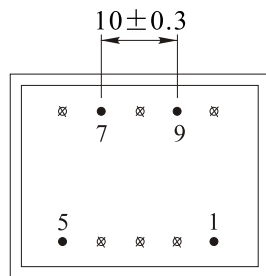
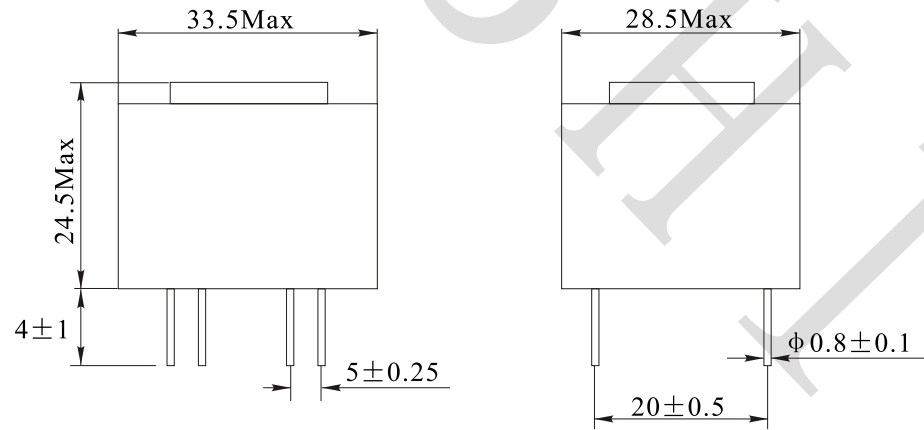

Bottom view

Top marking

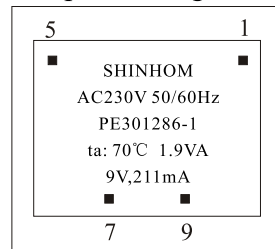

NOTES:

Temp 20°C 48%RH
RoHS Compliant

2. ELECTRONICAL SCHEMATIC

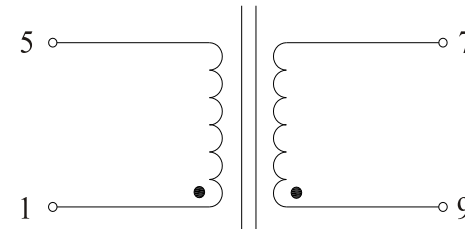

3. ELECTRONICAL SPECIFICATIONS

Pri voltage: 230V, 50Hz

Sec load voltage: 9.0V ± 0.5V @ 211mA

Noload voltage: 13.5V ± 0.5V

Output Power: 1.9VA

Hi-Pot: 4000V, 50Hz, 1mA, 10S Pri to Sec

Note:

- Solderability: leads shall meet MIL-STD-202, Method 208D for solderability.
- Flammability: UL94V-0
- ASTM oxygen index: >28%

NAME:	Potting Transformer		
CUSTOMER P/N:	BV EI 303 2031	DATE:	2022-05-18
SHINHOM P/N:	PE301286-1	REV: A0	PAGE
DRAWN BY	CHECKED BY	APPROVE BY	



SHINHOM
SHAANXISHINHOM ENTERPRISE CO LTD

The Document property belong to SHINHOM & is not allowed to be duplicated without authorization