

High voltage fast switching NPN power transistor

Datasheet — production data

Features

- High voltage capability
- Fast switching speed

Applications

- Lighting
- Switch mode power supply

Description

This device is a high voltage fast-switching NPN power transistor. It is manufactured using high voltage multi epitaxial planar technology for high switching speeds and medium voltage capability. It uses a cellular emitter structure with planar edge termination to enhance switching speeds while maintaining a wide RBSOA. The device is designed for use in lighting applications and low cost switch-mode power supplies.

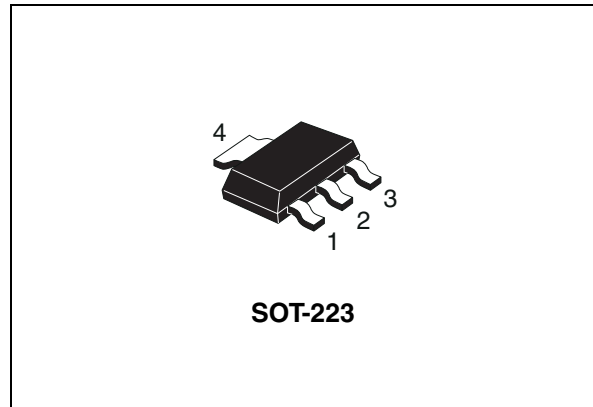

Figure 1. Internal schematic diagram

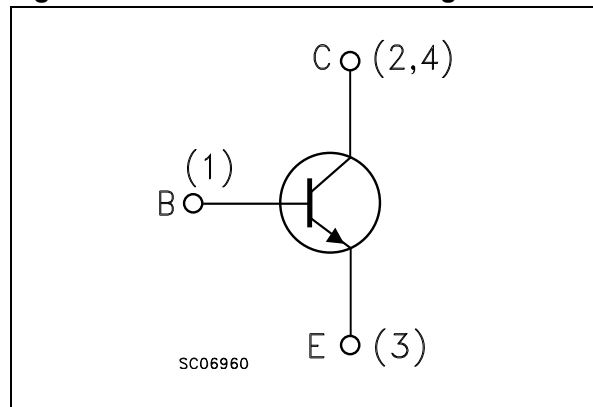

Table 1. Device summary

Order codes	Marking	Package	Packaging
STN2580	N2580	SOT-223	Tape and reel

1 Electrical ratings

Table 2. Absolute maximum ratings

Symbol	Parameter	Value	Unit
V_{CES}	Collector-emitter voltage ($V_{BE} = 0$)	800	V
V_{CEO}	Collector-emitter voltage ($I_B = 0$)	400	V
V_{EBO}	Emitter-base voltage ($I_C = 0$)	9	V
I_C	Collector current	1	A
I_{CM}	Collector peak current ($t_P < 5$ ms)	2	A
I_B	Base current	0.5	A
P_{TOT}	Total dissipation at $T_{amb} = 25$ °C	1.6	W
T_{STG}	Storage temperature	-65 to 150	°C
T_J	Max. operating junction temperature	150	°C

Table 3. Thermal data

Symbol	Parameter	Value	Unit
R_{thJA}	Thermal resistance junction-ambient max ⁽¹⁾	78	°C/W

1. When mounted on PCB area of 1cm²

2 Electrical characteristics

$T_{\text{case}} = 25\text{ }^{\circ}\text{C}$ unless otherwise specified.

Table 4. Electrical characteristics

Symbol	Parameter	Test conditions	Min.	Typ.	Max.	Unit
I_{CBO}	Collector cut-off current ($I_{\text{E}} = 0$)	$V_{\text{CB}} = 800\text{ V}$			10	μA
I_{EBO}	Emitter cut-off current ($I_{\text{C}} = 0$)	$V_{\text{EB}} = 8\text{ V}$			100	μA
$V_{(\text{BR})\text{CEO}}^{(1)}$	Collector-emitter breakdown voltage ($I_{\text{B}} = 0$)	$I_{\text{C}} = 10\text{ mA}$	400			V
$V_{(\text{BR})\text{EBO}}$	Emitter-base breakdown voltage ($I_{\text{C}} = 0$)	$I_{\text{E}} = 100\text{ }\mu\text{A}$	9			V
$h_{\text{FE}}^{(1)}$	DC current gain	$I_{\text{C}} = 250\text{ mA}$ $V_{\text{CE}} = 5\text{ V}$	60	100		
$V_{\text{CE}(\text{sat})}^{(1)}$	Collector-emitter saturation voltage	$I_{\text{C}} = 1\text{ A}$ $I_{\text{B}} = 0.2\text{ A}$			1	V
$V_{\text{BE}(\text{sat})}^{(1)}$	Base-emitter saturation voltage	$I_{\text{C}} = 1\text{ A}$ $I_{\text{B}} = 0.2\text{ A}$			1.1	V
t_{r}	Resistive load Rise time	$V_{\text{CC}}=200\text{ V}$, $I_{\text{C}}=0.3\text{ A}$		140		ns
t_{s}	Storage time	$I_{\text{B}1}=20\text{ mA}$, $I_{\text{B}2}=-50\text{ mA}$		4		μs
t_{f}	Fall time	$T_{\text{p}}=30\text{ }\mu\text{s}$		90		ns

1. Pulse test: pulse duration $\leq 300\text{ }\mu\text{s}$, duty cycle $\leq 2\%$

2.1 Electrical characteristics (curves)

Figure 2. Safe operating area

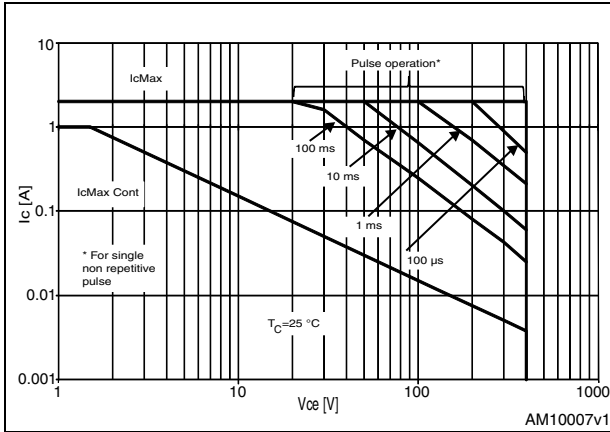

Figure 3. Derating curve

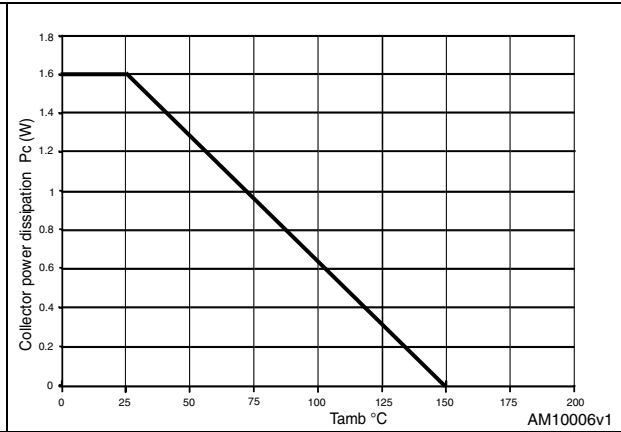

Figure 4. Output curves up to $V_{CE}=2 V$

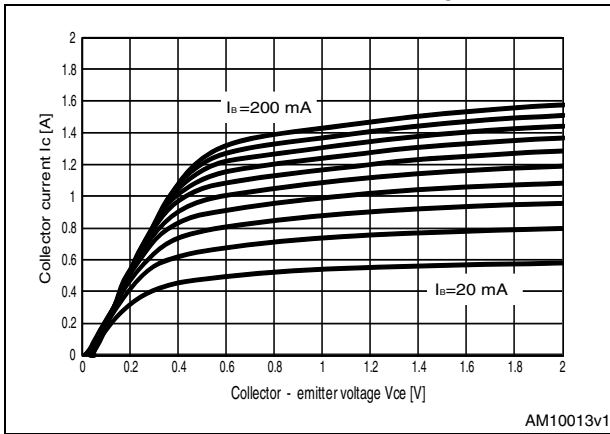

Figure 5. Output curves up to $V_{CE}=10 V$

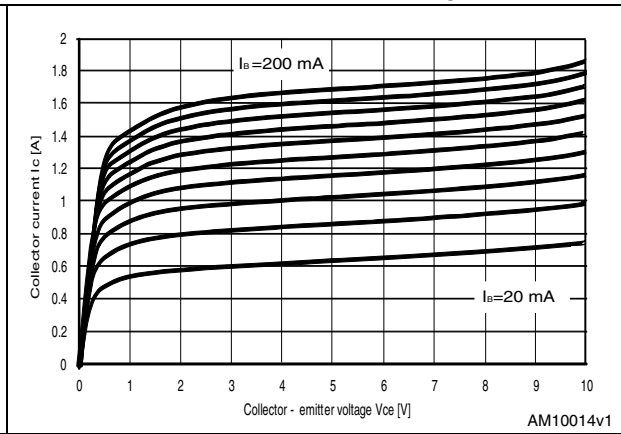

Figure 6. DC current gain ($V_{CE} = 1 V$)

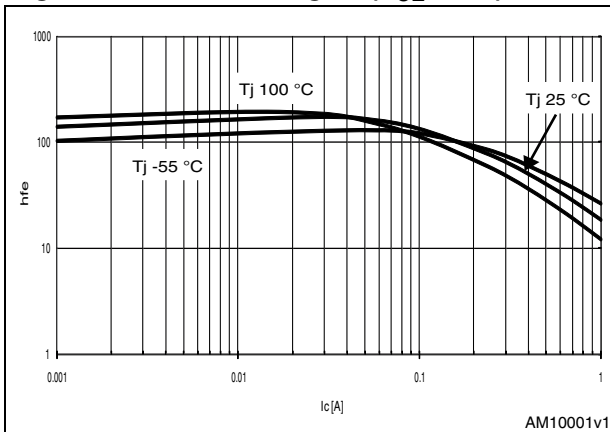

Figure 7. DC current gain ($V_{CE} = 5 V$)

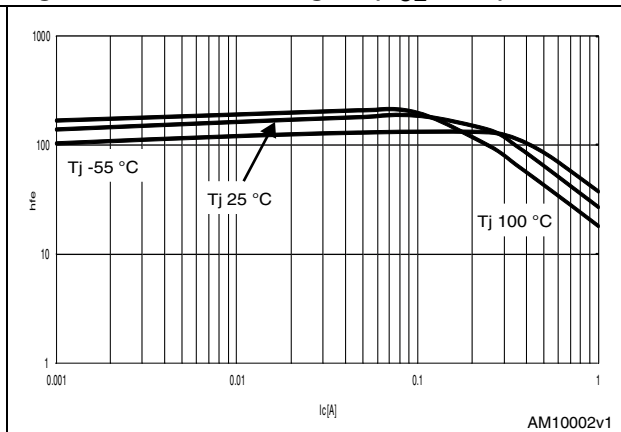

Figure 8. Collector-emitter saturation voltage Figure 9. Base-emitter saturation voltage

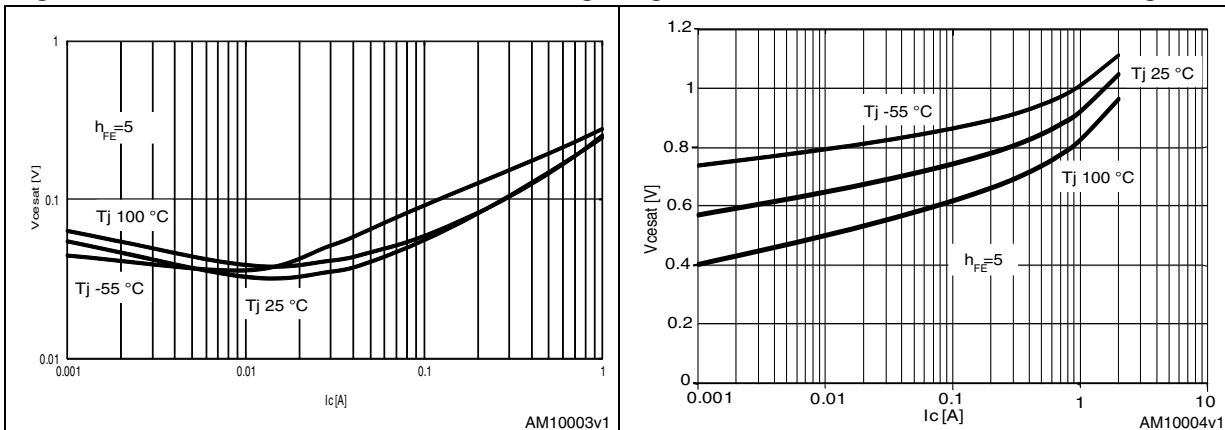

Figure 10. Base-emitter on voltage Figure 11. Capacitance variation

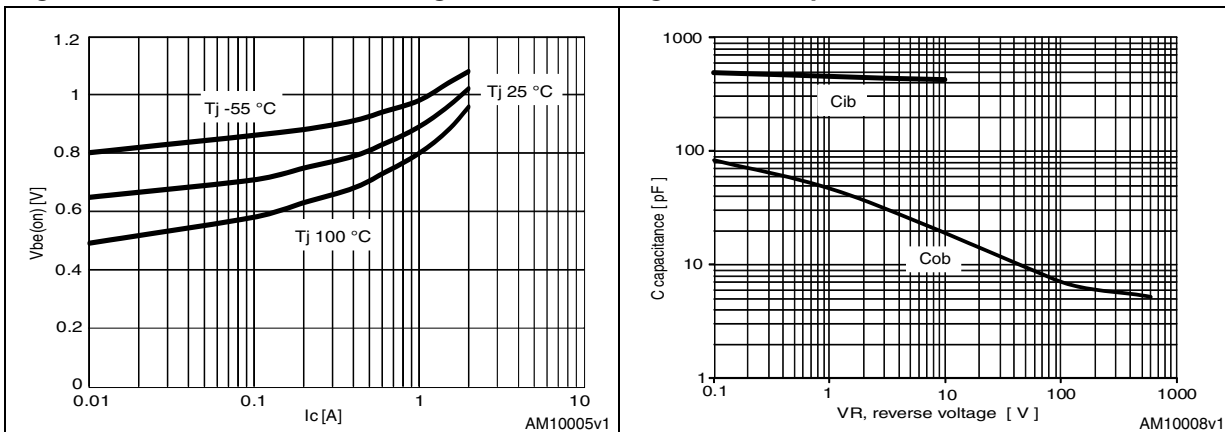

Figure 12. Resistive switching time Figure 13. $V_{be(sat)}$ vs. I_c

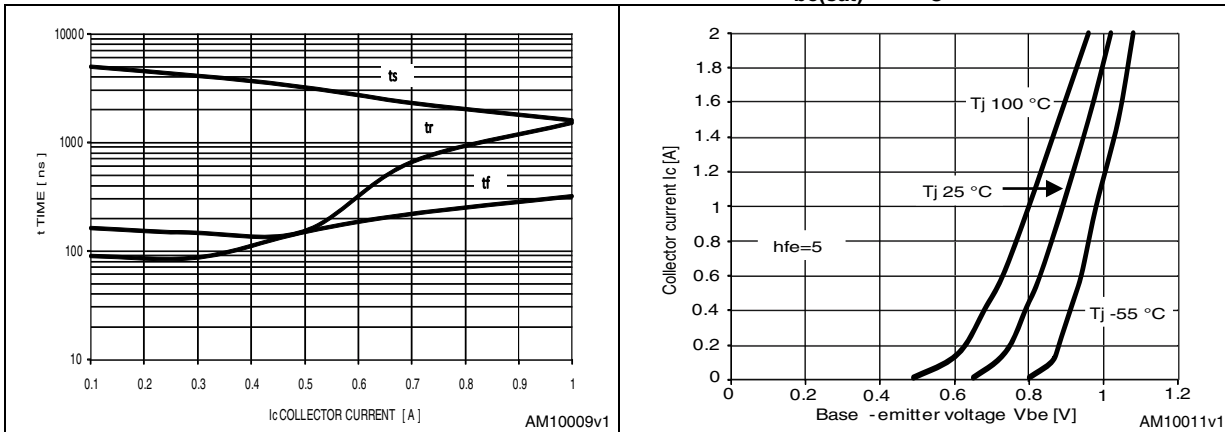
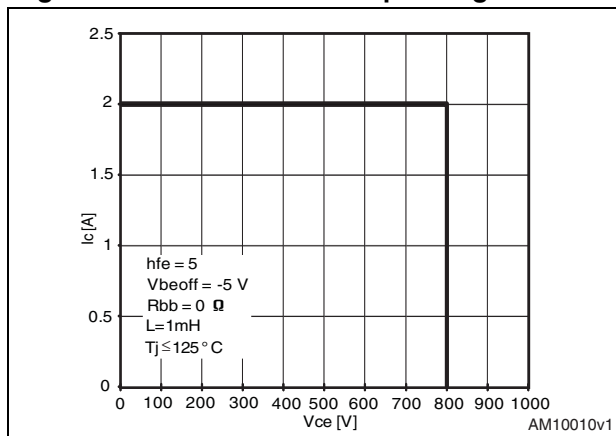
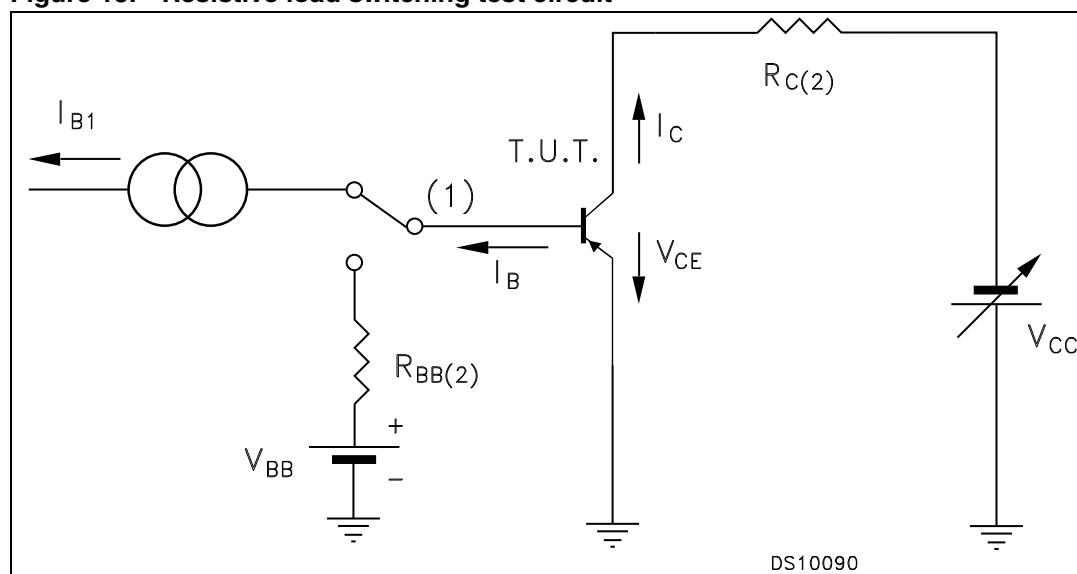

Figure 14. Reverse biased operating area



3 Test circuit

Figure 15. Resistive load switching test circuit



1. Fast electronic switching
2. Non-inductive resistor

Table 5. SOT-223 mechanical data

Dim.	mm		
	Min.	Typ.	Max.
A			1.80
A1	0.02		0.1
B	0.60	0.70	0.85
B1	2.90	3.00	3.15
c	0.24	0.26	0.35
D	6.30	6.50	6.70
e		2.30	
e1		4.60	
E	3.30	3.50	3.70
H	6.70	7.00	7.30
V			10°

Figure 16. SOT-223 mechanical data drawing

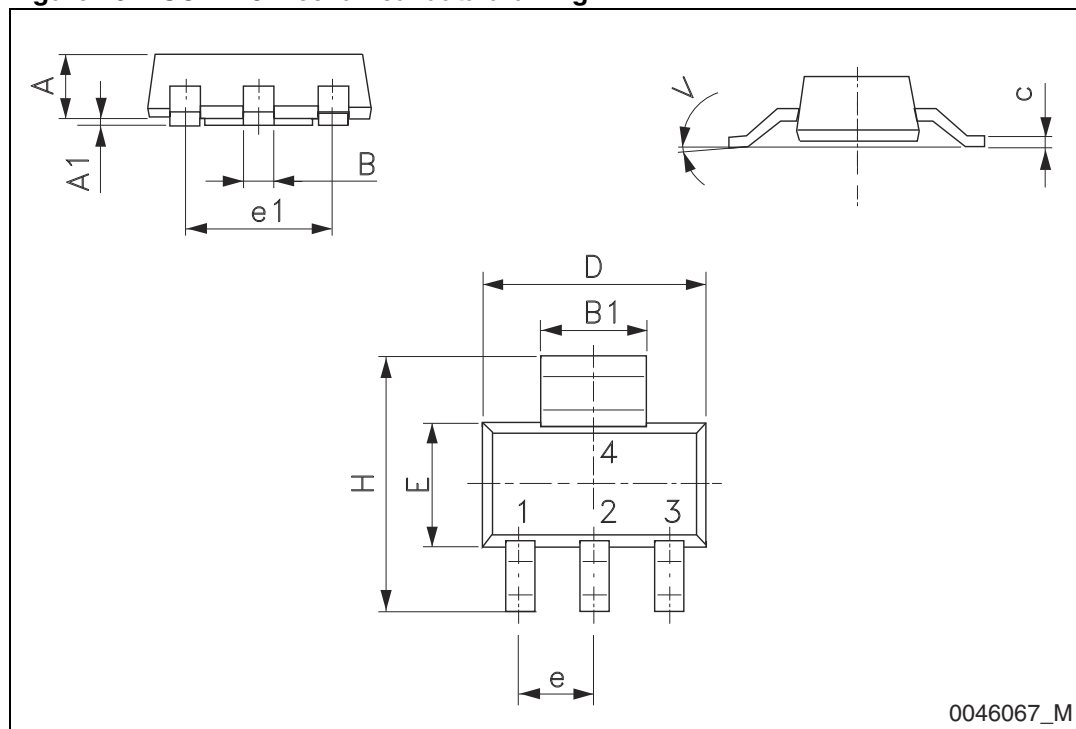

0046067_M

Figure 17. SOT-223 footprint (dimensions are in mm)

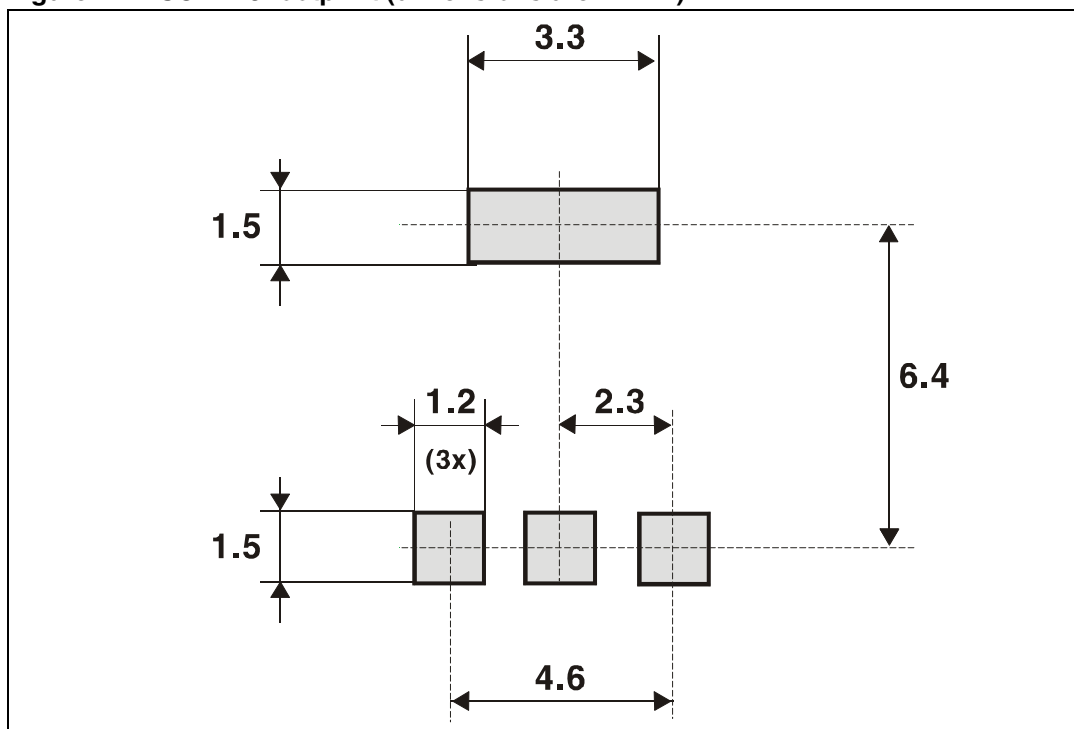

5 Packaging mechanical data

Table 6. SOT-223 tape and reel mechanical data

Tape				Reel		
Dim.	mm			Dim.	mm	
	Min.	Typ.	Max.		Min.	Max.
A0	6.75	6.85	6.95	A		180
B0	7.30	7.40	7.50	N	60	
K0	1.80	1.90	2.00	W1		12.4
F	5.40	5.50	5.60	W2		18.4
E	1.65	1.75	1.85	W3	11.9	15.4
W	11.7	12	12.3			
P2	1.90	2	2.10	Base quantity pcs		1000
P0	3.90	4	4.10	Bulk quantity pcs		1000
P1	7.90	8	8.10			
T	0.25	0.30	0.35			
D ϕ	1.50	1.55	1.60			
D1 ϕ	1.50	1.60	1.70			

Figure 18. Tape for SOT-223

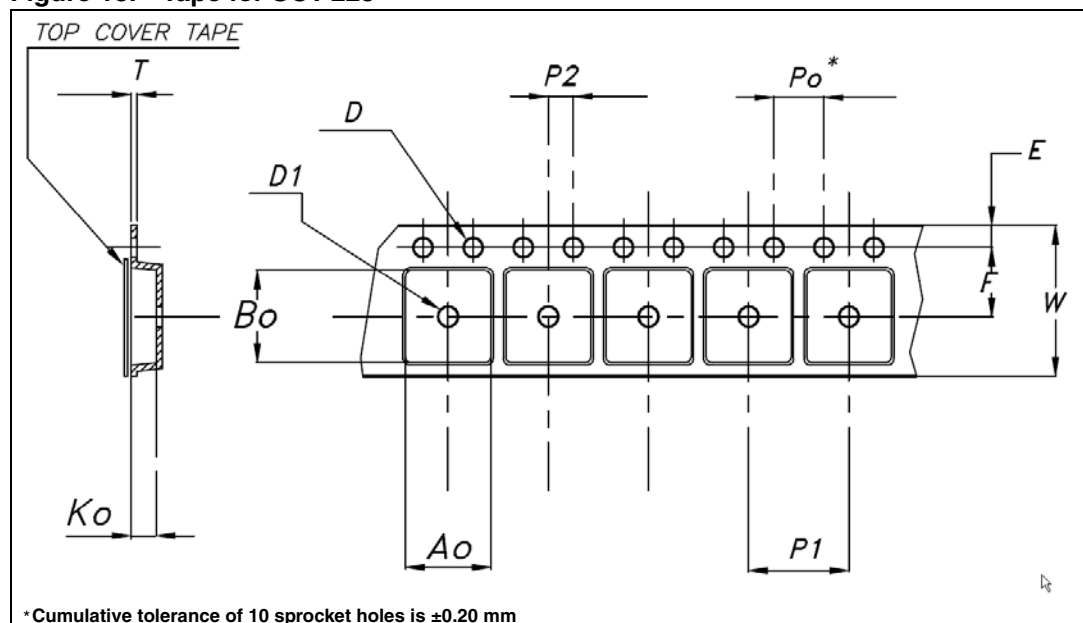

Figure 19. Reel for SOT-223 (dimensions are in mm)

