

## 800 V and 600 V, 25 A standard and Snubberless Triacs

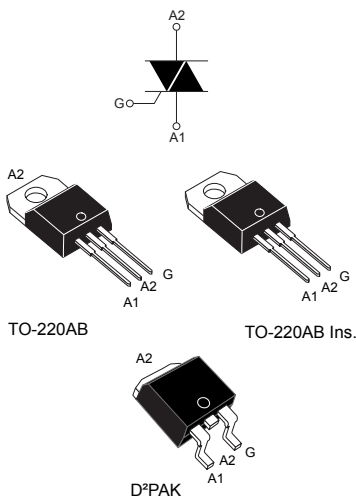

## Features

- High current 25 A RMS current Triac
- Low thermal resistance
- High commutation (4 quadrants) or very high commutation (3 quadrants) capability
- BTA series UL1557 recognized components (file ref: 81734)
- RoHS (2002/95/EC) compliant packages
- UL-94, V0 flammability package resin compliance

## Applications

- On/off function in static relays, heating regulation, induction motor starting circuits
- Phase control operations in light dimmers and motor speed controllers

## Description

Available either in through-hole or surface-mount packages, the BTA24, BTB24 and T25 are suitable for general purpose AC switching.



## Product status link

BTA24	TO-220AB insulated package
BTB24	TO-220AB un-insulated package
T25	D <sup>2</sup> PAK package

## Product summary

	BTA24	BTB24	T25
$I_{T(RMS)}$	25 A		
$V_{DRM}/V_{RRM}$	600 V and 800 V		
$I_{GT}$ Snubberless	35 / 50 mA	35 mA	
$I_{GT}$ standard		50 mA	

# 1 Characteristics

**Table 1. Absolute maximum ratings**

Symbol	Parameters		Value	Unit		
$I_{T(RMS)}$	RMS on-state current (full sine wave)	D <sup>2</sup> PAK / TO-220AB	$T_c = 100\text{ °C}$	25	A	
		TO-220AB Ins.	$T_c = 75\text{ °C}$			
$I_{TSM}$	Non repetitive surge peak on-state current (full cycle, $T_j$ initial = 25 °C)	f = 60 Hz	$t_p = 16,7\text{ ms}$	260	A	
		f = 50 Hz	$t_p = 20\text{ ms}$	250		
$I^2t$	$I^2t$ value for fusing	$t_p = 10\text{ ms}$		340	A <sup>2</sup> s	
di/dt	Critical rate of rise of on-state current $I_G = 2 \times I_{GT}$ , $t_r \leq 100\text{ ns}$	f = 120 Hz	$T_j = 125\text{ °C}$	50	A/ $\mu$ s	
$V_{DSM}, V_{RSM}$	Non repetitive surge peak off-state voltage	$t_p = 10\text{ ms}$	$T_j = 25\text{ °C}$	$V_{DRM}, V_{RRM} + 100$	V	
$V_{DRM}, V_{RRM}$	Repetitive peak off-state voltage	$T_j = 25\text{ °C}$		600 or 800	V	
$I_{GM}$	Peak gate current	$t_p = 20\text{ }\mu\text{s}$	$T_j = 125\text{ °C}$	4	A	
$P_{G(AV)}$	Average gate power dissipation	$T_j = 125\text{ °C}$		1	W	
$T_{stg}$	Storage junction temperature range				-40 to +150	°C
$T_j$	Operating junction temperature range				-40 to +125	°C
$T_L$	Maximum lead temperature for soldering during 10 s				260	°C
$V_{INS}$	Insulation RMS voltage, 1 minute				2.5	kV

**Table 2. Electrical characteristics ( $T_j = 25\text{ °C}$ , unless otherwise specified) - Snubberless (3 quadrants) T25, BTA24-XXXXW, BTB24-XXXXW**

Symbol	Parameters	Quadrant		T25	BTA/BTB		Unit
				T2535	CW	BW	
$I_{GT}^{(1)}$	$V_D = 12\text{ V}, R_L = 33\text{ }\Omega$	I - II - III	Max.	35	35	50	mA
$V_{GT}$		I - II - III	Max.	1.3		V	
$V_{GD}$	$V_D = V_{DRM}, R_L = 3.3\text{ k}\Omega, T_j = 125\text{ °C}$	I - II - III	Min.	0.2		V	
$I_H^{(2)}$	$I_T = 500\text{ mA}$		Max.	50	50	75	mA
$I_L$	$I_G = 1.2 I_{GT}$	I - III	Max.	70	70	80	
		II	Max.	80	80	100	
dV/dt <sup>(2)</sup>	$V_D = 67\% V_{DRM}$ gate open, $T_j = 125\text{ °C}$		Min.	500	500	1000	V/ $\mu$ s
(di/dt) <sup>(2)</sup>	Without snubber		Min.	13	13	22	A/ms

1. Minimum  $I_{GT}$  is guaranteed at 5 % of  $I_{GT}$  max.

2. For both polarities of A2 referenced to A1

**Table 3. Electrical characteristics ( $T_j = 25\text{ }^\circ\text{C}$ , unless otherwise specified) - standard (4 quadrants)  
 BTB24-800B, BTB24-600B**

Symbol	Parameters	Quadrant		Value	Unit
$I_{GT}^{(1)}$	$V_D = 12\text{ V}, R_L = 33\ \Omega$	I - II - III	Max.	50	mA
		IV		100	
$V_{GT}$		All	Max.	1.3	V
$V_{GD}$	$V_D = V_{DRM}, R_L = 3.3\text{ k}\Omega, T_j = 125\text{ }^\circ\text{C}$	All	Min.	0.2	V
$I_H^{(2)}$	$I_T = 500\text{ mA}$		Max.	80	mA
$I_L$	$I_G = 1.2\ I_{GT}$	I - III - IV	Max.	70	mA
		II	Max.	160	
$dV/dt^{(2)}$	$V_D = 67\% V_{DRM}$ gate open, $T_j = 125\text{ }^\circ\text{C}$		Min.	500	V/ $\mu\text{s}$
$(dI/dt)_c^{(2)}$	$(dI/dt)_c = 13.3\text{ A/ms}, T_j = 125\text{ }^\circ\text{C}$		Min.	10	V/ $\mu\text{s}$

1. Minimum  $I_{GT}$  is guaranteed at 5 % of  $I_{GT}$  max.
2. For both polarities of A2 referenced to A1

**Table 4. Static electrical characteristics**

Symbol	Test conditions	$T_j$		Value	Unit
$V_{TM}^{(1)}$	$I_{TM} = 35\text{ A}, t_p = 380\ \mu\text{s}$	$25\text{ }^\circ\text{C}$	Max.	1.55	V
$V_{TO}^{(1)}$	threshold on-state voltage	$125\text{ }^\circ\text{C}$	Max.	0.85	V
$R_D^{(1)}$	Dynamic resistance	$125\text{ }^\circ\text{C}$	Max.	16	m $\Omega$
$I_{DRM}/I_{RRM}$	$V_T = V_{DRM}, V_T = V_{RRM}$	$25\text{ }^\circ\text{C}$	Max.	5	$\mu\text{A}$
		$125\text{ }^\circ\text{C}$		3	mA

1. For both polarities of A2 referenced to A1

**Table 5. Thermal resistance**

Symbol	Parameters			Value	Unit
$R_{th(j-c)}$	Junction to case (AC)	D <sup>2</sup> PAK / TO-220AB	Max.	0.8	$^\circ\text{C/W}$
		TO-220AB insulated		1.7	
$R_{th(j-a)}$	Junction to ambient, $S^{(1)} = 2.5\text{ cm}^2$	D <sup>2</sup> PAK	Typ.	45	
	Junction to ambient	TO-220AB / TO-220AB insulated		60	

1.  $S$  = Copper surface under tab.

### 1.1 Characteristics (curves)

**Figure 1. Maximum power dissipation versus on-state RMS current (full cycle)**

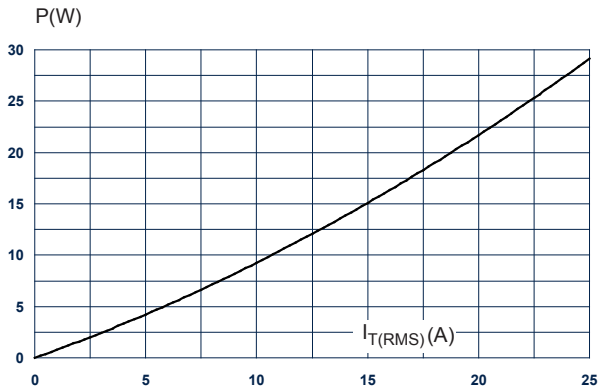

**Figure 2. RMS on-state current versus case temperature (full cycle)**

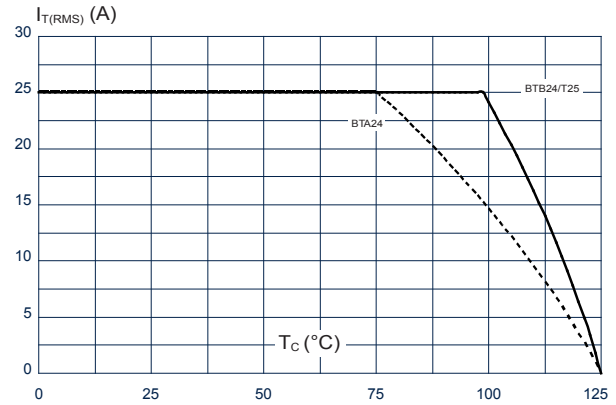

**Figure 3. RMS on-state current versus ambient temperature (full cycle) D<sup>2</sup>PAK**

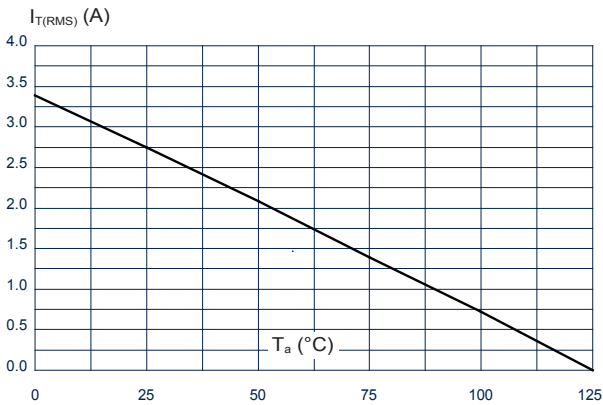

**Figure 4. Relative variation of thermal impedance versus pulse duration**

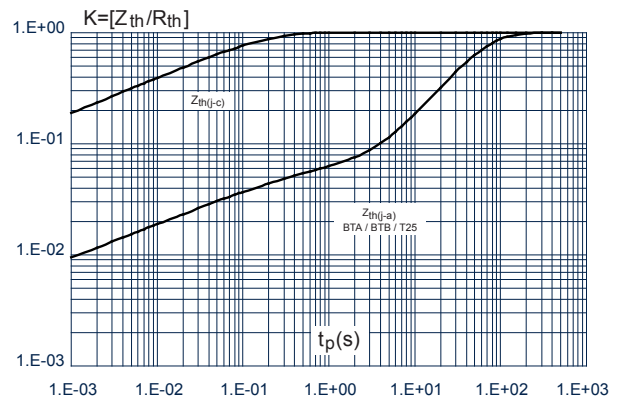

**Figure 5. On-state characteristics (maximum values)**

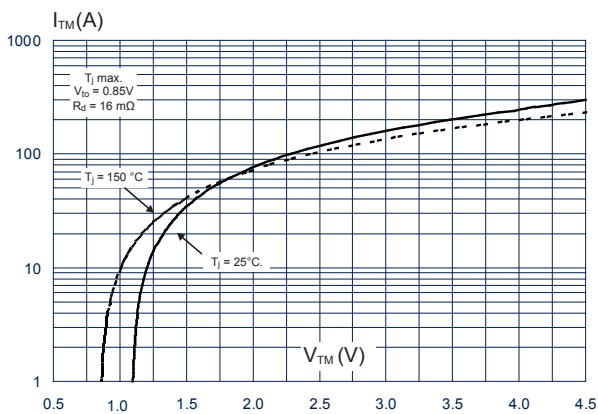

**Figure 6. Surge peak on-state current versus number of cycles**

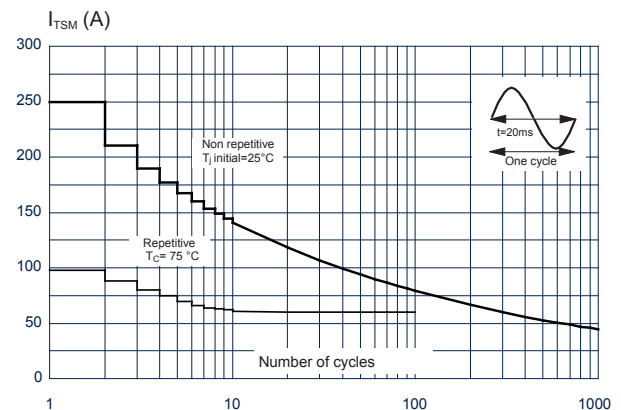

**Figure 7. Non-repetitive surge peak on-state current for a sinusoidal pulse with width  $t_p < 10$  ms**

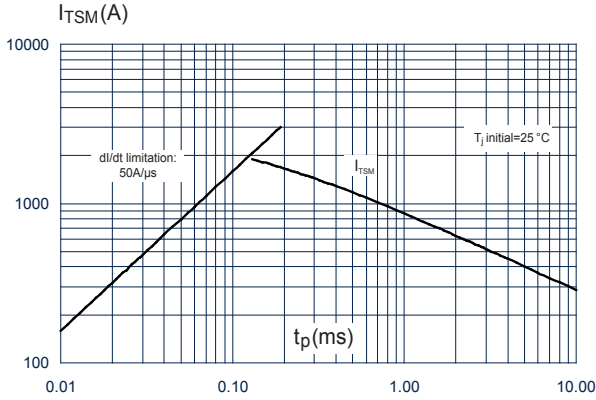

**Figure 8. Relative variation of gate trigger current, holding and latching current versus junction temperature**

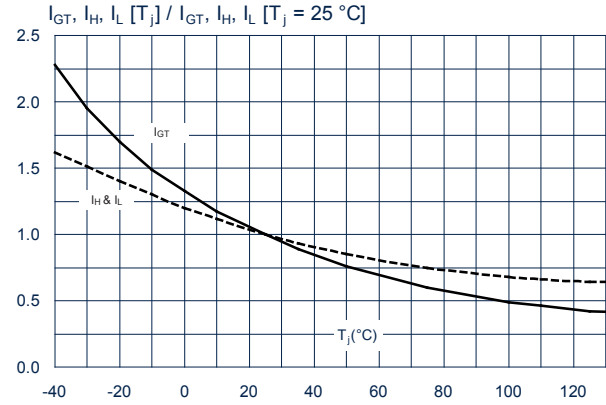

**Figure 9. Relative variation of critical rate of decrease of main current versus (dV/dt)c (typical values)**

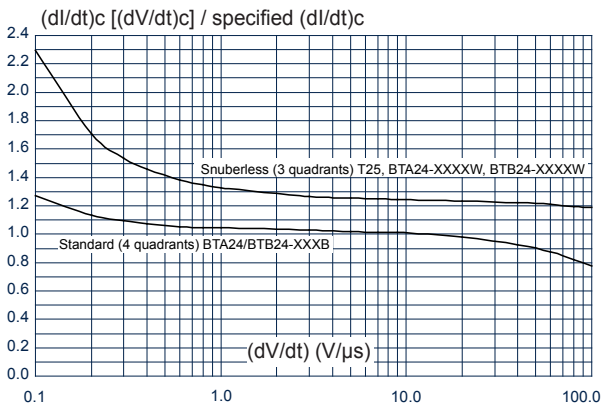

**Figure 10. Relative variation of critical rate of decrease of main current versus junction temperature (typical values)**

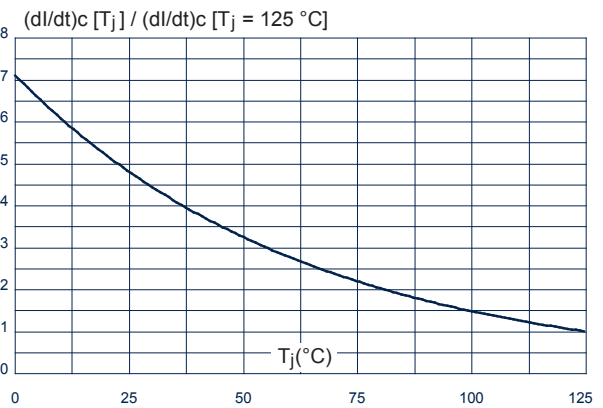

**Figure 11. D<sup>2</sup>PAK thermal resistance junction to ambient versus copper surface under tab**

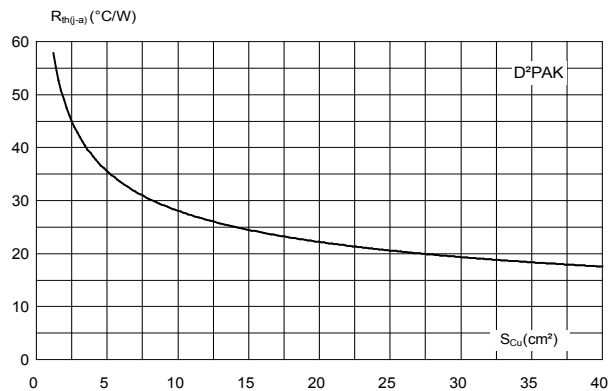

## 2 Package information

In order to meet environmental requirements, ST offers these devices in different grades of **ECOPACK** packages, depending on their level of environmental compliance. ECOPACK specifications, grade definitions and product status are available at: [www.st.com](http://www.st.com). ECOPACK is an ST trademark.

### 2.1 TO-220AB package information

- Molding compound resin is halogen free and meets UL94 flammability standard, level V0
- Lead-free plating package leads
- Recommended torque: 0.4 to 0.6 N·m

Figure 12. TO-220AB package outline

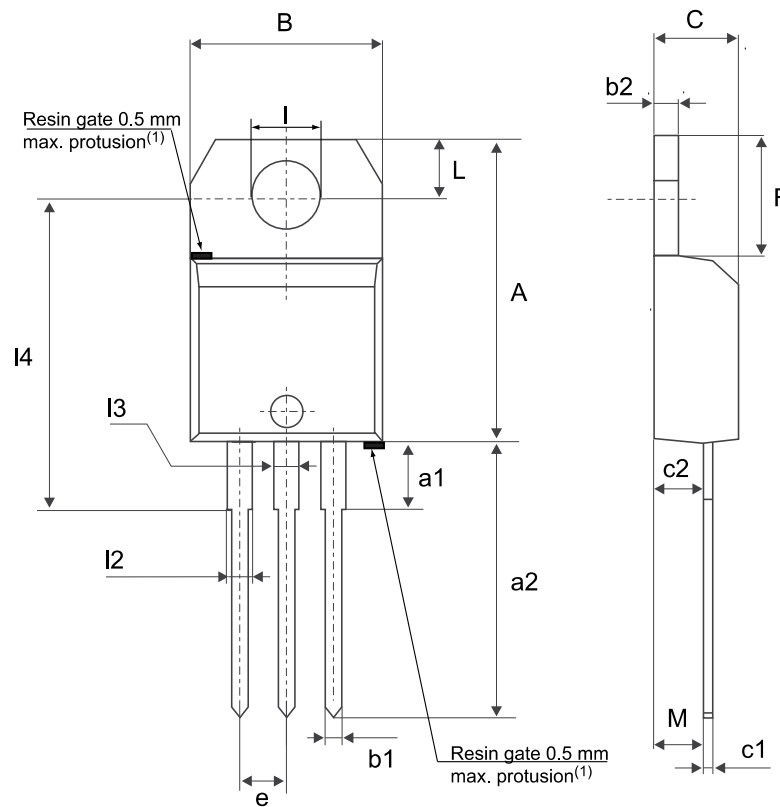

(1) Resin gate position accepted in one of the two positions or in the symmetrical opposites.

**Table 6. TO-220AB package mechanical data**

Ref.	Dimensions					
	Millimeters			Inches <sup>(1)</sup>		
	Min.	Typ.	Max.	Min.	Typ.	Max.
A	15.20		15.90	0.5984		0.6260
a1		3.75			0.1476	
a2	13.00		14.00	0.5118		0.5512
B	10.00		10.40	0.3937		0.4094
b1	0.61		0.88	0.0240		0.0346
b2	1.23		1.32	0.0484		0.0520
C	4.40		4.60	0.1732		0.1811
c1	0.49		0.70	0.0193		0.0276
c2	2.40		2.72	0.0945		0.1071
e	2.40		2.70	0.0945		0.1063
F	6.20		6.60	0.2441		0.2598
I	3.73		3.88	0.1469		0.1528
L	2.65		2.95	0.1043		0.1161
I2	1.14		1.70	0.0449		0.0669
I3	1.14		1.70	0.0449		0.0669
I4	15.80	16.40	16.80	0.6220	0.6457	0.6614
M		2.6			0.1024	

1. Inch dimensions are for reference only.

## 2.2 D<sup>2</sup>PAK package information

- ECOPACK2 compliant
- Lead-free package leads finishing
- Molding compound resin is halogen-free and meets UL94 flammability standard level V0

**Figure 13. D<sup>2</sup>PAK package outline**

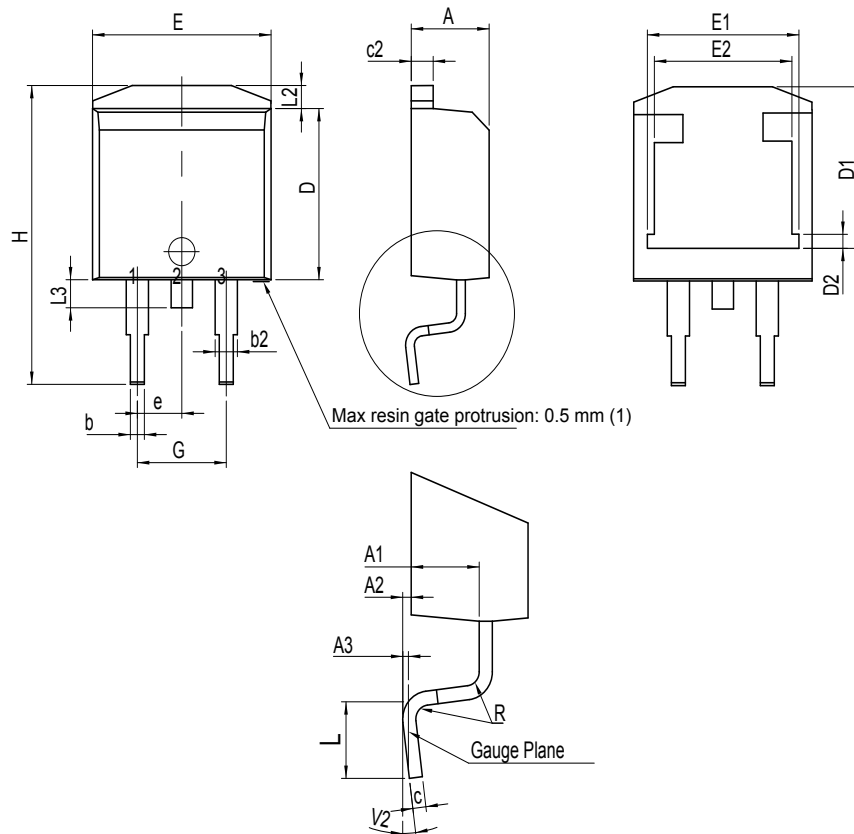

(1) Resin gate is accepted in each of position shown on the drawing, or their symmetrical.



**Table 7. D<sup>2</sup>PAK package mechanical data**

Ref.	Dimensions					
	Millimeters			Inches <sup>(1)</sup>		
	Min.	Typ.	Max.	Min.	Typ.	Max.
A	4.30		4.60	0.1693		0.1811
A1	2.49		2.69	0.0980		0.1059
A2	0.03		0.23	0.0012		0.0091
A3		0.25			0.0098	
b	0.70		0.93	0.0276		0.0366
b2	1.25		1.7	0.0492		0.0669
c	0.45		0.60	0.0177		0.0236
c2	1.21		1.36	0.0476		0.0535
D	8.95		9.35	0.3524		0.3681
D1	7.50		8.00	0.2953		0.3150
D2	1.30		1.70	0.0512		0.0669
e	2.54			0.10000		
E	10.00		10.28	0.3937		0.4047
E1	8.30		8.70	0.3268		0.3425
E2	6.85		7.25	0.2697		0.2854
G	4.88		5.28	0.1921		0.2079
H	15		15.85	0.5906		0.6240
L	1.78		2.28	0.0701		0.0898
L2	1.19		1.40	0.0468		0.0551
L3	1.40		1.75	0.0551		0.0689
R		0.40			0.0157	
V2 <sup>(2)</sup>	0°		8°	0°		8°

1. Dimensions in inches are given for reference only

2. Degrees

Figure 14. D<sup>2</sup>PAK recommended footprint (dimensions are in mm)

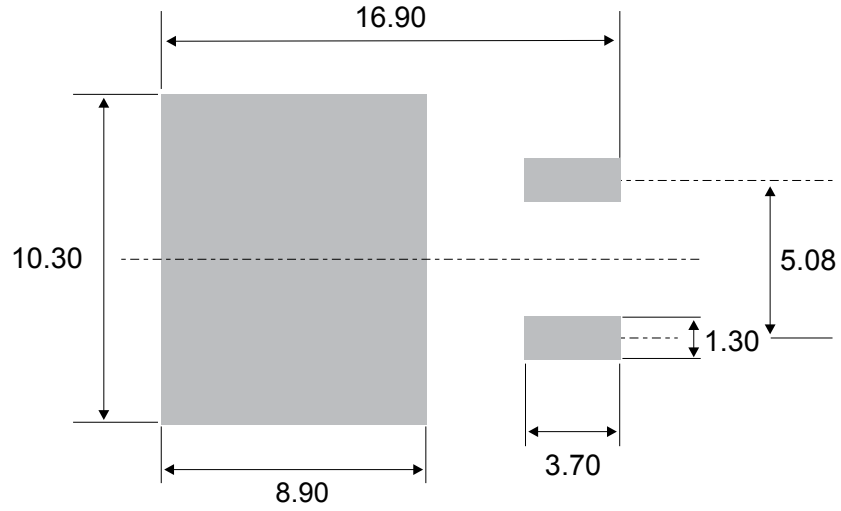
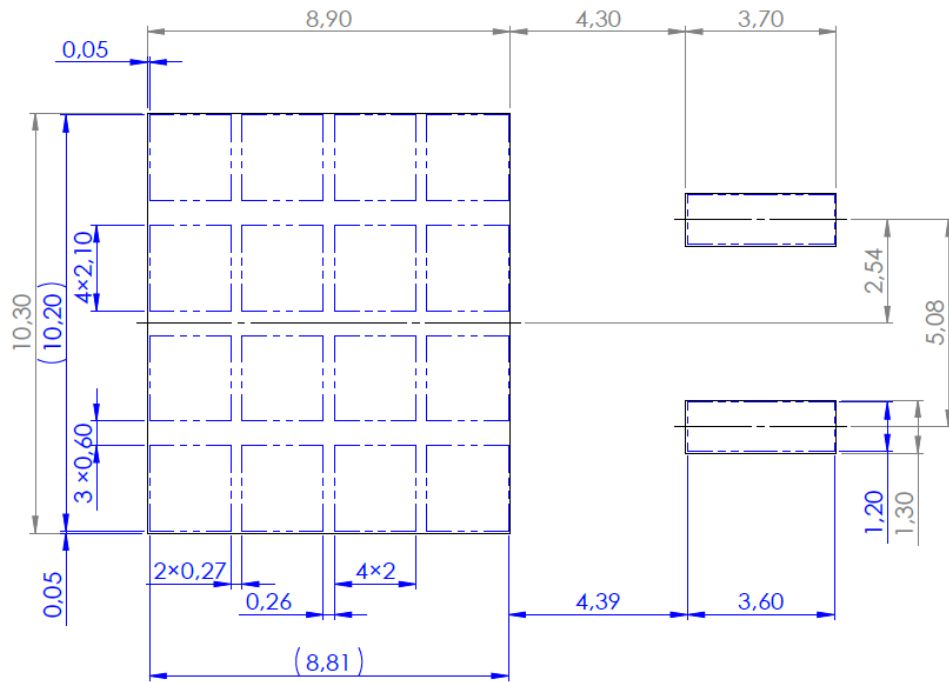

Figure 15. D<sup>2</sup>PAK stencil definitions (dimensions are in mm)



### 3 Ordering information

Figure 16. Ordering information scheme (BTA24 and BTB24 series)

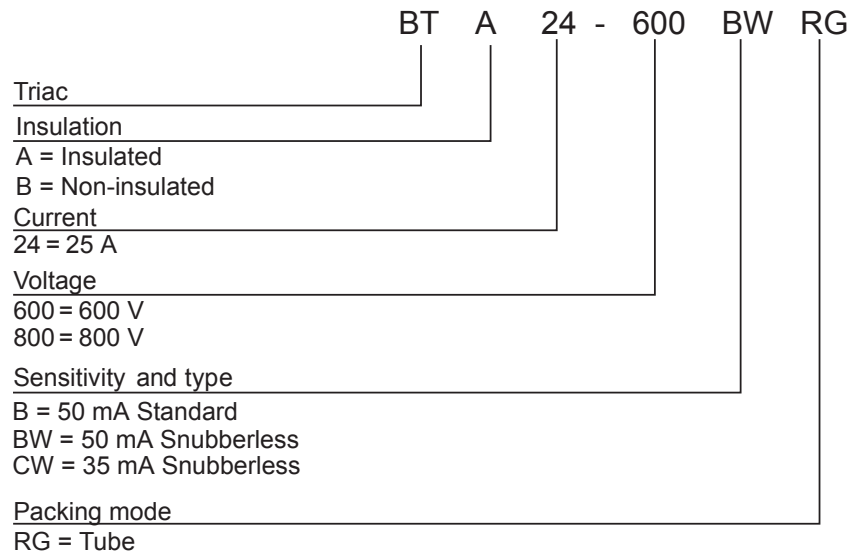
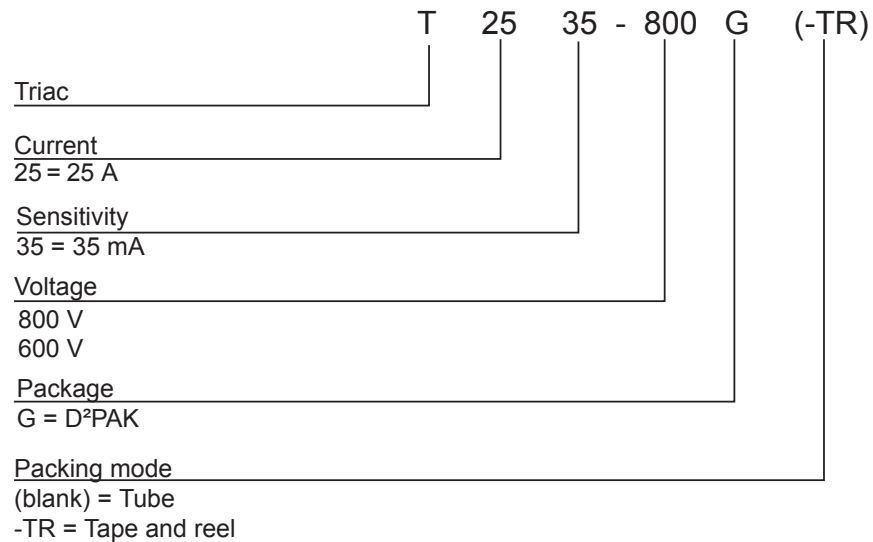

Figure 17. Ordering information scheme (T25 series)



**Table 8. Ordering information**

Order code	Marking	Package	Weight	Base qty.	Delivery mode
BTA24-600BWRG	BTA24 600BW	TO-220AB insulated	2.3 g	50	Tube
BTA24-600CWRG	BTA24 600CW				
BTA24-800BWRG	BTA24 800BW				
BTA24-800CWRG	BTA24 800CW				
BTB24-600BRG	BTB24 600B	TO-220AB			
BTB24-600BWRG	BTB24 600BW				
BTB24-600CWRG	BTB24 600CW				
BTB24-800BRG	BTB24 800B				
BTB24-800BWRG	BTB24 800BW				
BTB24-800CWRG	BTB24 800CW				
T2535-600G	T2535 600G	D <sup>2</sup> PAK	1.5 g	50	Tube
T2535-600G-TR	T2535 600G			2500	Tape and reel
T2535-800G	T2535 800G			50	Tube
T2535-800G-TR	T2535 800G			2500	Tape and reel

## Revision history

**Table 9. Document revision history**

Date	Revision	Changes
Oct-2002	6A	Previous update.
13-Feb-2006	7	TO-220AB delivery mode changed from bulk to tube. ECOPACK statement added.
31-May-2006	8	Reformatted to current standard. Tc in figure 3 changed to Tamb
31-Jul-2006	9	Typing error corrected on page 1 (BTB124 instead of BTB24)
05-Jul-2007	10	Added BTB26-600BRG. Restructured cover page and section 2: Ordering information scheme on page 6 to simplify product selection. Thermal resistance values updated in Table 6 and Figure 2. Graphic for I2t updated in Figure 7.
28-Jul-2021	11	Removed RD91, TOP3 insulated and TOP3 package information. Put in separate specification. Minor text changes.
29-Sep-2021	12	Updated <a href="#">Table 2</a> .