



# STGB19NC60KD STGF19NC60KD - STGP19NC60KD

20 A - 600 V - short circuit rugged IGBT

## Features

- Low on-voltage drop ( $V_{CE(sat)}$ )
- Low  $C_{res} / C_{ies}$  ratio (no cross conduction susceptibility)
- Short circuit withstand time 10  $\mu$ s
- IGBT co-packaged with ultra fast free-wheeling diode

## Applications

- High frequency inverters
- Motor drivers

## Description

This IGBT utilizes the advanced PowerMESH™ process resulting in an excellent trade-off between switching performance and low on-state behavior.

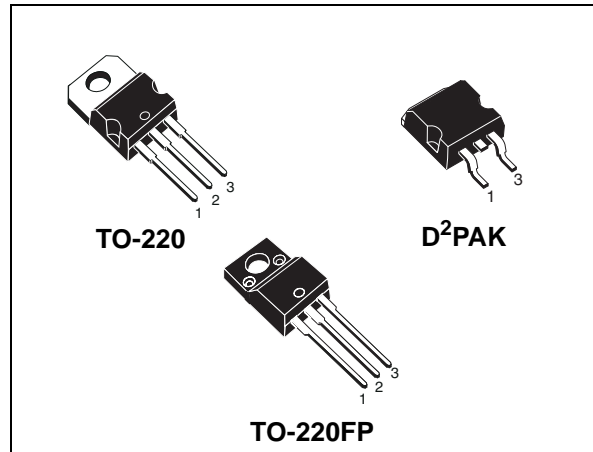

Figure 1. Internal schematic diagram



Table 1. Device summary

Order codes	Marking	Package	Packaging
STGB19NC60KDT4	GB19NC60KD	D <sup>2</sup> PAK	Tape and reel
STGF19NC60KD	GF19NC60KD	TO-220FP	Tube
STGP19NC60KD	GP19NC60KD	TO-220	Tube

# Contents

<b>1</b>	<b>Electrical ratings</b> .....	<b>3</b>
<b>2</b>	<b>Electrical characteristics</b> .....	<b>4</b>
2.1	Electrical characteristics (curves) .....	7
<b>3</b>	<b>Test circuits</b> .....	<b>10</b>
<b>4</b>	<b>Package mechanical data</b> .....	<b>11</b>
<b>5</b>	<b>Packing mechanical data</b> .....	<b>16</b>
<b>6</b>	<b>Revision history</b> .....	<b>17</b>

# 1 Electrical ratings

**Table 2. Absolute maximum ratings**

Symbol	Parameter	Value		Unit
		D <sup>2</sup> PAK TO-220	TO-220FP	
V <sub>CES</sub>	Collector-emitter voltage (V <sub>GE</sub> = 0)	600		V
I <sub>C</sub> <sup>(1)</sup>	Collector current (continuous) at T <sub>C</sub> = 25 °C	35	16	A
I <sub>C</sub> <sup>(1)</sup>	Collector current (continuous) at T <sub>C</sub> = 100 °C	20	10	A
I <sub>CL</sub> <sup>(2)</sup>	Turn-off latching current	75		A
I <sub>CP</sub> <sup>(3)</sup>	Pulsed collector current	75		A
V <sub>GE</sub>	Gate-emitter voltage	±20		V
I <sub>F</sub>	Diode RMS forward current at T <sub>C</sub> = 25 °C	20		A
I <sub>FSM</sub>	Surge non repetitive forward current t <sub>p</sub> = 10 ms sinusoidal	50		A
P <sub>TOT</sub>	Total dissipation at T <sub>C</sub> = 25 °C	125	32	W
t <sub>scw</sub>	Short circuit withstand time, V <sub>CE</sub> = 0.5 V <sub>(BR)CES</sub> T <sub>j</sub> = 125 °C, R <sub>G</sub> = 10 Ω, V <sub>GE</sub> = 12 V	10		µs
T <sub>j</sub>	Operating junction temperature	- 55 to 150		°C

1. Calculated according to the iterative formula:

$$I_c(T_c) = \frac{T_{J(MAX)} - T_c}{R_{thj-c} \times V_{CE(sat)(MAX)} \cdot (T_c, I_c)}$$

2. V<sub>clamp</sub> = 80%·(V<sub>CES</sub>), T<sub>j</sub> = 150°C, R<sub>G</sub> = 10 Ω, V<sub>GE</sub> = 15 V

3. Pulse width limited by max. junction temperature allowed

**Table 3. Thermal resistance**

Symbol	Parameter	Value		Unit
		D <sup>2</sup> PAK TO-220	TO-220FP	
R <sub>thj-case</sub>	Thermal resistance junction-case IGBT max.	0.95	3.9	°C/W
	Thermal resistance junction-case diode max.	3	5.6	°C/W
R <sub>thj-amb</sub>	Thermal resistance junction-ambient max.	62.5		°C/W

## 2 Electrical characteristics

( $T_{CASE} = 25\text{ °C}$  unless otherwise specified)

**Table 4. Static**

Symbol	Parameter	Test conditions	Min.	Typ.	Max.	Unit
$V_{(BR)CES}$	Collector-emitter breakdown voltage ( $V_{GE} = 0$ )	$I_C = 1\text{ mA}$	600			V
$V_{CE(sat)}$	Collector-emitter saturation voltage	$V_{GE} = 15\text{ V}, I_C = 12\text{ A}$		2.0	2.75	V
		$V_{GE} = 15\text{ V}, I_C = 12\text{ A}, T_C = 125\text{ °C}$		1.8		V
$I_{CES}$	Collector cut-off current ( $V_{GE} = 0$ )	$V_{CE} = 600\text{ V}$			150	$\mu\text{A}$
		$V_{CE} = 600\text{ V}, T_C = 125\text{ °C}$			1	$\text{mA}$
$V_{GE(th)}$	Gate threshold voltage	$V_{CE} = V_{GE}, I_C = 250\text{ }\mu\text{A}$	4.5		6.5	V
$I_{GES}$	Gate-emitter leakage current ( $V_{CE} = 0$ )	$V_{GE} = \pm 20\text{ V}$			$\pm 100$	$\text{nA}$
$g_{fs}^{(1)}$	Forward transconductance	$V_{CE} = 15\text{ V}, I_C = 12\text{ A}$		15		S

1. Pulsed: Pulse duration = 300  $\mu\text{s}$ , duty cycle 1.5%

**Table 5. Dynamic**

Symbol	Parameter	Test conditions	Min.	Typ.	Max.	Unit
$C_{ies}$	Input capacitance	$V_{CE} = 25\text{ V}, f = 1\text{ MHz}, V_{GE} = 0$		1170		$\text{pF}$
$C_{oes}$	Output capacitance			127		$\text{pF}$
$C_{res}$	Reverse transfer capacitance			28		$\text{pF}$
$Q_g$	Total gate charge	$V_{CE} = 480\text{ V}, I_C = 12\text{ A},$		55		$\text{nC}$
$Q_{ge}$	Gate-emitter charge	$V_{GE} = 15\text{ V}$		11		$\text{nC}$
$Q_{gc}$	Gate-collector charge	(see Figure 19)		26		$\text{nC}$

**Table 6. Switching on/off (inductive load)**

Symbol	Parameter	Test conditions	Min.	Typ.	Max.	Unit
$t_{d(on)}$ $t_r$ $(di/dt)_{on}$	Turn-on delay time Current rise time Turn-on current slope	$V_{CC} = 480\text{ V}$ , $I_C = 12\text{ A}$ $R_G = 10\ \Omega$ , $V_{GE} = 15\text{ V}$ , (see Figure 18)		30 8 1450		ns ns A/ $\mu$ s
$t_{d(on)}$ $t_r$ $(di/dt)_{on}$	Turn-on delay time Current rise time Turn-on current slope	$V_{CC} = 480\text{ V}$ , $I_C = 12\text{ A}$ $R_G = 10\ \Omega$ , $V_{GE} = 15\text{ V}$ , $T_C = 125\text{ }^\circ\text{C}$ (see Figure 18)		30 8 1380		ns ns A/ $\mu$ s
$t_r(V_{off})$ $t_{d(off)}$ $t_f$	Off voltage rise time Turn-off delay time Current fall time	$V_{CC} = 480\text{ V}$ , $I_C = 12\text{ A}$ $R_G = 10\ \Omega$ , $V_{GE} = 15\text{ V}$ , (see Figure 18)		35 105 85		ns ns ns
$t_r(V_{off})$ $t_{d(off)}$ $t_f$	Off voltage rise time Turn-off delay time Current fall time	$V_{CC} = 480\text{ V}$ , $I_C = 12\text{ A}$ , $R_G = 10\ \Omega$ , $V_{GE} = 15\text{ V}$ $T_C = 125\text{ }^\circ\text{C}$ (see Figure 18)		65 145 125		ns ns ns

**Table 7. Switching energy (inductive load)**

Symbol	Parameter	Test conditions	Min	Typ.	Max	Unit
$E_{on}$ $E_{off}^{(1)}$ $E_{ts}$	Turn-on switching losses Turn-off switching losses Total switching losses	$V_{CC} = 480\text{ V}$ , $I_C = 12\text{ A}$ $R_G = 10\ \Omega$ , $V_{GE} = 15\text{ V}$ , (see Figure 18)		165 255 420		$\mu$ J $\mu$ J $\mu$ J
$E_{on}$ $E_{off}^{(1)}$ $E_{ts}$	Turn-on switching losses Turn-off switching losses Total switching losses	$V_{CC} = 480\text{ V}$ , $I_C = 12\text{ A}$ $R_G = 10\ \Omega$ , $V_{GE} = 15\text{ V}$ , $T_C = 125\text{ }^\circ\text{C}$ (see Figure 18)		250 445 695		$\mu$ J $\mu$ J $\mu$ J

1. Turn-off losses include also the tail of the collector current.

Table 8. Collector-emitter diode

Symbol	Parameter	Test conditions	Min.	Typ.	Max.	Unit
$V_F$	Forward on-voltage	$I_F = 12 \text{ A}$		1.9		V
		$I_F = 12 \text{ A}, T_C = 125 \text{ }^\circ\text{C}$		1.6		V
$t_{rr}$	Reverse recovery time	$I_F = 12 \text{ A}, V_R = 40 \text{ V},$ $di/dt = 100 \text{ A}/\mu\text{s}$		31		ns
$Q_{rr}$	Reverse recovery charge	$di/dt = 100 \text{ A}/\mu\text{s}$		30		nC
$I_{rrm}$	Reverse recovery current	(see Figure 21)		2		A
$t_{rr}$	Reverse recovery time	$I_F = 12 \text{ A}, V_R = 40 \text{ V},$ $T_C = 125 \text{ }^\circ\text{C}, di/dt = 100 \text{ A}/\mu\text{s}$		50		ns
$Q_{rr}$	Reverse recovery charge	$T_C = 125 \text{ }^\circ\text{C}, di/dt = 100 \text{ A}/\mu\text{s}$		70		nC
$I_{rrm}$	Reverse recovery current	(see Figure 21)		4		A

## 2.1 Electrical characteristics (curves)

Figure 2. Output characteristics

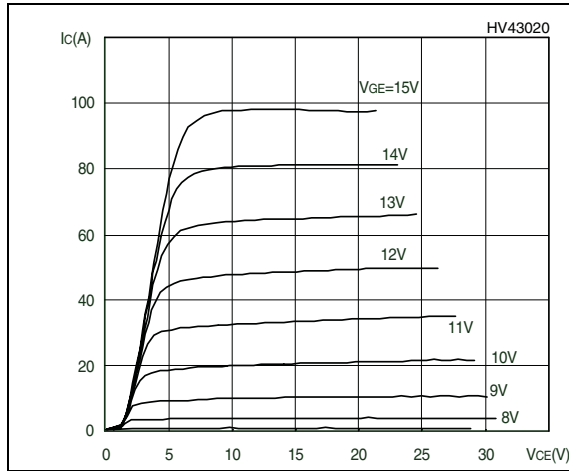

Figure 3. Transfer characteristics

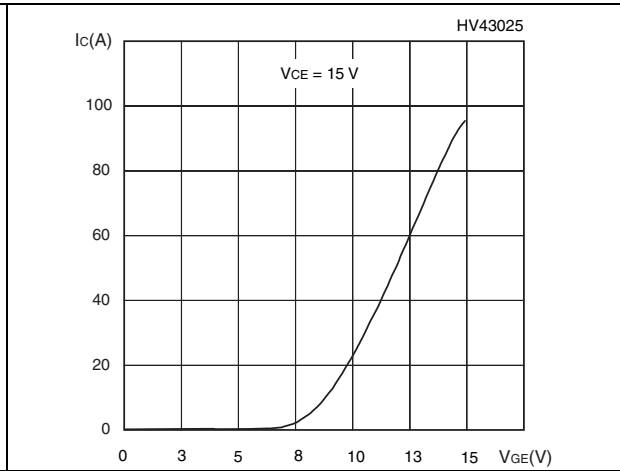

Figure 4. Transconductance

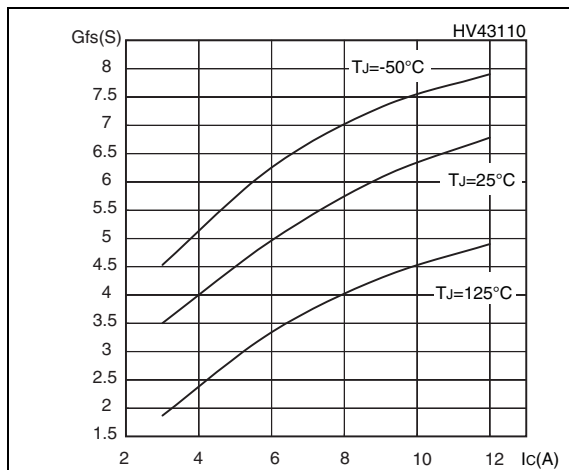

Figure 5. Collector-emitter on voltage vs temperature

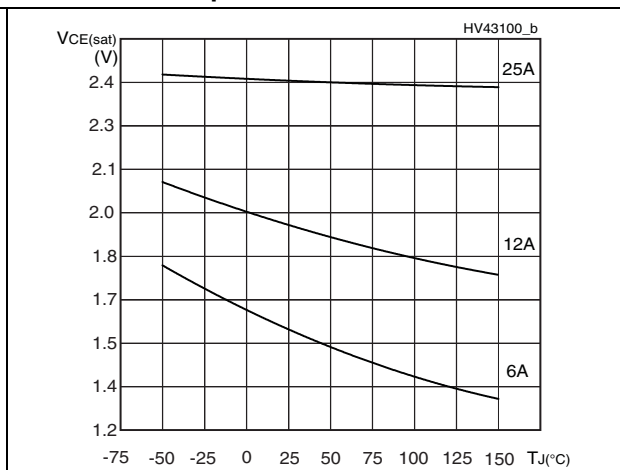

Figure 6. Gate charge vs gate-source voltage

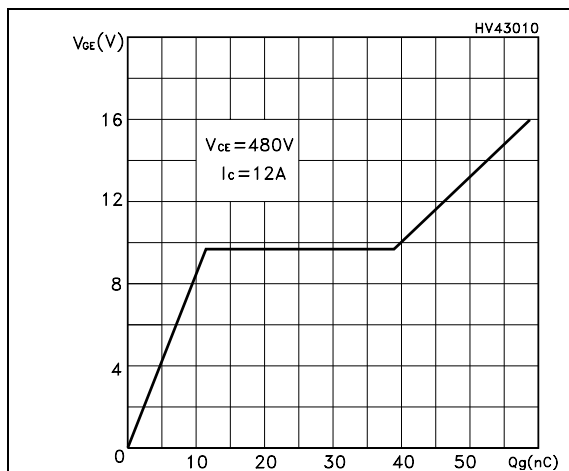
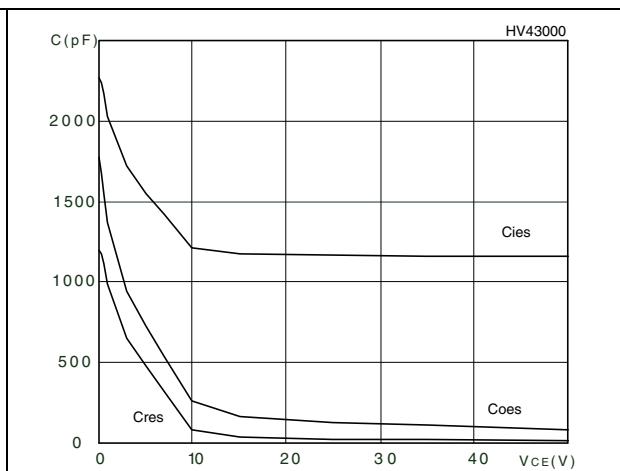
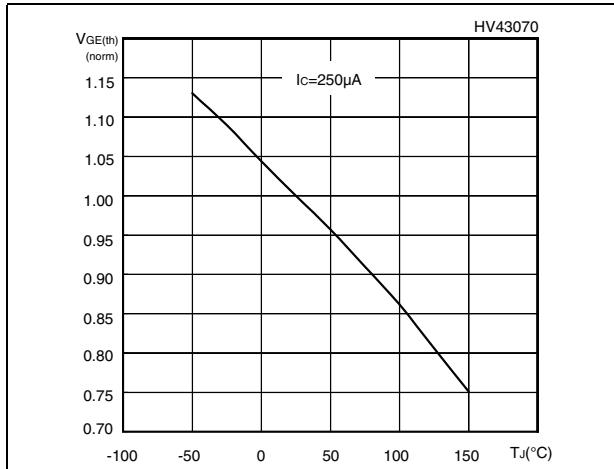

Figure 7. Capacitance variations



**Figure 8. Normalized gate threshold voltage vs temperature**



**Figure 9. Collector-emitter on voltage vs collector current**

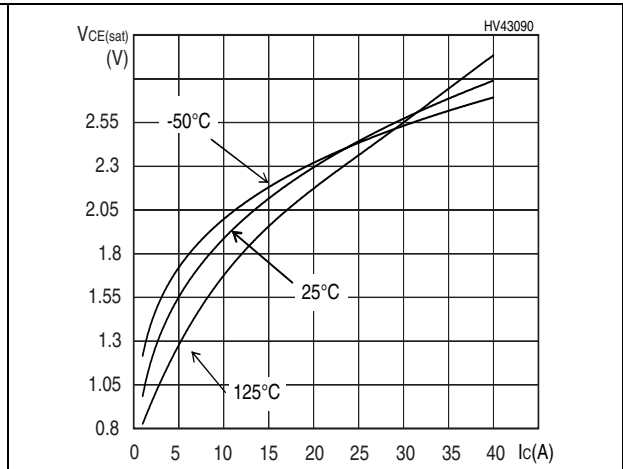

**Figure 10. Normalized breakdown voltage vs temperature**

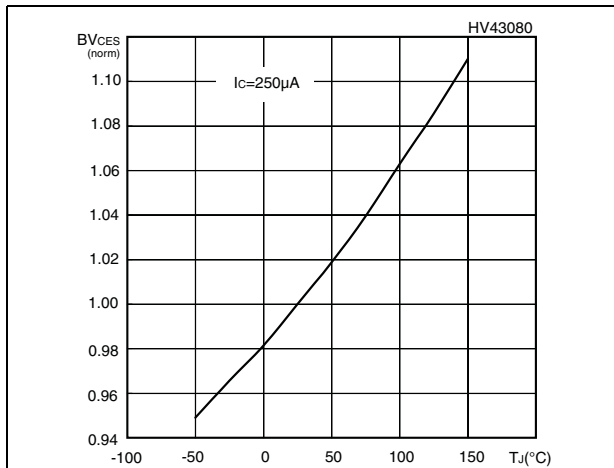

**Figure 11. Switching losses vs temperature**

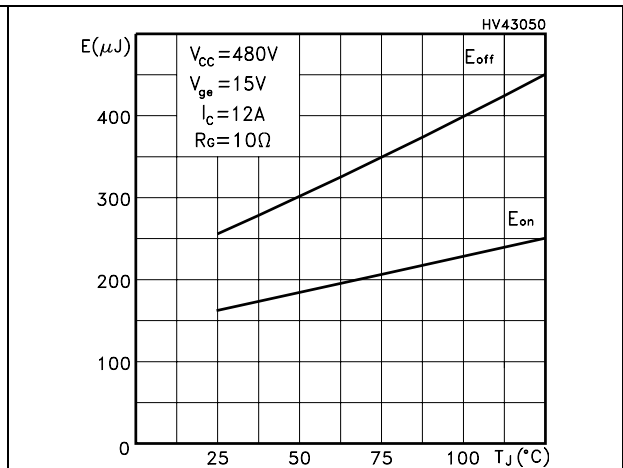

**Figure 12. Switching losses vs gate resistance**

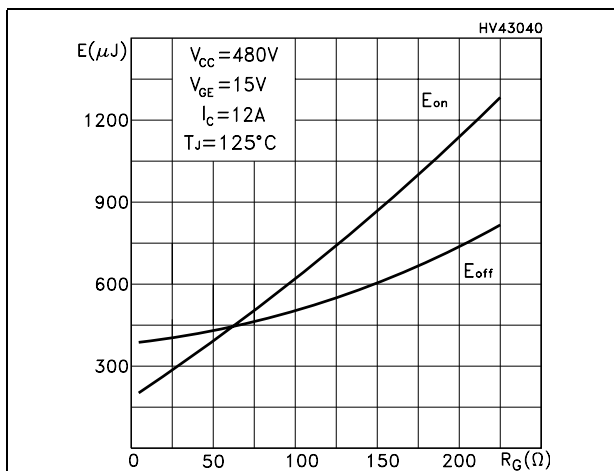

**Figure 13. Switching losses vs collector current**

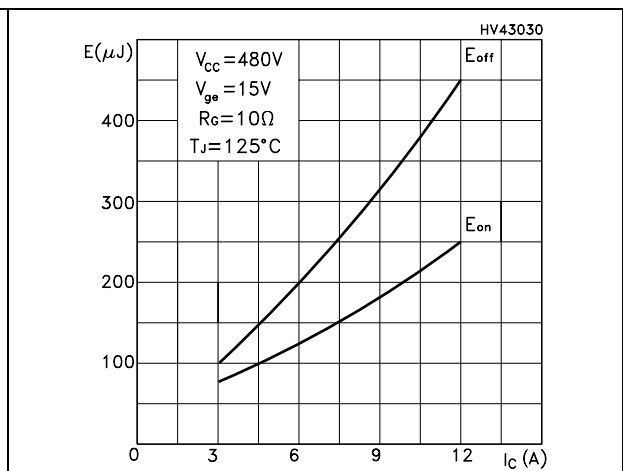



Figure 14. Turn-off SOA

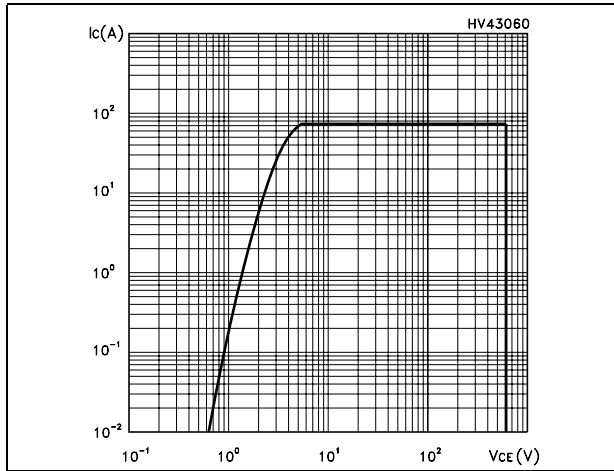

Figure 15. Emitter-collector diode characteristics

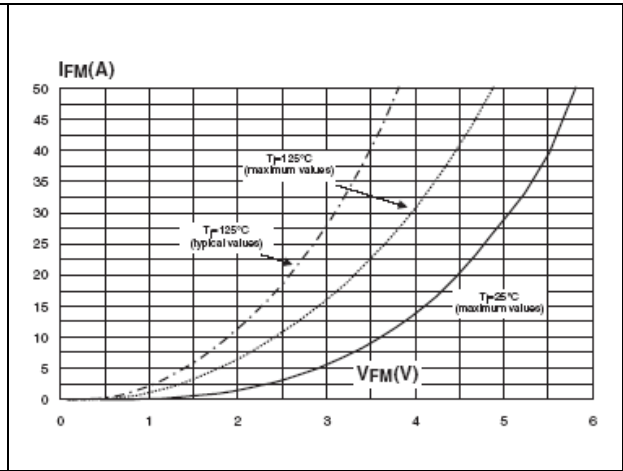

Figure 16. Thermal impedance for TO-220, D<sup>2</sup>PAK

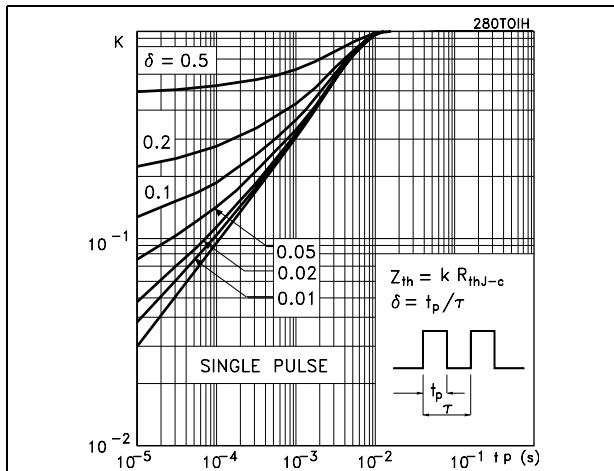
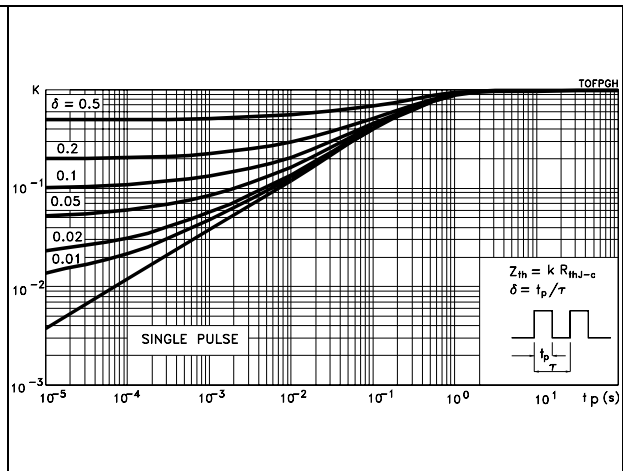

Figure 17. Thermal impedance for TO-220FP



### 3 Test circuits

Figure 18. Test circuit for inductive load switching

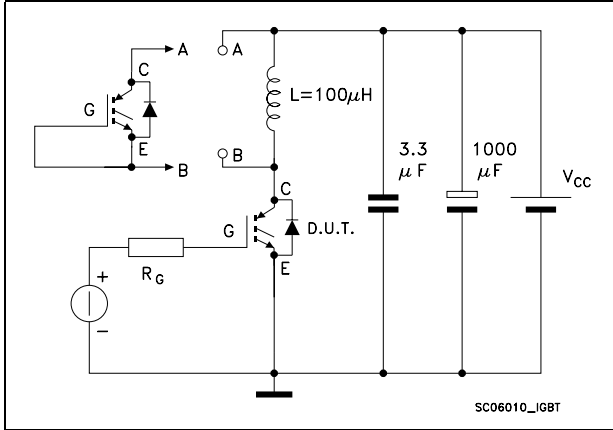

Figure 19. Gate charge test circuit

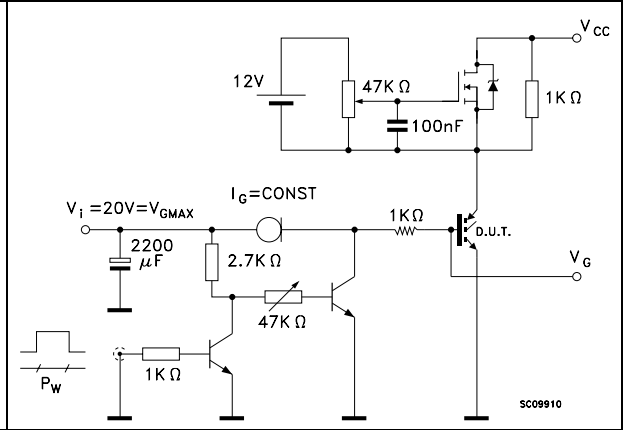

Figure 20. Switching waveforms

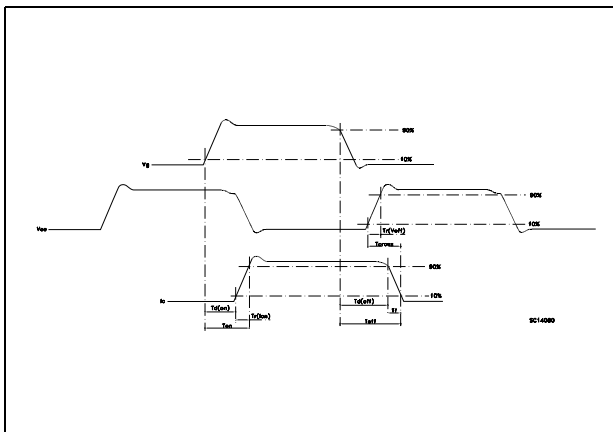
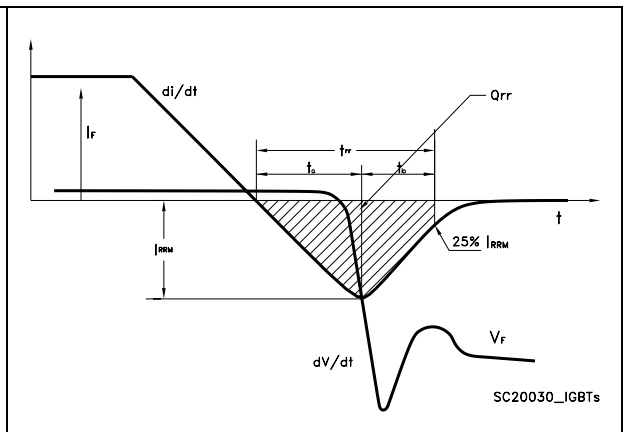

Figure 21. Diode recovery times waveform



## 4 Package mechanical data

In order to meet environmental requirements, ST offers these devices in ECOPACK® packages. These packages have a Lead-free second level interconnect. The category of second level interconnect is marked on the package and on the inner box label, in compliance with JEDEC Standard JESD97. The maximum ratings related to soldering conditions are also marked on the inner box label. ECOPACK is an ST trademark. ECOPACK specifications are available at: [www.st.com](http://www.st.com)

TO-220 mechanical data

Dim	mm			inch		
	Min	Typ	Max	Min	Typ	Max
A	4.40		4.60	0.173		0.181
b	0.61		0.88	0.024		0.034
b1	1.14		1.70	0.044		0.066
c	0.48		0.70	0.019		0.027
D	15.25		15.75	0.6		0.62
D1		1.27			0.050	
E	10		10.40	0.393		0.409
e	2.40		2.70	0.094		0.106
e1	4.95		5.15	0.194		0.202
F	1.23		1.32	0.048		0.051
H1	6.20		6.60	0.244		0.256
J1	2.40		2.72	0.094		0.107
L	13		14	0.511		0.551
L1	3.50		3.93	0.137		0.154
L20		16.40			0.645	
L30		28.90			1.137	
∅P	3.75		3.85	0.147		0.151
Q	2.65		2.95	0.104		0.116

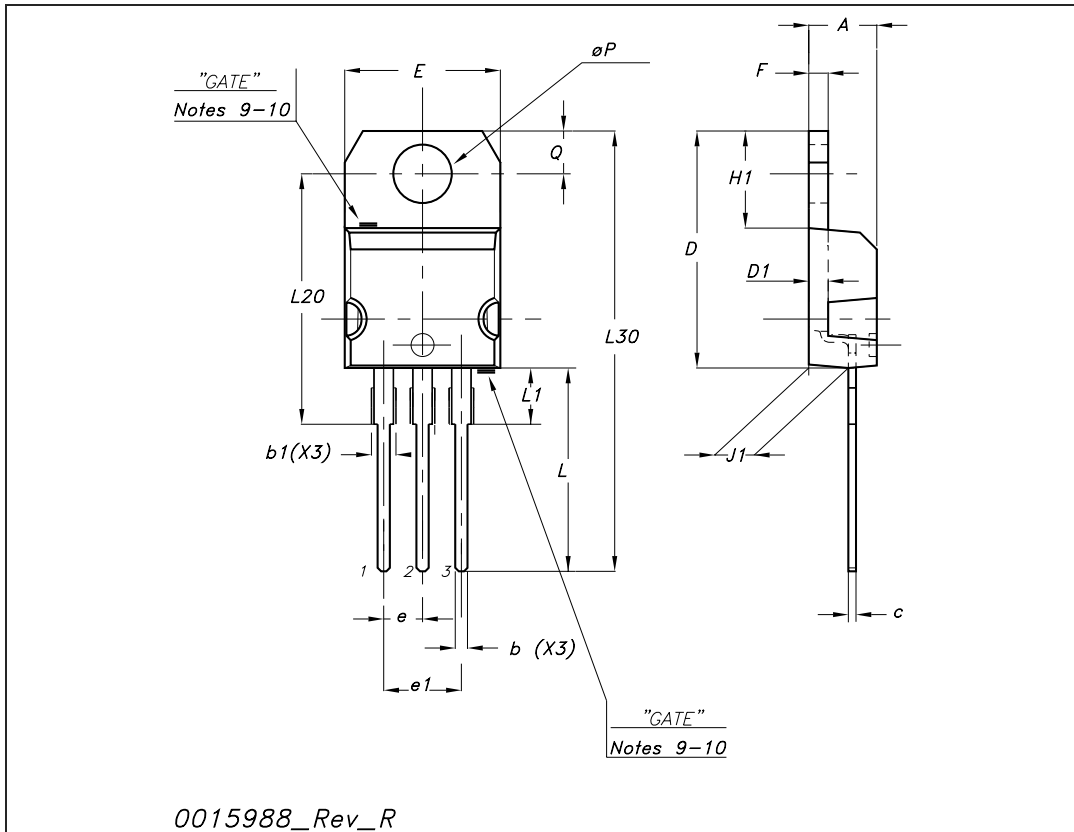

**TO-220FP mechanical data**

Dim.	mm.			inch		
	Min.	Typ	Max.	Min.	Typ.	Max.
A	4.40		4.60	0.173		0.181
B	2.5		2.7	0.098		0.106
D	2.5		2.75	0.098		0.108
E	0.45		0.70	0.017		0.027
F	0.75		1.00	0.030		0.039
F1	1.15		1.50	0.045		0.067
F2	1.15		1.50	0.045		0.067
G	4.95		5.20	0.195		0.204
G1	2.40		2.70	0.094		0.106
H	10		10.40	0.393		0.409
L2		16			0.630	
L3	28.6		30.6	1.126		1.204
L4	9.80		10.60	0.385		0.417
L5	2.9		3.6	0.114		0.141
L6	15.90		16.40	0.626		0.645
L7	9		9.30	0.354		0.366
Dia	3		3.2	0.118		0.126

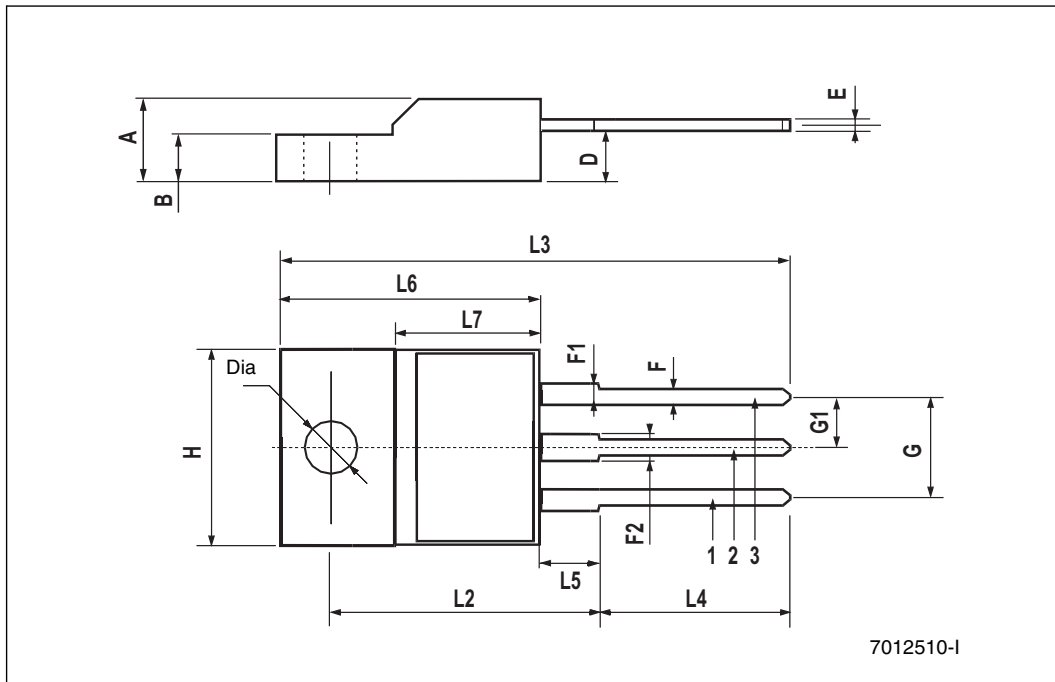

D<sup>2</sup>PAK (TO-263) mechanical data

Dim	mm			inch		
	Min	Typ	Max	Min	Typ	Max
A	4.40		4.60	0.173		0.181
A1	0.03		0.23	0.001		0.009
b	0.70		0.93	0.027		0.037
b2	1.14		1.70	0.045		0.067
c	0.45		0.60	0.017		0.024
c2	1.23		1.36	0.048		0.053
D	8.95		9.35	0.352		0.368
D1	7.50			0.295		
E	10		10.40	0.394		0.409
E1	8.50			0.334		
e		2.54			0.1	
e1	4.88		5.28	0.192		0.208
H	15		15.85	0.590		0.624
J1	2.49		2.69	0.099		0.106
L	2.29		2.79	0.090		0.110
L1	1.27		1.40	0.05		0.055
L2	1.30		1.75	0.051		0.069
R		0.4			0.016	
V2	0°		8°	0°		8°

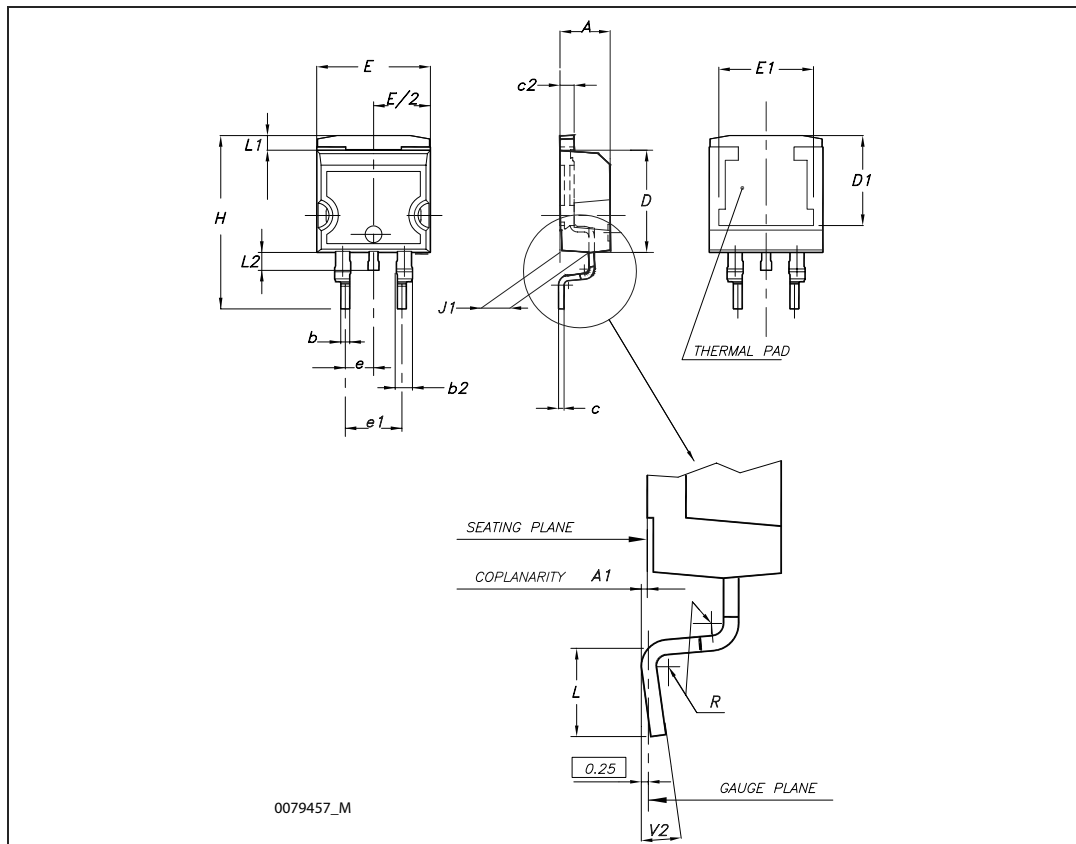

## 5 Packing mechanical data

### D<sup>2</sup>PAK FOOTPRINT

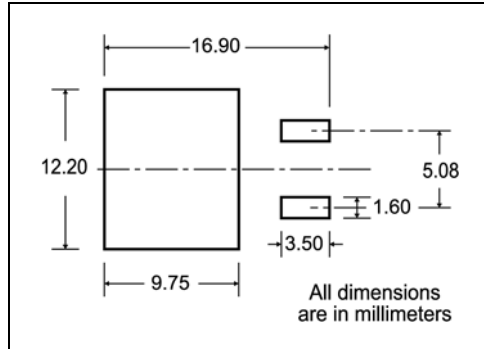

### TAPE AND REEL SHIPMENT

**TAPE MECHANICAL DATA**

DIM.	mm		inch	
	MIN.	MAX.	MIN.	MAX.
A0	10.5	10.7	0.413	0.421
B0	15.7	15.9	0.618	0.626
D	1.5	1.6	0.059	0.063
D1	1.59	1.61	0.062	0.063
E	1.65	1.85	0.065	0.073
F	11.4	11.6	0.449	0.456
K0	4.8	5.0	0.189	0.197
P0	3.9	4.1	0.153	0.161
P1	11.9	12.1	0.468	0.476
P2	1.9	2.1	0.075	0.082
R	50		1.574	
T	0.25	0.35	0.0098	0.0137
W	23.7	24.3	0.933	0.956

**REEL MECHANICAL DATA**

DIM.	mm		inch	
	MIN.	MAX.	MIN.	MAX.
A		330		12.992
B	1.5		0.059	
C	12.8	13.2	0.504	0.520
D	20.2		0.795	
G	24.4	26.4	0.960	1.039
N	100		3.937	
T		30.4		1.197

BASE QTY	BULK QTY
1000	1000

**TR**

\* on sales type

## 6 Revision history

**Table 9. Document revision history**

Date	Revision	Changes
08-May-2008	1	Initial release
28-May-2008	2	<ul style="list-style-type: none"><li>– Value on <a href="#">Table 3: Thermal resistance</a> has been changed.</li><li>– Inserted <a href="#">Figure 16: Thermal impedance for TO-220, D<sup>2</sup>PAK</a> and <a href="#">Figure 17: Thermal impedance for TO-220FP</a></li></ul>



**Please Read Carefully:**

Information in this document is provided solely in connection with ST products. STMicroelectronics NV and its subsidiaries ("ST") reserve the right to make changes, corrections, modifications or improvements, to this document, and the products and services described herein at any time, without notice.

All ST products are sold pursuant to ST's terms and conditions of sale.

Purchasers are solely responsible for the choice, selection and use of the ST products and services described herein, and ST assumes no liability whatsoever relating to the choice, selection or use of the ST products and services described herein.

No license, express or implied, by estoppel or otherwise, to any intellectual property rights is granted under this document. If any part of this document refers to any third party products or services it shall not be deemed a license grant by ST for the use of such third party products or services, or any intellectual property contained therein or considered as a warranty covering the use in any manner whatsoever of such third party products or services or any intellectual property contained therein.

**UNLESS OTHERWISE SET FORTH IN ST'S TERMS AND CONDITIONS OF SALE ST DISCLAIMS ANY EXPRESS OR IMPLIED WARRANTY WITH RESPECT TO THE USE AND/OR SALE OF ST PRODUCTS INCLUDING WITHOUT LIMITATION IMPLIED WARRANTIES OF MERCHANTABILITY, FITNESS FOR A PARTICULAR PURPOSE (AND THEIR EQUIVALENTS UNDER THE LAWS OF ANY JURISDICTION), OR INFRINGEMENT OF ANY PATENT, COPYRIGHT OR OTHER INTELLECTUAL PROPERTY RIGHT.**

**UNLESS EXPRESSLY APPROVED IN WRITING BY AN AUTHORIZED ST REPRESENTATIVE, ST PRODUCTS ARE NOT RECOMMENDED, AUTHORIZED OR WARRANTED FOR USE IN MILITARY, AIR CRAFT, SPACE, LIFE SAVING, OR LIFE SUSTAINING APPLICATIONS, NOR IN PRODUCTS OR SYSTEMS WHERE FAILURE OR MALFUNCTION MAY RESULT IN PERSONAL INJURY, DEATH, OR SEVERE PROPERTY OR ENVIRONMENTAL DAMAGE. ST PRODUCTS WHICH ARE NOT SPECIFIED AS "AUTOMOTIVE GRADE" MAY ONLY BE USED IN AUTOMOTIVE APPLICATIONS AT USER'S OWN RISK.**

Resale of ST products with provisions different from the statements and/or technical features set forth in this document shall immediately void any warranty granted by ST for the ST product or service described herein and shall not create or extend in any manner whatsoever, any liability of ST.

ST and the ST logo are trademarks or registered trademarks of ST in various countries.

Information in this document supersedes and replaces all information previously supplied.

The ST logo is a registered trademark of STMicroelectronics. All other names are the property of their respective owners.

© 2008 STMicroelectronics - All rights reserved

STMicroelectronics group of companies

Australia - Belgium - Brazil - Canada - China - Czech Republic - Finland - France - Germany - Hong Kong - India - Israel - Italy - Japan - Malaysia - Malta - Morocco - Singapore - Spain - Sweden - Switzerland - United Kingdom - United States of America

[www.st.com](http://www.st.com)