

Rail-to-rail input/output 8MHz operational amplifiers

Features

- Rail-to-rail input and output
- Wide bandwidth
- Low power consumption: 1.1mA max.
- Unity gain stability
- High output current: 35mA
- Operating from 2.5V to 5.5V
- Low input bias current
- ESD Internal protection $\geq 5kV$
- Latch-up immunity

Description

The TSV911/2/4 family of single, dual & quad operational amplifiers offers low voltage operation and rail-to-rail input and output.

This family features an excellent speed/power consumption ratio, offering an 8MHz gain-bandwidth product while consuming only 1.1mA max at 5V supply voltage. These op-amps are unity gain stable for capacitive loads up to 200pF. They also feature an ultra-low input bias current.

These characteristics make the TSV911/2/4 family ideal for sensor interfaces, battery-supplied and portable applications, as well as active filtering.

Applications

- Battery-powered applications
- Portable devices
- Signal conditioning
- Active filtering
- Medical instrumentation

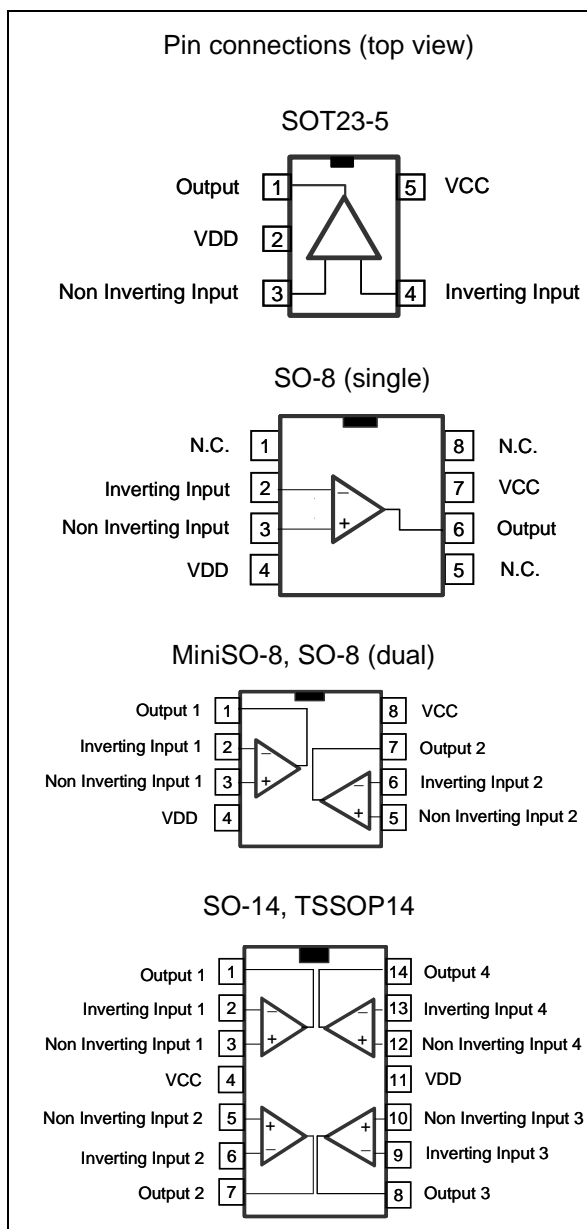

Contents

1	Device summary table	3
2	Absolute maximum ratings & operating conditions	4
3	Electrical characteristics	5
4	Package mechanical data	12
4.1	SOT23-5 package	12
4.2	MiniSO-8 package	13
4.3	SO-8 package	14
4.4	TSSOP14 package	15
4.5	SO-14 package	16
5	Revision history	17

1 Device summary table

Part number	Temperature range	Package	Packing	Marking
TSV911ID TSV911IDT	-40 - 125°C	SO-8	Tube or tape & reel	V911I
TSV911AID TSV911AIDT				V911AI
TSV911ILT		SOT23-5	Tape & reel	K127
TSV911AILT				
TSV912IST		MiniSO-8	Tape & reel	K125
TSV912AIST				
TSV912ID TSV912IDT		SO-8	Tube or tape & reel	V912I
TSV912AID TSV912AIDT				V912AI
TSV914IPT		TSSOP14	Tape & reel	V914I
TSV914AIPT				V914AI
TSV914ID TSV914IDT		SO-14	Tube or tape & reel	V914I
TSV914AID TSV914AIDT				V914AI
TSV911IYD TSV911IYDT		SO-8	Tube or tape & reel	V911IY
TSV911AIYD TSV911AIYDT				V911IAY
TSV912IYD TSV912IYDT		SO-8	Tube or tape & reel	V912IY
TSV912AIYD TSV912AIYDT				V912IAY
TSV914IYD TSV914IYDT		SO-14	Tube or tape & reel	V914IY
TSV914AIYD TSV914AIYDT				V914IAY

2 Absolute maximum ratings & operating conditions

Table 1. Absolute maximum ratings (AMR)

Symbol	Parameter	Value	Unit
V_{CC}	Supply voltage ⁽¹⁾	6	V
V_{id}	Differential input voltage ⁽²⁾	$\pm V_{CC}$	V
V_{in}	Input voltage ⁽³⁾	$V_{DD}-0.2$ to $V_{CC}+0.2$	V
T_{stg}	Storage temperature	-65 to +150	°C
R_{thja}	Thermal resistance junction to ambient ^{(4) (5)}	-	°C/W
	SOT23-5	250	
	SO-8	125	
	MiniSO-8	190	
	SO-14	103	
	TSSOP14	100	
R_{thjc}	Thermal resistance junction to case	-	°C/W
	SOT23-5	81	
	SO-8	40	
	MiniSO8	39	
	SO14	31	
	TSSOP14	32	
T_j	Maximum junction temperature	150	°C
ESD	HBM: human body model ⁽⁶⁾	5	kV
	MM: machine model ⁽⁷⁾	300	V
	CDM: charged device model ⁽⁸⁾	1.5	kV
	Latch-up immunity	200	mA

1. All voltage values, except differential voltage are with respect to network ground terminal.
2. Differential voltages are the non-inverting input terminal with respect to the inverting input terminal.
3. V_{CC} - V_{in} must not exceed 6V.
4. Short-circuits can cause excessive heating and destructive dissipation.
5. R_{th} are typical values.
6. Human body model: 100pF discharged through a 1.5kΩ resistor between two pins of the device, done for all couples of pin combinations with other pins floating.
7. Machine model: a 200pF cap is charged to the specified voltage, then discharged directly between two pins of the device with no external series resistor (internal resistor < 5Ω), done for all couples of pin combinations with other pins floating.
8. Charge device model: all pins plus package are charged together to the specified voltage and then discharged directly to the ground.

Table 2. Operating conditions

Symbol	Parameter	Value	Unit
V_{CC}	Supply voltage	2.5 to 5.5	V
V_{icm}	Common mode input voltage range	$V_{DD}-0.1$ to $V_{CC}+0.1$	V
T_{oper}	Operating free air temperature range	-40 to +125	°C

3 Electrical characteristics

Table 3. Electrical characteristics at $V_{CC} = +2.5V$

$V_{DD} = 0V$, $V_{icm} = V_{CC}/2$, $T_{amb} = 25^{\circ}C$, R_L connected to $V_{CC}/2$ (unless otherwise specified)

Symbol	Parameter	Conditions	Min.	Typ.	Max.	Unit
DC performance						
V_{io}	Offset voltage TSV91x		-	0.1	4.5	mV
		$T_{min.} < T_{op} < T_{max.}$	-	-	7.5	
	TSV91xA		-	-	1.5	
		$T_{min.} < T_{op} < T_{max.}$	-	-	3	
DV_{io}/DT	Input offset voltage drift		-	2	-	$\mu V/^{\circ}C$
I_{io}	Input offset current ($V_{out} = V_{CC}/2$)		-	1	$10^{(1)}$	pA
I_{ib}	Input bias current ($V_{out} = V_{CC}/2$)		-	1	$10^{(1)}$	pA
CMR	Common Mode rejection ratio $20 \log (\Delta V_{ic}/\Delta V_{io})$	0V to 2.5V, $V_{out} = 1.25V$	58	75	-	dB
A_{vd}	Large signal voltage gain	$R_L = 10k\Omega$, $V_{out} = 0.5V$ to $2V$	80	89	-	dB
$V_{CC}-V_{OH}$	High level output voltage	$R_L = 10k\Omega$ $R_L = 600\Omega$		15 45	40 150	mV
V_{OL}	Low level output voltage	$R_L = 10k\Omega$ $R_L = 600\Omega$	-	15 45	40 150	mV
I_{out}	Isink	$V_o = 2.5V$	18	32	-	mA
		$T_{min.} < T_{amb} < T_{max.}$	16	-	-	
	Isource	$V_o = 0V$	18	35	-	
		$T_{min.} < T_{amb} < T_{max.}$	16	-	-	
I_{CC}	Supply current (per operator)	No load, $V_{out} = V_{CC}/2$	-	0.78	1.1	mA
		$T_{min.} < T_{op} < T_{max.}$	-	-	1.1	
AC performance						
GBP	Gain bandwidth product	$R_L = 2k\Omega$, $C_L = 100pF$, $f = 100kHz$	-	8	-	MHz
F_u	Unity gain frequency	$R_L = 2k\Omega$, $C_L = 100pF$,		7.2		MHz
ϕ_m	Phase margin	$R_L = 2k\Omega$, $C_L = 100pF$	-	45	-	Degrees
G_m	Gain margin	$R_L = 2k\Omega$, $C_L = 100pF$	-	8	-	dB
SR	Slew rate	$R_L = 2k\Omega$, $C_L = 100pF$, $A_v = 1$	-	4.5	-	$V/\mu s$

Table 3. Electrical characteristics at $V_{CC} = +2.5V$ $V_{DD} = 0V$, $V_{icm} = V_{CC}/2$, $T_{amb} = 25^{\circ}C$, R_L connected to $V_{CC}/2$ (unless otherwise specified)

Symbol	Parameter	Conditions	Min.	Typ.	Max.	Unit
e_n	Equivalent input noise voltage	$f=10kHz$	-	27	-	$\frac{nV}{\sqrt{Hz}}$
THD+ e_n	Total harmonic distortion	$G=1$, $f=1kHz$, $R_I=2k\Omega$, $BW=22kHz$, $V_{icm}=(V_{CC}+1)/2$, $V_{out}=1.1V_{pp}$	-	0.001	-	%

1. Guaranteed by design.

Table 4. Electrical characteristics at $V_{CC} = +3.3V$ $V_{DD} = 0V$, $V_{icm} = V_{CC}/2$, $T_{amb} = 25^{\circ}C$, R_L connected to $V_{CC}/2$ (unless otherwise specified)

Symbol	Parameter	Conditions	Min.	Typ.	Max.	Unit
DC performance						
V_{io}	Offset voltage TSV91x	$T_{min.} < T_{op} < T_{max.}$	-	0.1	4.5	mV
		$T_{min.} < T_{op} < T_{max.}$	-	-	7.5	
	TSV91xA	$T_{min.} < T_{op} < T_{max.}$	-	-	1.5	
		$T_{min.} < T_{op} < T_{max.}$	-	-	3	
DV_{io}	Input offset voltage drift		-	2	-	$\mu V/^{\circ}C$
I_{io}	Input offset current		-	1	$10^{(1)}$	pA
I_{ib}	Input bias current		-	1	$10^{(1)}$	pA
CMR	Common mode rejection ratio $20 \log (\Delta V_{ic}/\Delta V_{io})$	$0V$ to $3.3V$, $V_{out} = 1.65V$	60	78	-	dB
A_{vd}	Large signal voltage gain	$R_L=10k\Omega$, $V_{out}= 0.5V$ to $2.8V$	80	90	-	dB
$V_{CC}-V_{OH}$	High level output voltage	$R_L = 10k\Omega$ $R_L = 600\Omega$		15 45	40 150	mV
V_{OL}	Low level output voltage	$R_L = 10k\Omega$ $R_L = 600\Omega$	-	15 45	40 150	mV
I_{out}	Isink	$V_o = 3.3V$	18	32	-	mA
		$T_{min.} < T_{amb} < T_{max.}$	16	-	-	
	Isource	$V_o = 0V$	18	35	-	
		$T_{min.} < T_{amb} < T_{max.}$	16	-	-	
I_{CC}	Supply current (per operator)	No load, $V_{out}=V_{CC}/2$	-	0.8	1.1	mA
		$T_{min.} < T_{op} < T_{max.}$	-	-	1.1	
AC performance						
GBP	Gain bandwidth product	$R_L = 2k\Omega$, $C_L = 100pF$, $f = 100kHz$	-	8	-	MHz
F_u	Unity gain frequency	$R_L = 2k\Omega$, $C_L=100pF$	-	7.2	-	MHz

Table 4. Electrical characteristics at $V_{CC} = +3.3V$ $V_{DD} = 0V$, $V_{icm} = V_{CC}/2$, $T_{amb} = 25^{\circ}C$, R_L connected to $V_{CC}/2$ (unless otherwise specified)

Symbol	Parameter	Conditions	Min.	Typ.	Max.	Unit
ϕ_m	Phase margin	$R_L = 2k\Omega$, $C_L = 100pF$, $f = 100kHz$	-	45	-	Degrees
G_m	Gain margin	$R_L = 2k\Omega$, $C_L = 100pF$, $f = 100kHz$	-	8	-	dB
SR	Slew rate	$R_L = 2k\Omega$, $C_L = 100pF$, $f = 100kHz$, $A_v=1$	-	4.5	-	V/ μs
e_n	Equivalent input noise voltage	$f=10kHz$	-	27	-	$\frac{nV}{\sqrt{Hz}}$
THD+ e_n	Total harmonic distortion	$G=1$, $f=1kHz$, $R_I=2k\Omega$, $BW=22kHz$, $V_{icm}=(V_{CC}+1)/2$, $V_{out}=1.9V_{pp}$	-	0.00 07	-	%

1. Guaranteed by design.

Table 5. Electrical characteristics at $V_{CC} = +5V$ $V_{DD} = 0V$, $V_{icm} = V_{CC}/2$, $T_{amb} = 25^{\circ}C$, R_L connected to $V_{CC}/2$ (unless otherwise specified)

Symbol	Parameter	Conditions	Min.	Typ.	Max.	Unit
DC performance						
V_{io}	Offset voltage TSV91x		-	0.1	4.5	mV
		$T_{min.} < T_{op} < T_{max.}$	-	-	7.5	
	TSV91xA		-	-	1.5	
		$T_{min.} < T_{op} < T_{max.}$	-	-	3	
DV_{io}	Input offset voltage drift		-	2	-	$\mu V/^{\circ}C$
I_{io}	Input offset current		-	1	$10^{(1)}$	pA
I_{ib}	Input bias current		-	1	$10^{(1)}$	pA
CMR	Common mode rejection ratio $20 \log (\Delta V_{ic}/\Delta V_{io})$	0V to 5V, $V_{out} = 2.5V$	62	82	-	dB
SVR	Supply voltage rejection ratio $20 \log (\Delta V_{CC}/\Delta V_{io})$	$V_{CC} = 2.5$ to 5V	70	86	-	dB
A_{vd}	Large signal voltage gain	$R_L=10k\Omega$, $V_{out}= 0.5V$ to 4.5V	80	91	-	dB
$V_{CC}-V_{OH}$	High level output voltage	$R_L = 10k\Omega$ $R_L = 600\Omega$		15 45	40 150	mV
V_{OL}	Low level output voltage	$R_L = 10k\Omega$ $R_L = 600\Omega$	-	15 45	40 150	mV
I_{out}	Isink	$V_o = 5V$	18	32	-	mA
		$T_{min.} < T_{amb} < T_{max.}$	16	-	-	
	Isource	$V_o = 0V$	18	35	-	
		$T_{min.} < T_{amb} < T_{max.}$	16	-	-	

Table 5. Electrical characteristics at $V_{CC} = +5V$ $V_{DD} = 0V$, $V_{icm} = V_{CC}/2$, $T_{amb} = 25^{\circ}C$, R_L connected to $V_{CC}/2$ (unless otherwise specified)

Symbol	Parameter	Conditions	Min.	Typ.	Max.	Unit
I_{CC}	Supply current (per operator)	No load, $V_{out}=2.5V$	-	0.82	1.1	mA
		$T_{min.} < T_{op} < T_{max.}$	-	-	1.1	
AC performance						
GBP	Gain bandwidth product	$R_L = 2k\Omega$, $C_L = 100pF$, $f = 100kHz$	-	8	-	MHz
F_u	Unity gain frequency	$R_L = 2k\Omega$, $C_L=100pF$	-	7.5	-	MHz
ϕ_m	Phase margin	$R_L = 2k\Omega$, $C_L=100pF$	-	45	-	Degrees
G_m	Gain margin	$R_L = 2k\Omega$, $C_L=100pF$	-	8	-	dB
SR	Slew rate	$R_L = 2k\Omega$, $C_L = 100pF$, $A_V = 1$	-	4.5	-	V/ μs
e_n	Equivalent input noise voltage	$f=10kHz$	-	27	-	$\frac{nV}{\sqrt{Hz}}$
THD+ e_n	Total harmonic distortion	$G=1$, $f=1kHz$, $R_I=2k\Omega$, $BW=22kHz$, $V_{icm}=(V_{cc}+1)/2$, $V_{out}=3.6V_{pp}$	-	0.0004	-	%

1. Guaranteed by design.

Figure 1. Input offset voltage distribution at T=25°C

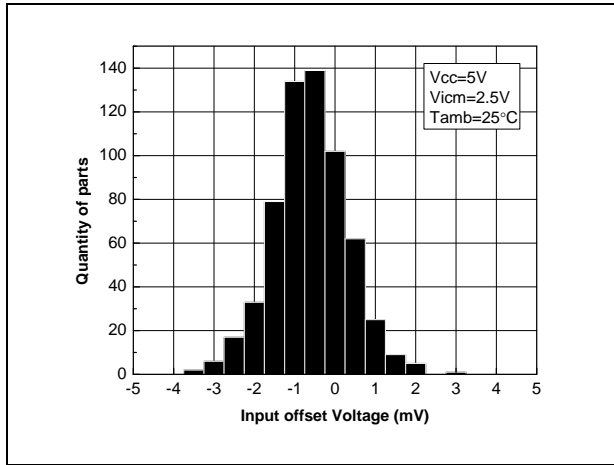

Figure 2. Input offset voltage distribution at T=125°C

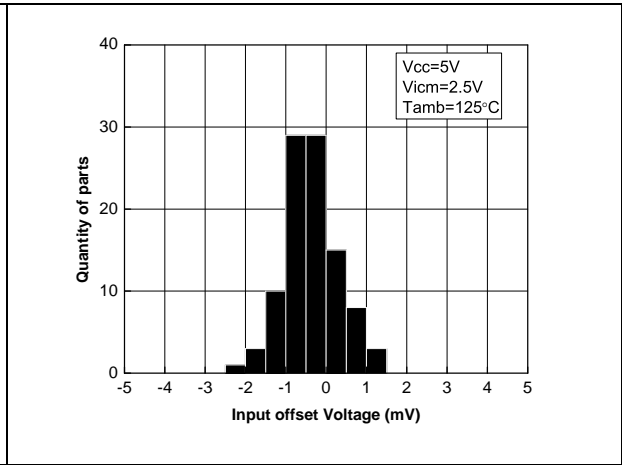

Figure 3. Supply current vs. input common mode voltage at Vcc=2.5V

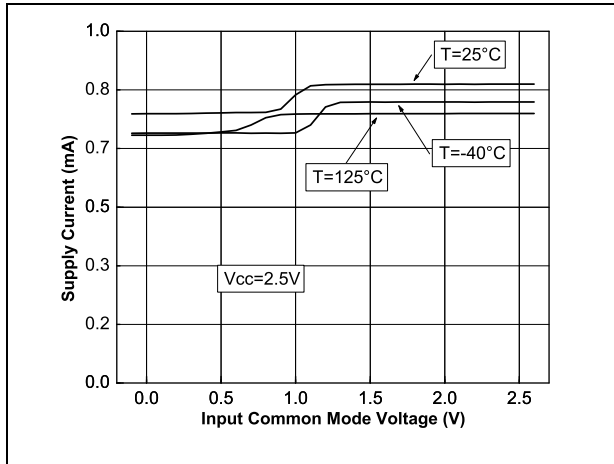

Figure 4. Supply current vs. input common mode voltage at Vcc=5V

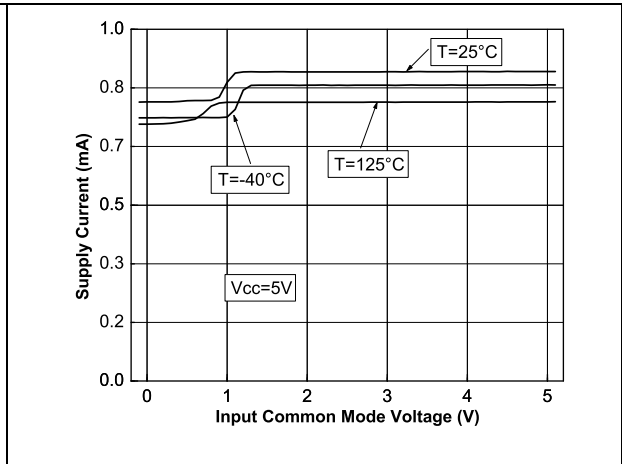

Figure 5. Output current vs. output voltage at Vcc=2.5V

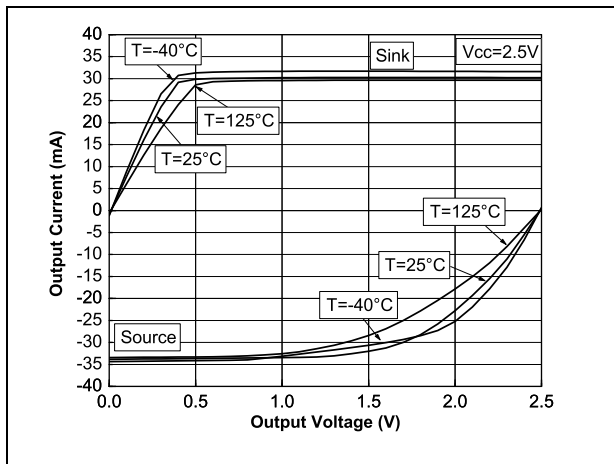

Figure 6. Output current vs. output voltage at Vcc=5V

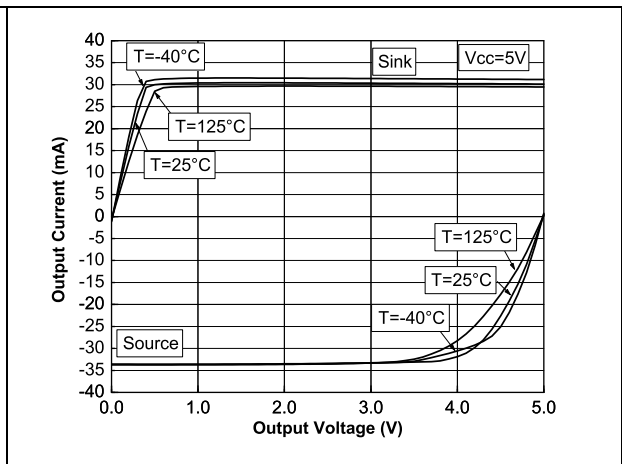

Figure 7. Voltage gain and phase vs frequency at Vcc=2.5V and Vicm=0.5V

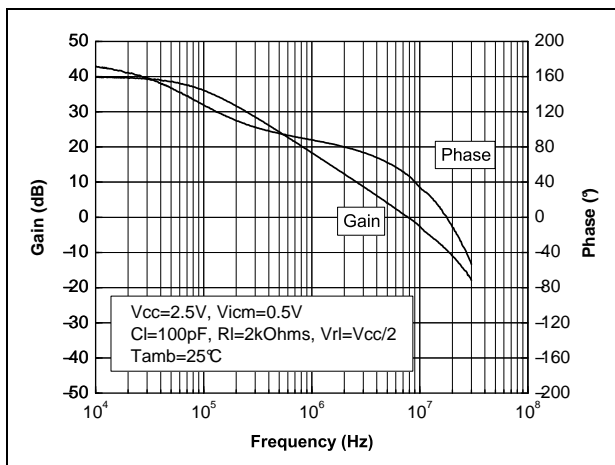

Figure 8. Voltage gain and phase vs frequency at Vcc=5.5V and Vicm=0.5V

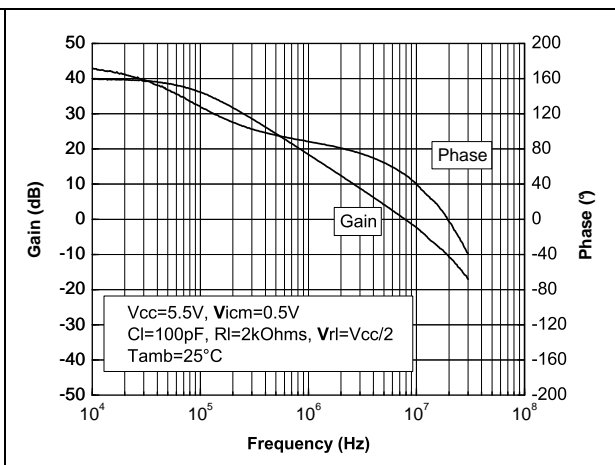

Figure 9. Phase margin vs. capacitive load

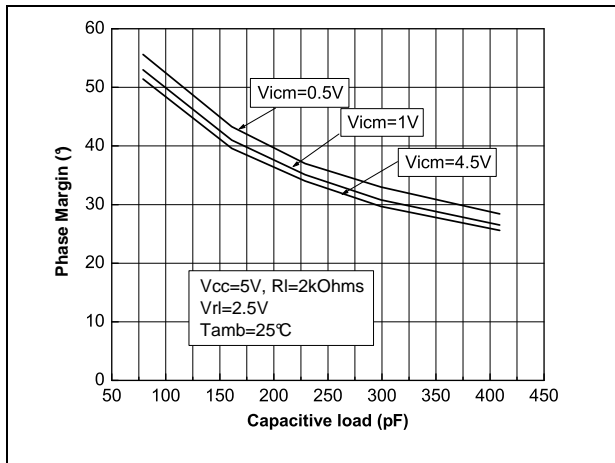

Figure 10. Phase margin vs. output current

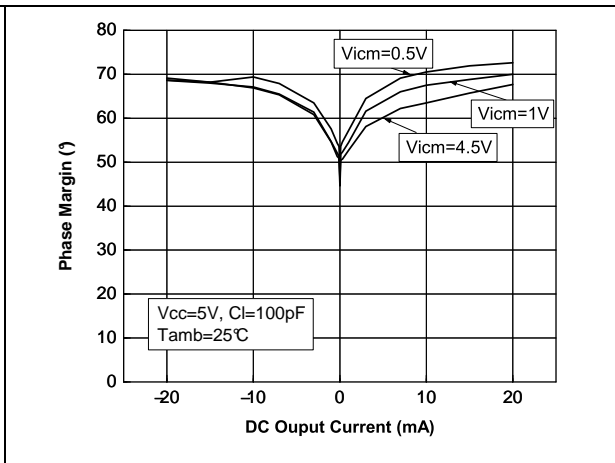

Figure 11. Positive slew rate

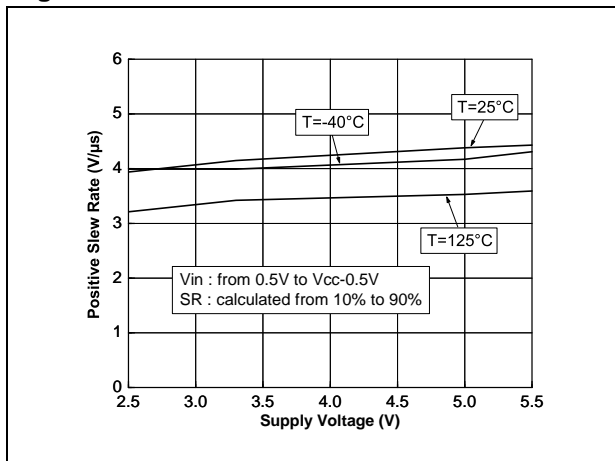

Figure 12. Negative slew rate

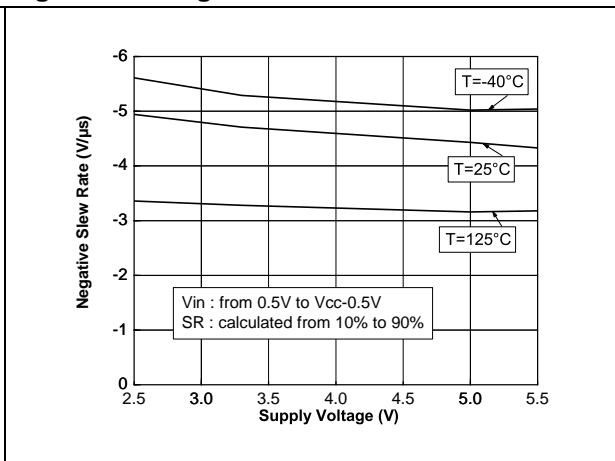

Figure 13. Distorsion + noise vs. frequency

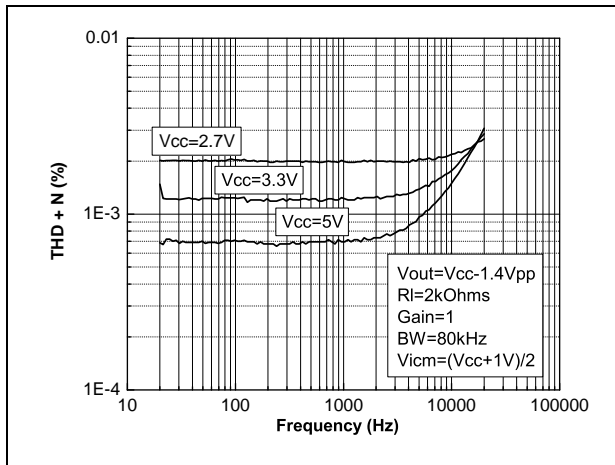

Figure 14. Distorsion + noise vs. output voltage

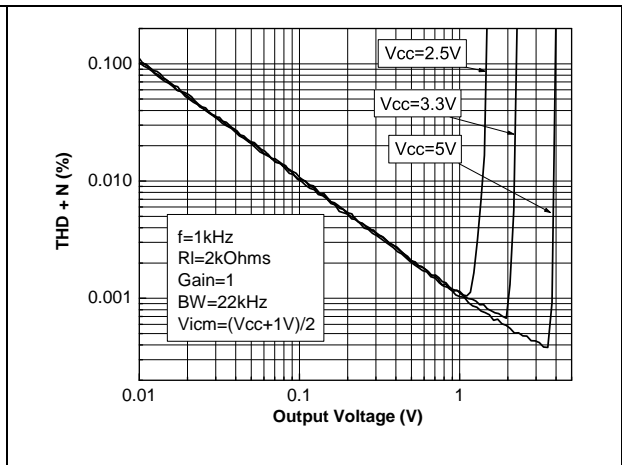
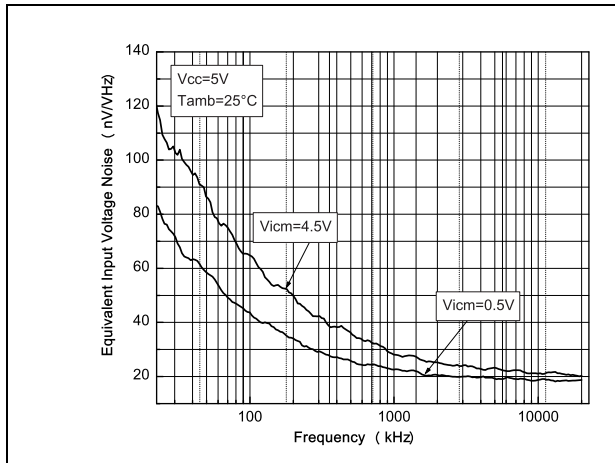

Figure 15. Noise vs. frequency



4 Package mechanical data

In order to meet environmental requirements, STMicroelectronics offers these devices in ECOPACK® packages. These packages have a lead-free second level interconnect. The category of second level interconnect is marked on the package and on the inner box label, in compliance with JEDEC Standard JESD97. The maximum ratings related to soldering conditions are also marked on the inner box label. ECOPACK is an STMicroelectronics trademark. ECOPACK specifications are available at: www.st.com.

4.1 SOT23-5 package

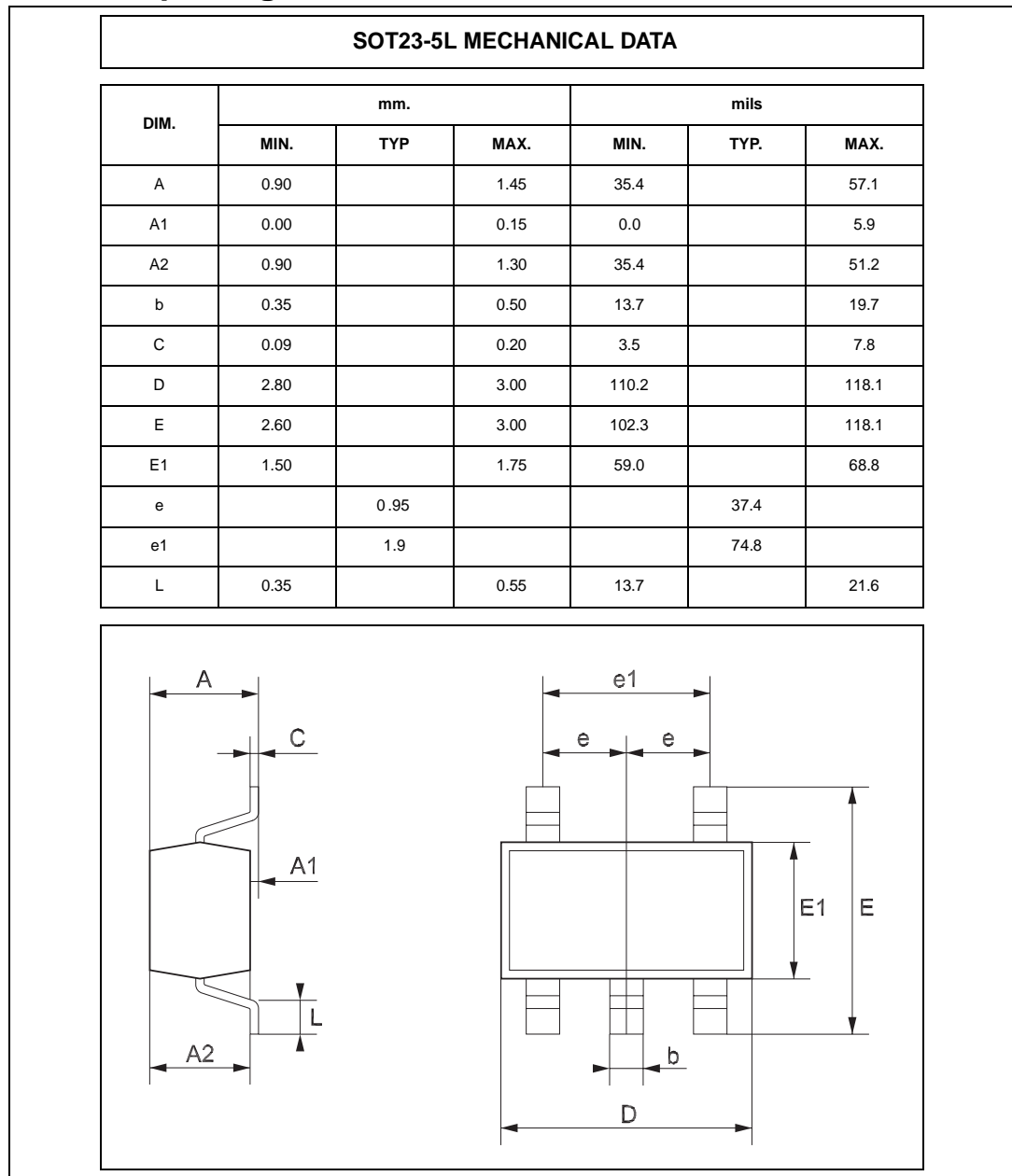

4.2 MiniSO-8 package

miniSO-8 MECHANICAL DATA						
DIM.	mm.			inch		
	MIN.	TYP.	MAX.	MIN.	TYP.	MAX.
A			1.1			0.043
A1	0.05	0.10	0.15	0.002	0.004	0.006
A2	0.78	0.86	0.94	0.031	0.031	0.037
b	0.25	0.33	0.40	0.010	0.13	0.013
c	0.13	0.18	0.23	0.005	0.007	0.009
D	2.90	3.00	3.10	0.114	0.118	0.122
E	4.75	4.90	5.05	0.187	0.193	0.199
E1	2.90	3.00	3.10	.0114	0.118	0.122
e		0.65			0.026	
K	0°		6°	0°		6°
L	0.40	0.55	0.70	0.016	0.022	0.028
L1			0.10			0.004

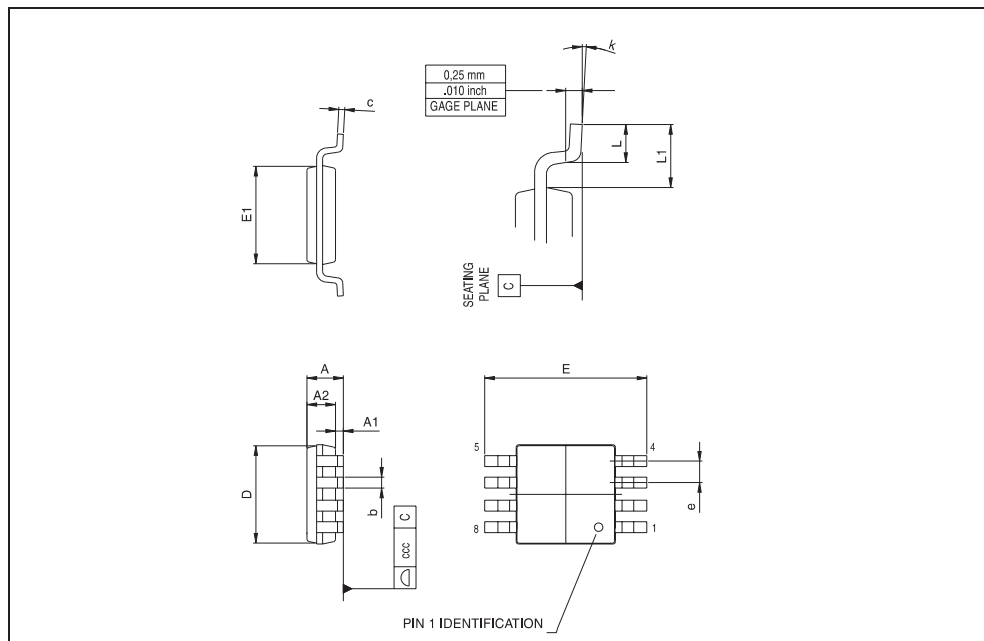

4.3 SO-8 package

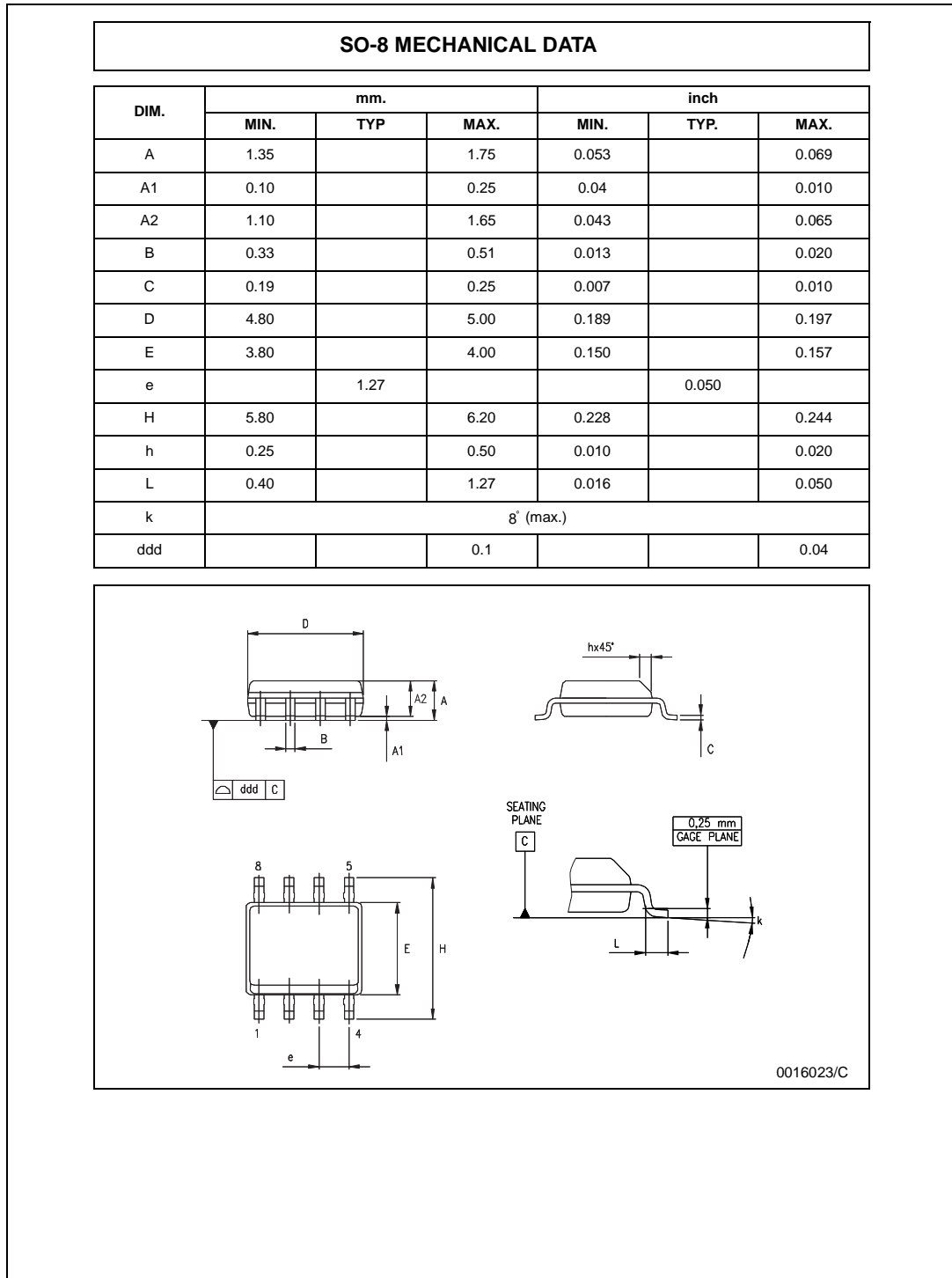

4.4 TSSOP14 package

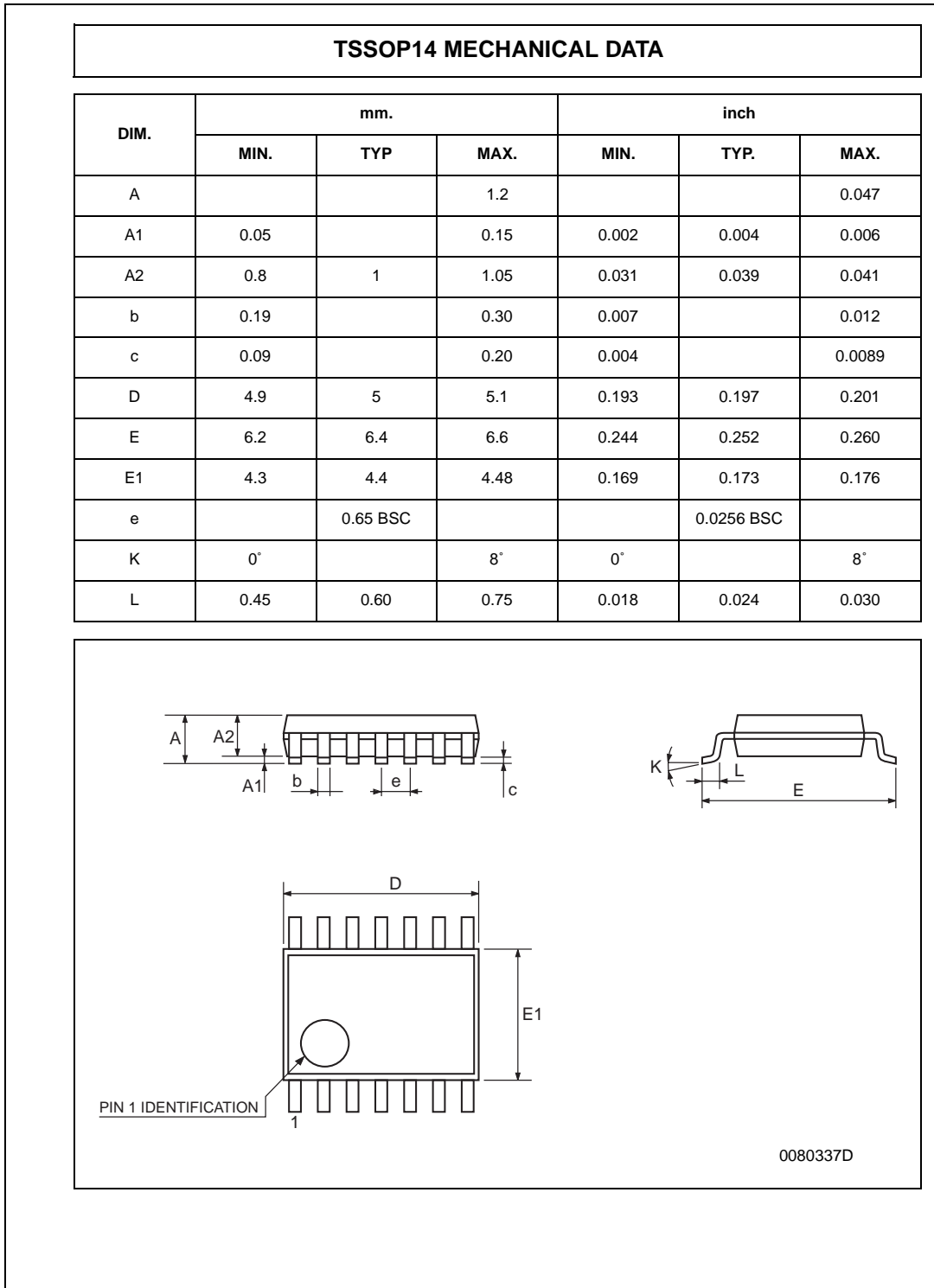

4.5 SO-14 package

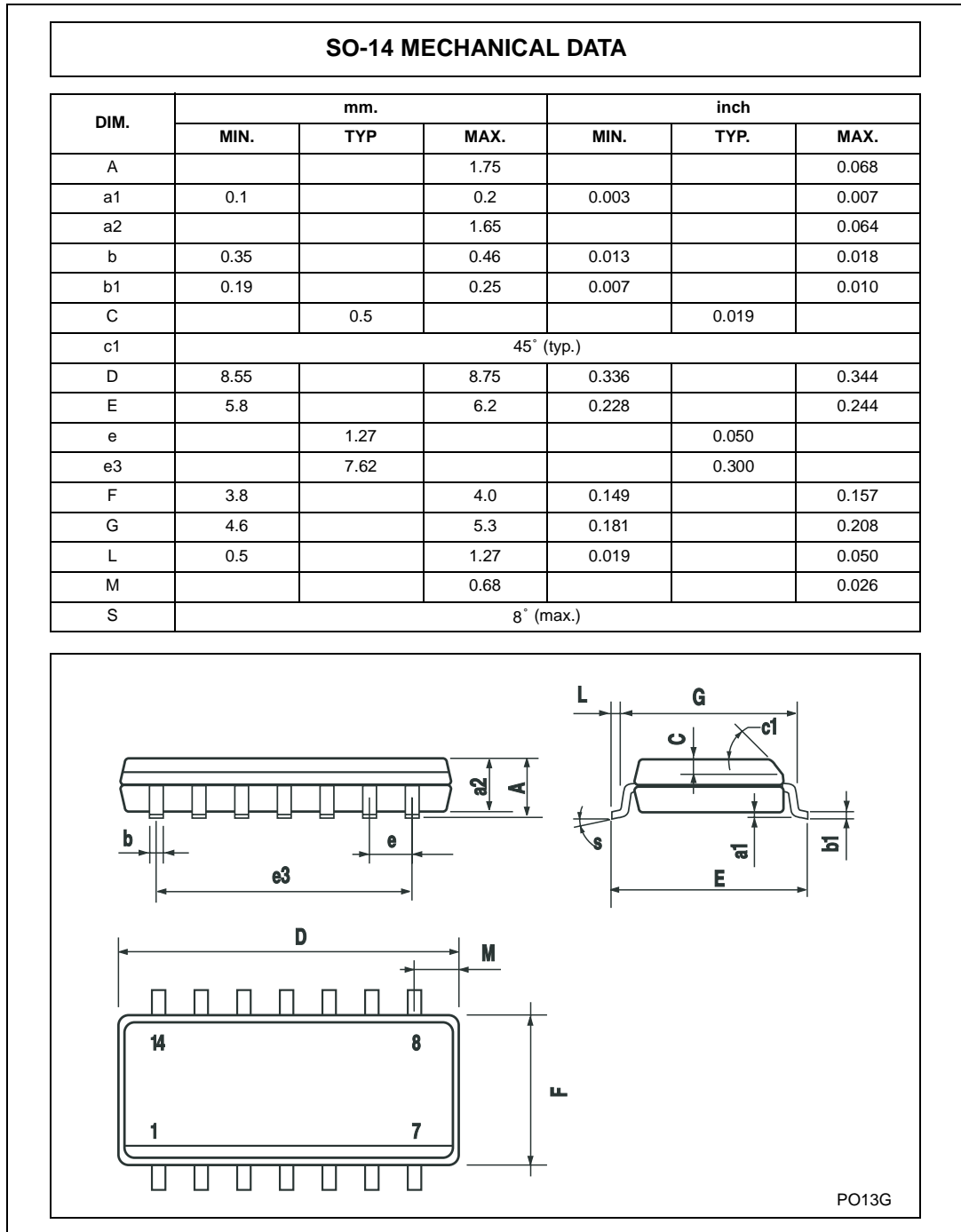

5 Revision history

Table 6. Document revision history

Date	Revision	Changes
28-Aug-2006	1	First release.

Please Read Carefully:

Information in this document is provided solely in connection with ST products. STMicroelectronics NV and its subsidiaries ("ST") reserve the right to make changes, corrections, modifications or improvements, to this document, and the products and services described herein at any time, without notice.

All ST products are sold pursuant to ST's terms and conditions of sale.

Purchasers are solely responsible for the choice, selection and use of the ST products and services described herein, and ST assumes no liability whatsoever relating to the choice, selection or use of the ST products and services described herein.

No license, express or implied, by estoppel or otherwise, to any intellectual property rights is granted under this document. If any part of this document refers to any third party products or services it shall not be deemed a license grant by ST for the use of such third party products or services, or any intellectual property contained therein or considered as a warranty covering the use in any manner whatsoever of such third party products or services or any intellectual property contained therein.

UNLESS OTHERWISE SET FORTH IN ST'S TERMS AND CONDITIONS OF SALE ST DISCLAIMS ANY EXPRESS OR IMPLIED WARRANTY WITH RESPECT TO THE USE AND/OR SALE OF ST PRODUCTS INCLUDING WITHOUT LIMITATION IMPLIED WARRANTIES OF MERCHANTABILITY, FITNESS FOR A PARTICULAR PURPOSE (AND THEIR EQUIVALENTS UNDER THE LAWS OF ANY JURISDICTION), OR INFRINGEMENT OF ANY PATENT, COPYRIGHT OR OTHER INTELLECTUAL PROPERTY RIGHT.

UNLESS EXPRESSLY APPROVED IN WRITING BY AN AUTHORIZED ST REPRESENTATIVE, ST PRODUCTS ARE NOT RECOMMENDED, AUTHORIZED OR WARRANTED FOR USE IN MILITARY, AIR CRAFT, SPACE, LIFE SAVING, OR LIFE SUSTAINING APPLICATIONS, NOR IN PRODUCTS OR SYSTEMS WHERE FAILURE OR MALFUNCTION MAY RESULT IN PERSONAL INJURY, DEATH, OR SEVERE PROPERTY OR ENVIRONMENTAL DAMAGE. ST PRODUCTS WHICH ARE NOT SPECIFIED AS "AUTOMOTIVE GRADE" MAY ONLY BE USED IN AUTOMOTIVE APPLICATIONS AT USER'S OWN RISK.

Resale of ST products with provisions different from the statements and/or technical features set forth in this document shall immediately void any warranty granted by ST for the ST product or service described herein and shall not create or extend in any manner whatsoever, any liability of ST.

ST and the ST logo are trademarks or registered trademarks of ST in various countries.

Information in this document supersedes and replaces all information previously supplied.

The ST logo is a registered trademark of STMicroelectronics. All other names are the property of their respective owners.

© 2006 STMicroelectronics - All rights reserved

STMicroelectronics group of companies

Australia - Belgium - Brazil - Canada - China - Czech Republic - Finland - France - Germany - Hong Kong - India - Israel - Italy - Japan - Malaysia - Malta - Morocco - Singapore - Spain - Sweden - Switzerland - United Kingdom - United States of America

www.st.com