

DATASHEET

Street Light Lens

S01.01.01.011 _SS-50X50-4-T3M

1.General Information

- ✓ Lens Material: PC
- ✓ Size: 50X50MM
- ✓ Beam angle: T3M (155x90°)
- ✓ Compatibility: 3030*4/5050 (PHILIPS/LUMILEDS)
- ✓ Efficiency: 93%
- ✓ Fasten: Screw
- ✓ IP class: N/A
- ✓ Seal: N/A
- ✓ RoHS: YES
- ✓ Color: Matt



2.MECHANICAL SPECIFICATION

UNIT:MM

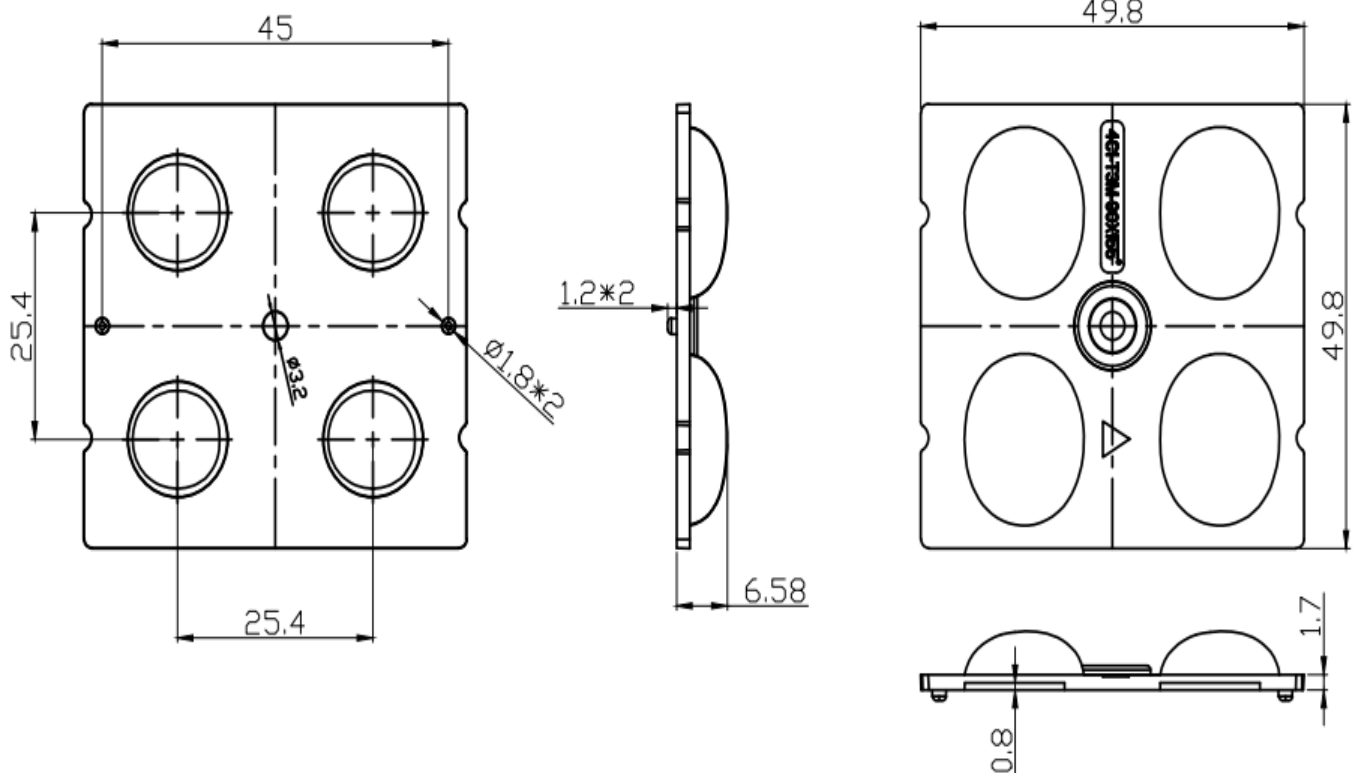

3.OPTICAL DATA

1) Simulation Data

Brand: Luxeon

LED model: 5050 Round

Light colour: White

FWTM: H164.7°,V123.1°

FWHM: H153.9°,V93.6°

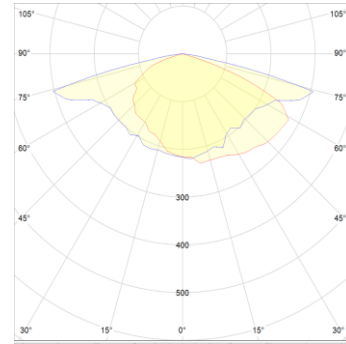

2) Test Data

Brand: Not simulate

LED model: Not simulate

Light colour: Not simulate

FWTM: Not simulate

FWHM: Not simulate

4.Usage and Maintenance

- 1) If necessary, clean lenses with mild soap, water and soft cloth.
- 2) Never use any commercial cleaning solvents on lenses, like alcohol.
- 3) Please handle lens with wearing gloves, skin oils may damage lens or its optical characteristic.

5.Note

Please test the data again before using. The chart data is for reference only.