

DATASHEET

Architectural light Lens S01.01.02.029_SG-D45-1-24

1.General Information

- ✓ Lens Material: PMMA
- ✓ Size: D45(MM)
- ✓ Beam angle: 24°
- ✓ Compatibility: CREE XM-L COLOR5050
- ✓ Efficiency: 90%
- ✓ Fasten: Frame
- ✓ IP class: N/A
- ✓ Seal: N/A
- ✓ RoHS: YES
- ✓ Color: Grid



2.MECHANICAL SPECIFICATION

UNIT:MM

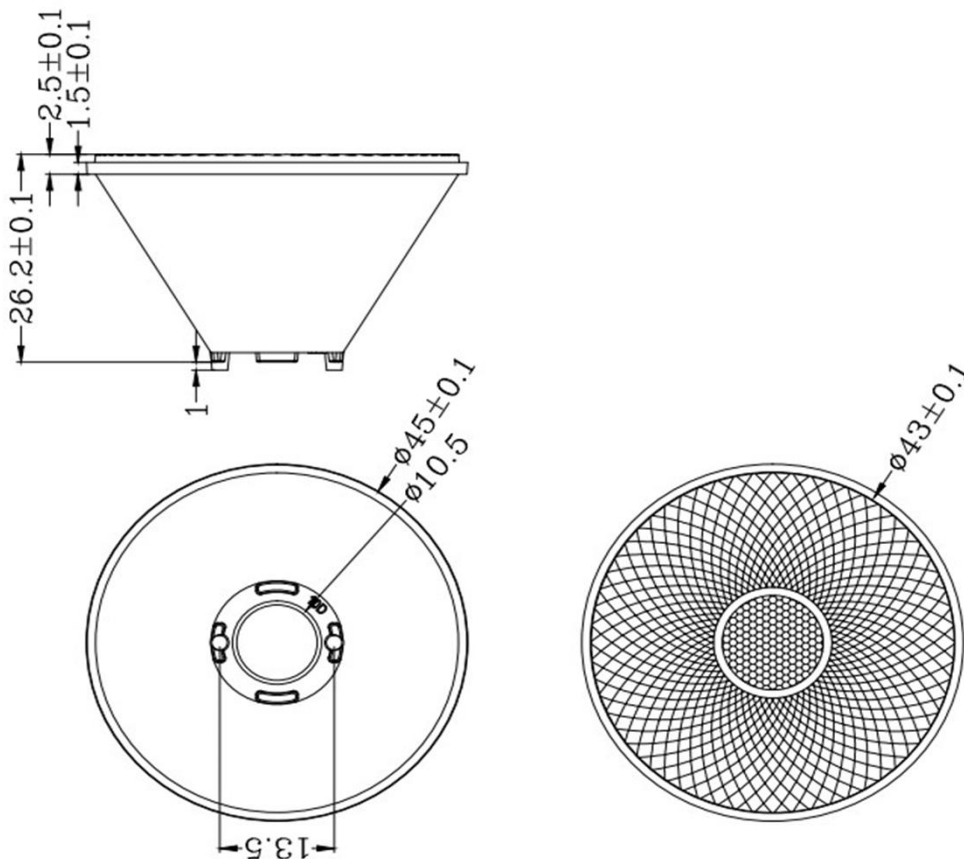

3.OPTICAL DATA

1) Simulation Data

Brand: CREE XM-L COLOR

LED model: 5050

Light colour: COLOR

FWTM: H34.7°,V34.6°

FWHM: H20.5°,V20.6°

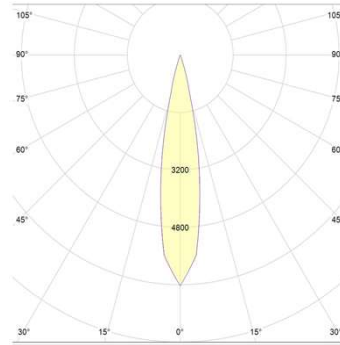

2) Test Data

Brand: Not simulate

LED model: Not simulate

Light colour: Not simulate

FWTM: Not simulate

FWHM: Not simulate

4.Usage and Maintenance

- 1) If necessary, clean lenses with mild soap, water and soft cloth.
- 2) Never use any commercial cleaning solvents on lenses, like alcohol.
- 3) Please handle lens with wearing gloves, skin oils may damage lens or its optical characteristic.

5.Note

Please test the data again before using. The chart data is for reference only.