

DATASHEET

Architectural light Lens S01.01.02.069 _SG-D23.22-1-30

1.General Information

- ✓ Lens Material: PMMA
- ✓ Size: D23.22 (mm)
- ✓ FWHM: 30°
- ✓ Design LED: CREE CLQ6A 5050
- ✓ Compatible LED size: /
- ✓ Efficiency: 93%
- ✓ Fasten: Glue
- ✓ IP class: N/A
- ✓ Seal: N/A
- ✓ RoHS: YES
- ✓ Color: Bead



2.MECHANICAL SPECIFICATION

UNIT:MM

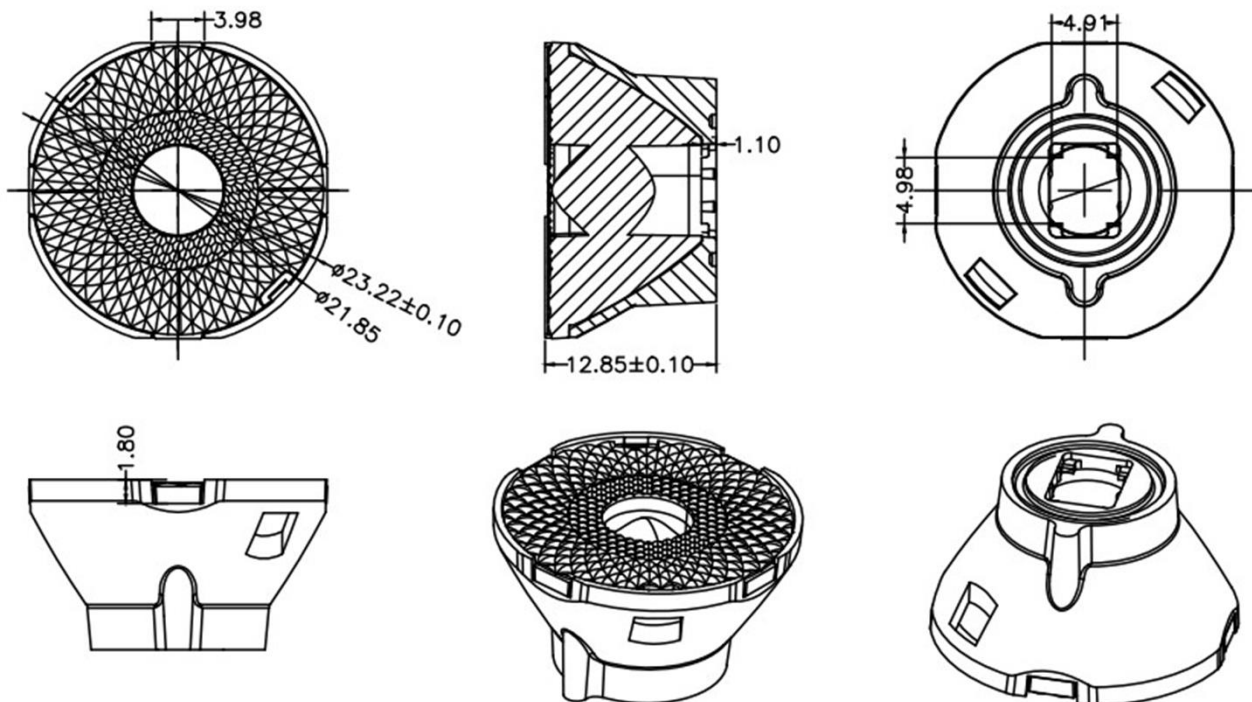

3.OPTICAL DATA

1) Simulation Data

Brand: CREE CLQ6A

LED model: 5050

Light colour: Color

FWTM: H64.8°,V64.9°

FWHM: H28.6°,V28.7°

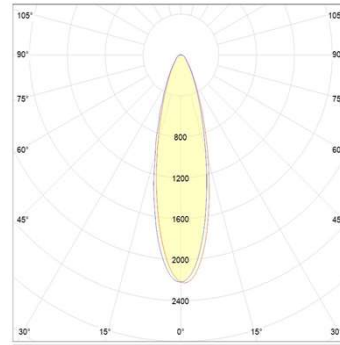

2) Test Data

Brand: Not simulate

LED model: Not simulate

Light colour: Not simulate

FWTM: Not simulate

FWHM: Not simulate

4.Usage and Maintenance

- 1) If necessary, clean lenses with mild soap, water and soft cloth.
- 2) Never use any commercial cleaning solvents on lenses, like alcohol.
- 3) Please handle lens with wearing gloves, skin oils may damage lens or its optical characteristic.

5.Note

Please test the data again before using. The chart data is for reference only.