

## DATASHEET

### Architectural light Lens S01.01.02.081 \_SG-D23.22-1-35

#### 1.General Information

- ✓ Lens Material: PMMA
- ✓ Size: D23.22 (mm)
- ✓ FWHM: 35°
- ✓ Design LED: OSRAM 3030
- ✓ Compatible LED size: 3535/5050
- ✓ Efficiency: 93%
- ✓ Fasten: Glue/PIN
- ✓ IP class: N/A
- ✓ Seal: N/A
- ✓ RoHS: YES
- ✓ Color: Bead

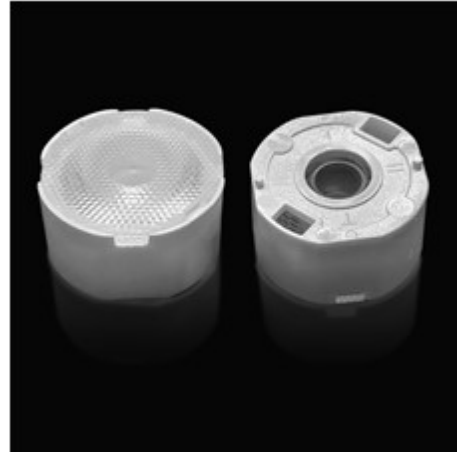

#### 2.MECHANICAL SPECIFICATION

UNIT:MM

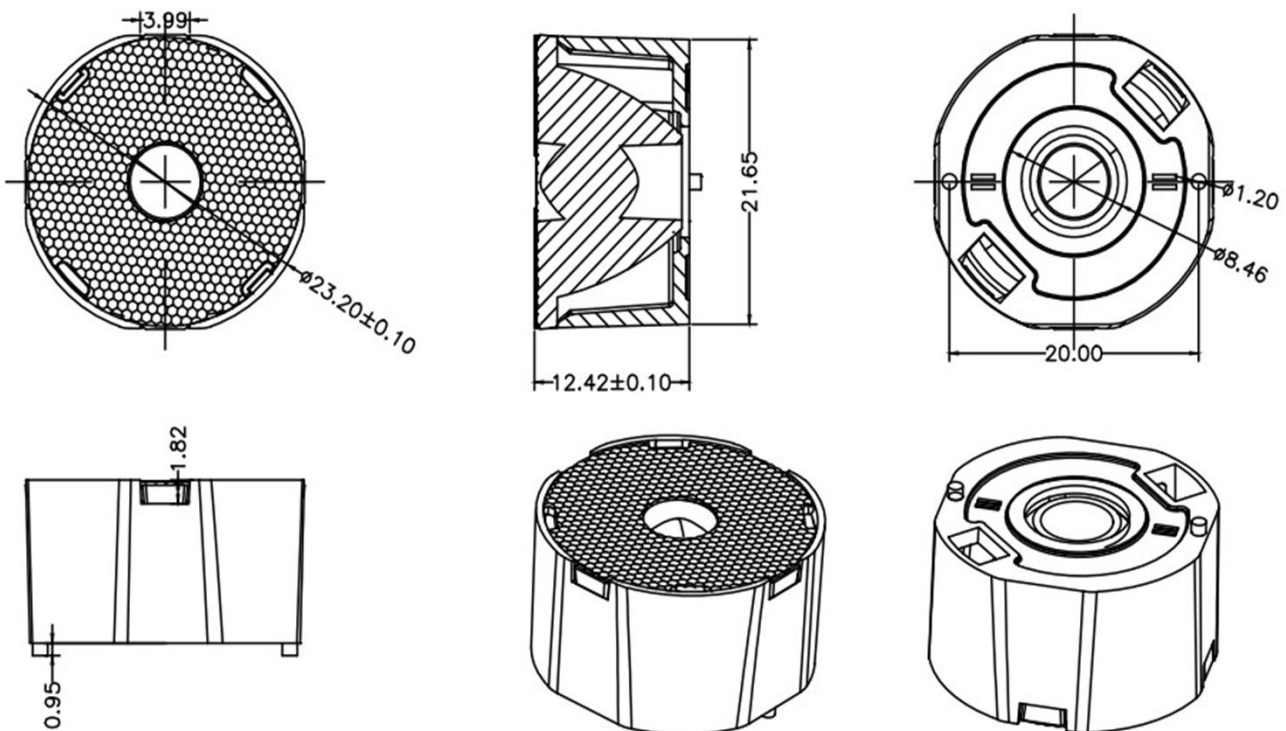

## 3.OPTICAL DATA

### 1) Simulation Data

Brand: OSRAM

LED model: 3030

Light colour: Wihite

FWTM: H65.9°,V66.4°

FWHM: H33.3°,V33.5°

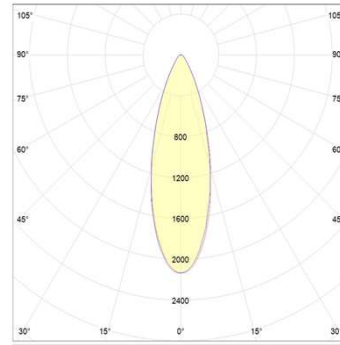

### 2) Test Data

Brand: Not simulate

LED model: Not simulate

Light colour: Not simulate

FWTM: Not simulate

FWHM: Not simulate

## 4.Usage and Maintenance

- 1) If necessary, clean lenses with mild soap, water and soft cloth.
- 2) Never use any commercial cleaning solvents on lenses, like alcohol.
- 3) Please handle lens with wearing gloves, skin oils may damage lens or its optical characteristic.

## 5.Note

Please test the data again before using. The chart data is for reference only.