

FEATURES

- Maximum output current : 600mA
- Highly accurate: Output voltage $\pm 1.5\%$
- Stability with Low ESR Capacitors
- Low power consumption
- On-chip Protections: Thermal, Short Circuit
- Small input/output differential: 600mV at 600mA
- Adjustable version

APPLICATION

- Battery-Operated Systems
- Portable Computers
- Portable Cameras and Video Recorders
- Reference Voltage Sources
- Instrumentation
- Pagers

DESCRIPTION

The LM8805 series is a low-dropout linear regulator. There are devices designed specifically for battery-operated systems. Ground current is very small (50uA-Typ), that significantly extending battery life. Low power consumption and high accuracy is achieved through CMOS and programmable fuse technologies. Output voltage: 1.5V to 6.0V.

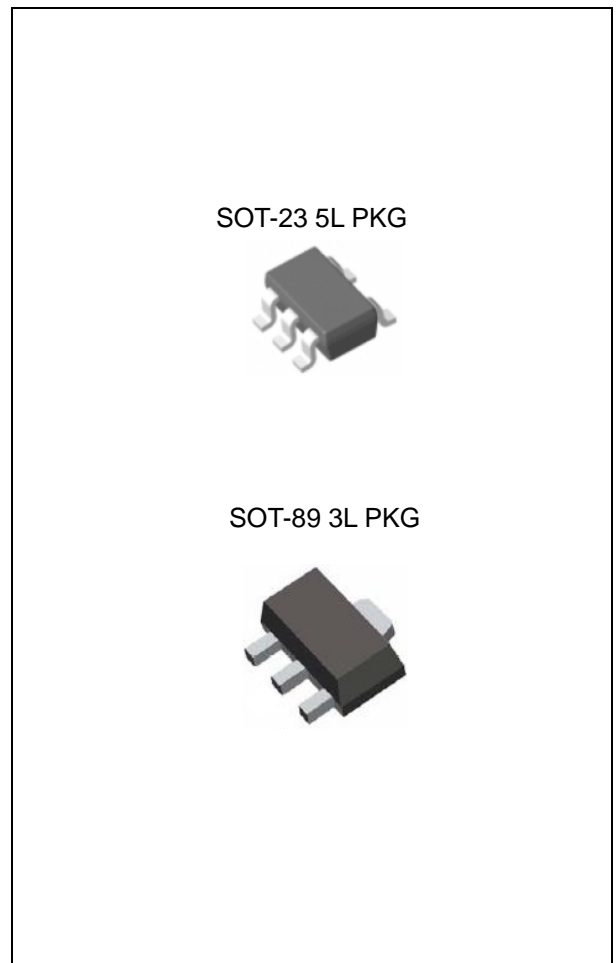

ORDERING INFORMATION

Device	Package
LM8805SF5-x.x	SOT-23-5L
LM8805F-x.x	SOT-89

x.x = Output Voltage = ADJ, 1.2V, 1.8V, 2.5V, 3.3V

Absolute Maximum Ratings

CHARACTERISTIC	SYMBOL	MIN.	MAX.	UNIT
Input Voltage	V_{IN}	-	8	V
Output Current	I_{OUT}	-	1	A
Output Voltage	V_{OUT}	$V_{SS} - 0.3$	$V_{IN} + 0.3$	V
Storage Temperature Range	T_{STG}	-40	125	$^{\circ}C$
Operating Ambient Temperature	T_A	-40	125	$^{\circ}C$

Ordering Information

V _{OUT}	Package	Order No.	Description	Package Marking	Supplied As	Status
ADJ	SOT-23 5L	LM8805SF5-ADJ	600mA, Enable, Adjustable	G00Y	Reel	Active
1.2 V	SOT-23 5L	LM8805SF5-1.2	600mA, Fixed	G12Y	Reel	Active
	SOT-89 3L	LM8805F-1.2	600mA, Fixed	8805 1.2 Yww	Reel	Contact us
1.8V	SOT-23 5L	LM8805SF5-1.8	600mA, Fixed	G18Y	Reel	Active
2.5 V	SOT-23 5L	LM8805SF5-2.5	600mA, Fixed	G25Y	Reel	Active
	SOT-89 3L	LM8805F-2.5	600mA, Fixed	8805 2.5 Yww	Reel	Active
3.3 V	SOT-23 5L	LM8805SF5-3.3	600mA, Fixed	G33Y	Reel	Active
	SOT-89 3L	LM8805F-3.3	600mA, Fixed	8805 3.3 Yww	Reel	Active

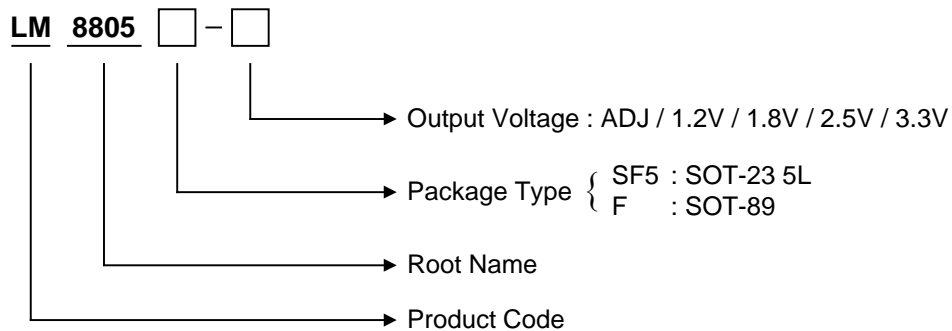

PIN CONFIGURATION

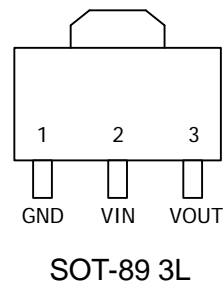
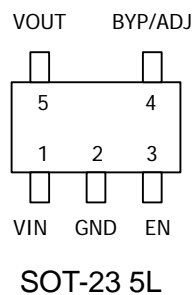

PIN DESCRIPTION

Pin No.	SOT-23 5L		SOT-89 3L	
	Name	Function	Name	Function
1	V _{IN}	Input Supply	GND	Ground
2	GND	Ground	V _{IN}	Input Supply
3	EN	Enable	V _{OUT}	Output Voltage
4	BYP/ADJ	Bypass for Fixed output or Output adjust for Adjustable output	-	-
5	V _{OUT}	Output Voltage	-	-

TYPICAL APPLICATION

Typical 3 Pin Application Circuit

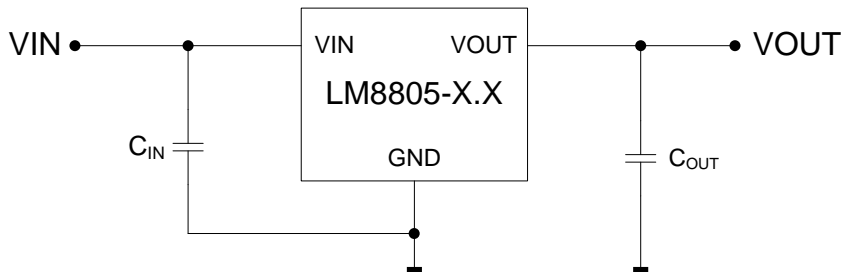

Typical 5 Pin Application Circuit

- Output Adjustment (Adjustable version)

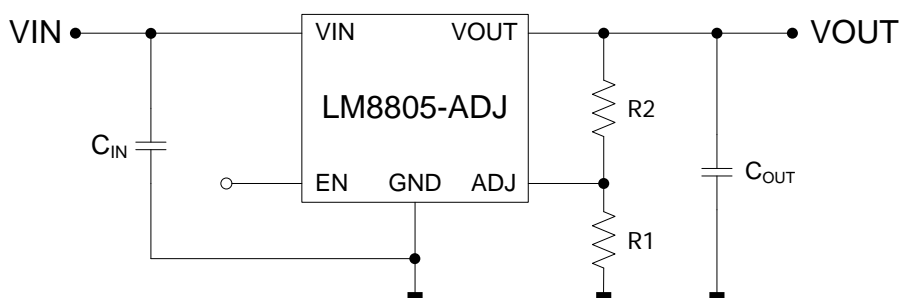

- Fixed Voltage Application

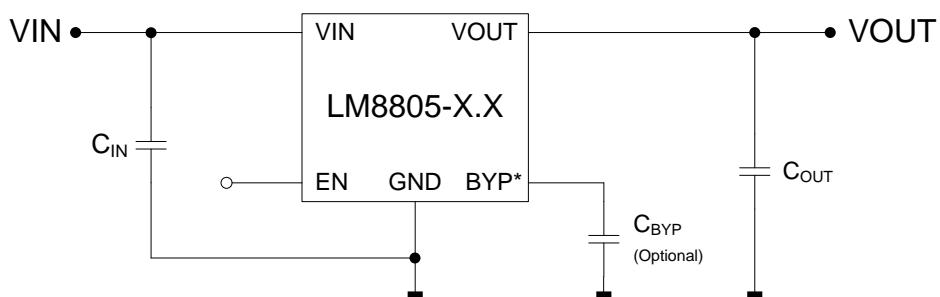

* Note) BYP pin can be left open if low noise operation is not required.

ELECTRICAL CHARACTERISTICS

(At $T_A = 25^\circ\text{C}$, $V_{IN} = V_{OUT}(\text{nominal}) + 1\text{V}$, unless otherwise noted)

PARAMETER	SYMBOL	TEST CONDITION	MIN.	TYP.	MAX.	UNIT
Output Voltage Accuracy	V_O	$I_O = 1\text{mA}$ $I_O = 1 \text{ to } 600\text{mA}$	-1.5 -3		+1.5 +2	%
Adjustable Voltage	V_{ADJ}	$I_O = 1\text{mA}$ $I_O = 1 \text{ to } 600\text{mA}$	1.251 1.232	1.27	1.289 1.295	V
line Regulation	ΔV_{LINE}	$I_O = 1\text{mA}$, $(V_{OUT}+1\text{V}) < V_{IN} < 6.5\text{V}$	-0.3	0.05	0.3	%/V
Load Regulation ^(Note 1)	ΔV_{LOAD}	$1\text{mA} \leq I_O \leq 600\text{mA}$, $C_{OUT} = 1\mu\text{F}$		0.5	1.5	%
Dropout Voltage	V_{DROP}	$V_{OUT} > 2.8\text{V}$, $I_O = 600\text{mA}$		600	1000	mV
		$2.0\text{V} < V_{OUT} \leq 2.8\text{V}$, $I_O = 600\text{mA}$		900	1400	
		$V_{OUT} \leq 2.0\text{V}$, $I_O = 600\text{mA}$		1300	1900	
Maximum Output Current	$I_{O(MAX)}$	$V_{OUT} > 0.96 \cdot V_{Rating}$	600			mA
Current Limit	I_{CL}			1300		mA
EN Exit Delay		$C_{BP} = 0\mu\text{F}$, $C_{OUT} = 1\mu\text{F}$ $I_O = 100\text{mA}$		600		usec
EN Input Bias Current		$V_{EN} = \text{GND}$			100	nA
EN Input Low Current		$V_{EN} = V_{IN}$	-1	-0.3		uA
EN Supply Current		$V_{EN} = V_{IN}$		0.01	1	uA
EN Input Threshold Low	V_{IL}	$V_{IN} = 2.5 \text{ to } 5.5\text{V}$			0.4	V
EN Input Threshold High	V_{IH}	$V_{IN} = 2.5 \text{ to } 5.5\text{V}$	2			V
Ground Pin Current	I_{GND}	$I_{OUT} = 0\text{mA to } 600\text{mA}$		50	85	uA
	I_{GND_OFF}	$V_{EN} = 0\text{V}$	-	-	1	uA
Thermal Shutdown Temperature	T_{SD}	$I_{OUT} = 10\text{mA}$		155		$^\circ\text{C}$
Thermal Shutdown Hysteresis	ΔT_{SD}	$I_{OUT} = 10\text{mA}$		10		$^\circ\text{C}$
V_O Temperature Coefficient		$I_{OUT} = 10\text{mA}$		30		ppm
Power Supply Ripple Rejection	PSRR	$I_{OUT} = 100\text{mA}$, $C_{OUT} = 2.2\mu\text{F}$, $f = 100\text{Hz}$		55		dB

Note 1. Load Regulation is measured using pulse techniques with duty cycle < 5%

TYPICAL OPERATING CHARACTERISTICS

- VIN = 3.3V, VOUT = 2.5V

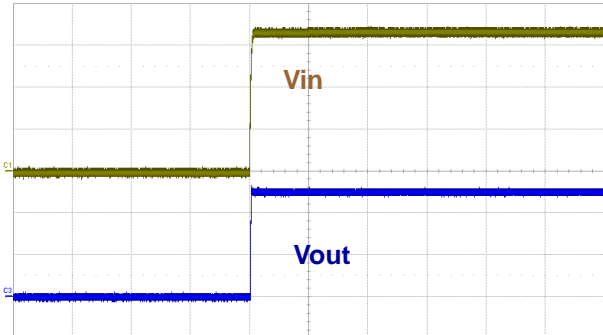

VIN : 1.0V/div, VOUT : 1.0V/div, Time : 10ms/div

Start Up @ Iout=0.3A
(Cin=10uF, Cout=10uF, R2=36KΩ, R1=35KΩ)

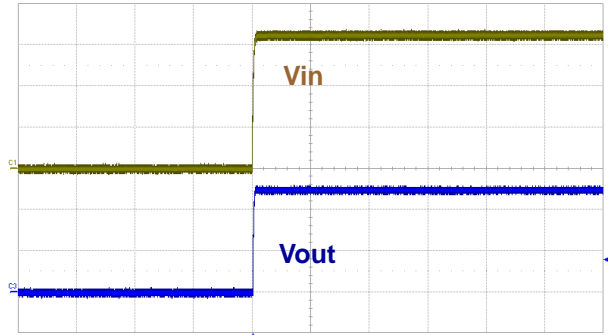

VIN : 1.0V/div, VOUT : 1.0V/div, Time : 10ms/div

Start Up @ Iout=0.6A
(Cin=10uF, Cout=10uF, R2=36KΩ, R1=35KΩ)

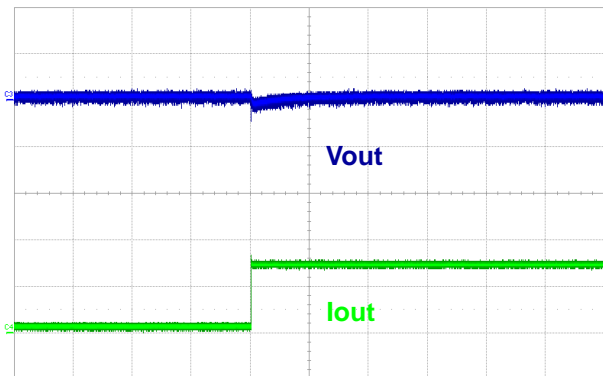

VOUT : 50mV/div, IOUT : 0.2A/div, Time : 50ms/div

Load Transient Response
(Cin=10uF, Cout=10uF, R2=36KΩ, R1=35KΩ)

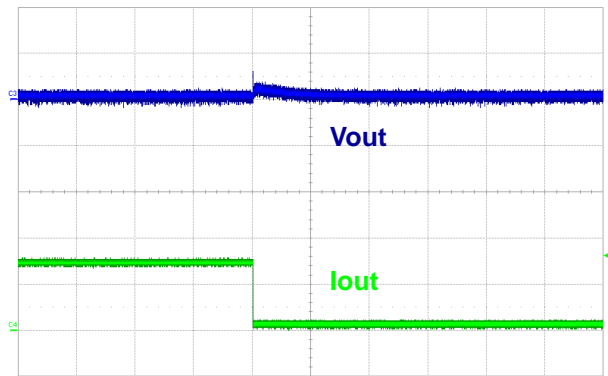

VOUT : 50mV/div, IOUT : 0.2A/div, Time : 50ms/div

Load Transient Response
(Cin=10uF, Cout=10uF, R2=36KΩ, R1=35KΩ)

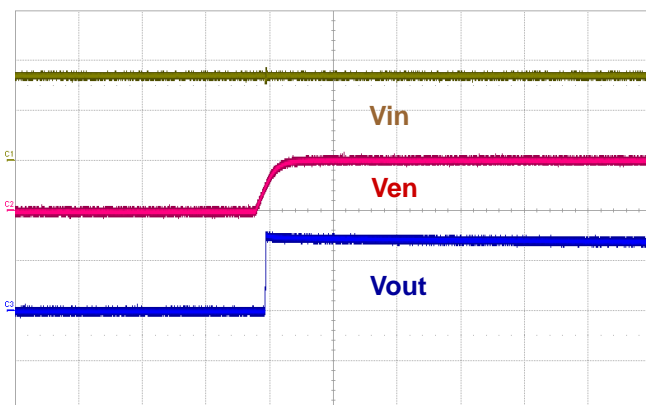

VIN : 2.0V/div, VEN : 2.0V, VOUT : 2.0V/div, Time : 1ms/div

Start Up by external VEN @ Iout=0A
(Cin=10uF, Cout=10uF, R2=36KΩ, R1=35KΩ)

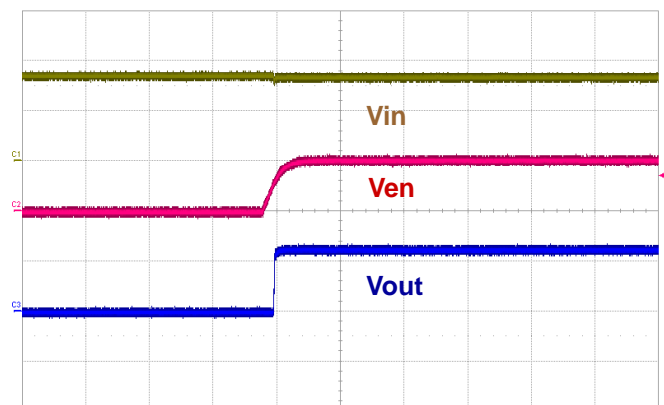

VIN : 2.0V/div, VEN : 2.0V, VOUT : 2.0V/div, Time : 1ms/div

Start Up by external VEN @ Iout=0.6A
(Cin=10uF, Cout=10uF, R2=36KΩ, R1=35KΩ)

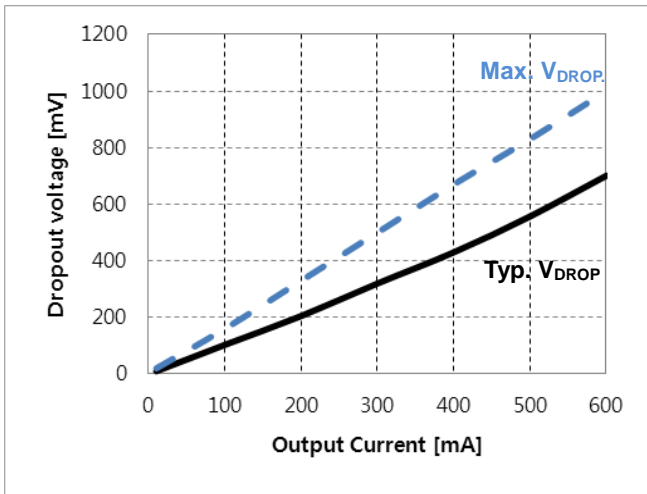

Dropout Voltage @ $V_{out}=3.3V$

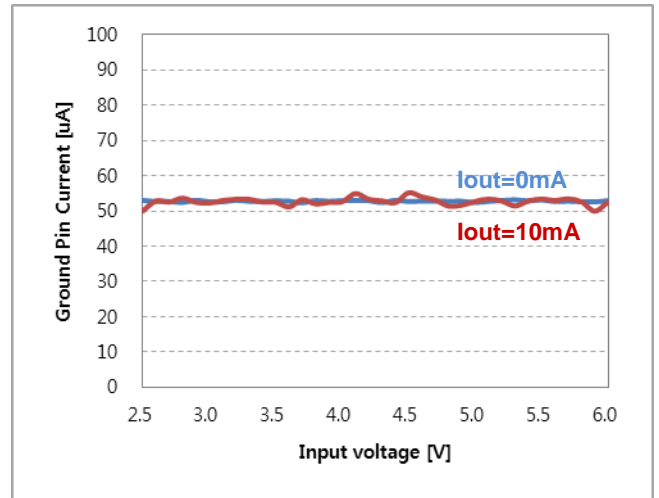

Ground Current @ $I_{out}=0A / 10mA$
($C_{in}=10\mu F$, $C_{out}=10\mu F$, $R_2=36K\Omega$, $R_1=35K\Omega$)

APPLICATION INFORMATION

Detailed Description

The LM8805 consists of a high-precision voltage reference, an error correction circuit, and a current limited output driver. With good transient responses, output remains stable even during load changes. The SHDN input enables the output to be turned off, resulting in reduced power consumption.

The LM8805 incorporates both over-temperature and over-current protection.

External Capacitors

The LM8805 can stable work with cheap MLCC output Capacitor.

The LM8805 having high ripple rejection ratios, the series can be used with power supply noise. A 470pF capacitor from the Bypass input to ground reduces noise present on the internal reference, which in turn significantly reduces output noise. If output noise is not a concern, this input may be left unconnected. Larger capacitor values C_{bp} be used, but results in a longer time period to rated output voltage when power is initially applied.

Output Adjustment (Adjustable Version)

The operating condition of V_{IN} and the operating characteristics of V_{OUT} depend on the dropout voltage performance in accordance with output load current.

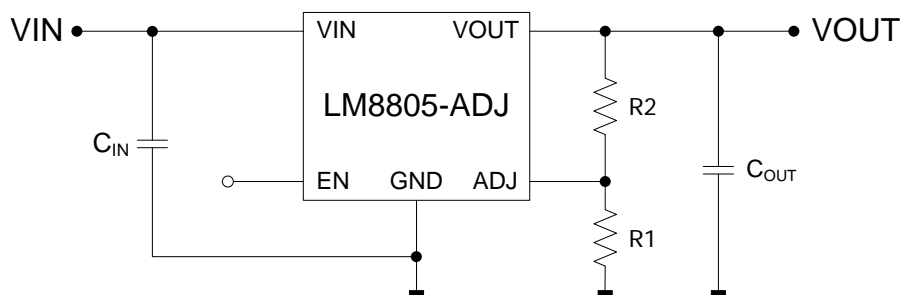

$$V_{OUT} = V_{ADJ}(1+R2/R1)$$

Maximum Output Current Capability

The LM8805 can deliver a continuous current of 600mA over the full operating junction temperature range. However, the output current is limited by the restriction of power dissipation which differs from packages. A heat sink may be required depending on the maximum power dissipation and maximum ambient temperature of application. With respect to the applied package, the maximum output current of 600mA may be still undeliverable due to the restriction of the power dissipation of LM8805. Under all possible conditions, the junction temperature must be within the range specified under operating conditions.

The temperatures over the device are given by:

$$\begin{aligned}T_C &= T_A + P_D \times \theta_{CA} \\T_J &= T_C + P_D \times \theta_{JC} \\T_J &= T_A + P_D \times \theta_{JA}\end{aligned}$$

where T_J is the junction temperature, T_C is the case temperature, T_A is the ambient temperature, P_D is the total power dissipation of the device, θ_{CA} is the thermal resistance of case-to-ambient, θ_{JC} is the thermal resistance of junction-to-case, and θ_{JA} is the thermal resistance of junction to ambient.

The total power dissipation of the device is given by:

$$\begin{aligned}P_D &= P_{IN} - P_{OUT} = (V_{IN} \times I_{IN}) - (V_{OUT} \times I_{OUT}) \\&= (V_{IN} \times (I_{OUT} + I_{GND})) - (V_{OUT} \times I_{OUT}) = (V_{IN} - V_{OUT}) \times I_{OUT} + V_{IN} \times I_{GND}\end{aligned}$$

where I_{GND} is the operating ground current of the device which is specified at the Electrical Characteristics. The maximum allowable temperature rise (T_{Rmax}) depends on the maximum ambient temperature (T_{Amax}) of the application, and the maximum allowable junction temperature (T_{Jmax}):

$$T_{Rmax} = T_{Jmax} - T_{Amax}$$

The maximum allowable value for junction-to-ambient thermal resistance, θ_{JA} , can be calculated using the formula:

$$\theta_{JA} = T_{Rmax} / P_D$$

REVISION NOTICE

The description in this datasheet is subject to change without any notice to describe its electrical characteristics properly.