

## FEATURES

- Ultra-Low Dropout Voltage
- Compatible with low ESR MLCC as Input / Output Capacitor
- Good Line and Load Regulation
- Guaranteed Output Current of 300mA
- Adjustable Output Voltage up to 5.0V
- Output Auto Discharge Function
- Over-Temperature/Over-Current Protection
- Available in SOT-23-6L Package

## APPLICATIONS

- LCD TVs and SETTOP Boxes
- Battery Powered Equipment
- Motherboards and Graphic Cards
- Microprocessor Power Supplies
- Peripheral Cards
- High Efficiency Linear Regulators
- Battery Chargers

## DESCRIPTION

The TPS73001 of high performance ultra-low dropout linear regulator operates from 2.5V to 6.0V input supply and provides ultra-low dropout voltage, high output current with low ground current. Wide range of preset output voltage options are available. These ultra-low dropout linear regulators respond fast to step changes in load which makes them suitable for low voltage micro-processor applications. The TPS73001 is developed on a CMOS process technology which allows low quiescent current operation independent of output load current. This CMOS process also allows the TPS73001 to operate under extremely low dropout conditions.



## ORDERING INFORMATION

Device	Package
TPS73001SF6	SOT-23-6L

**ABSOLUTE MAXIMUM RATINGS** (Note 1)

CHARACTERISTIC	SYMBOL	MIN	MAX	UNIT
Input Supply Voltage (Survival)	$V_{IN}$	-0.3	6.5	V
Enable Input Voltage (Survival)	$V_{EN}$	-0.3	$V_{IN} + 0.3$	V
Output Voltage (Survival)	$V_{OUT}$	-0.3	$V_{IN} + 0.3$	V
Maximum Output Current	$I_{MAX}$	-	300	mA
Operating Junction Temperature Range	$T_{JOPR}$	-40	125	°C
Storage Temperature Range	$T_{STG}$	-65	150	°C
Package Thermal Resistance*	$\Theta_{JA-SOT-23-6}$	265		°C/W
	$\Theta_{JC-SOT-23-6}$	130		°C/W

\* Calculated from package in still air, mounted to minimum foot print 2 layer PCB without thermal via per JE51 standards.

**RECOMMENDED OPERATING RATINGS** (Note 2)

CHARACTERISTIC	SYMBOL	MIN	MAX	UNIT
Input Supply Voltage	$V_{IN}$	2.5	6.0	V
Enable Input Voltage	$V_{EN}$	0	$V_{IN}$	V

**ORDERING INFORMATION**

Package	Order No.	Description	Supplied As	Status
SOT-23-6L	TPS73001SF6	300mA, Adjustable, Enable	Tape & Reel	Active

## PIN CONFIGURATION

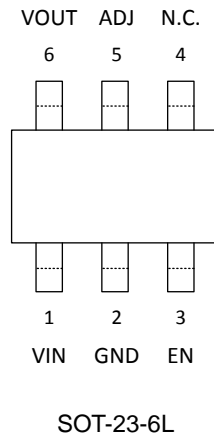

## PIN DESCRIPTION

Pin No.	Pin Name	Pin Function
1	VIN	Input Supply.
2	GND	Ground.
3	EN	Chip Enable. Do Not Float.
4	N.C.	No Connection.
5	ADJ	Output Adjust.
6	VOUT	Output Voltage.

## BLOCK DIAGRAM

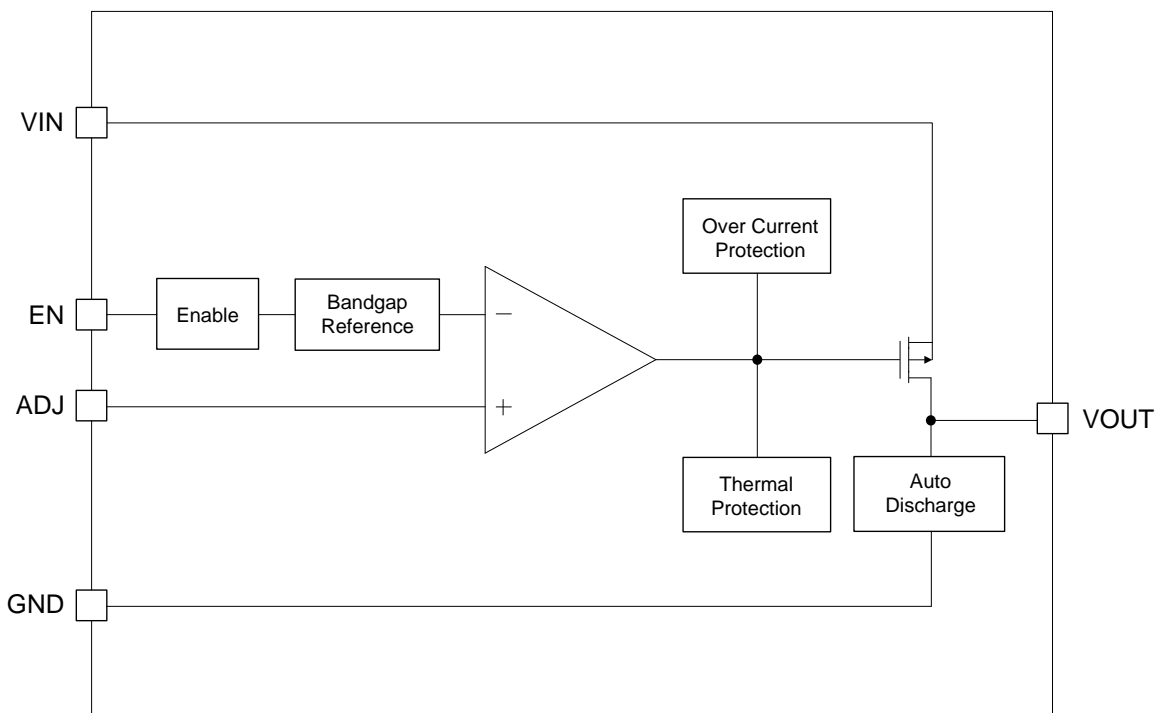

## TYPICAL APPLICATION CIRCUIT

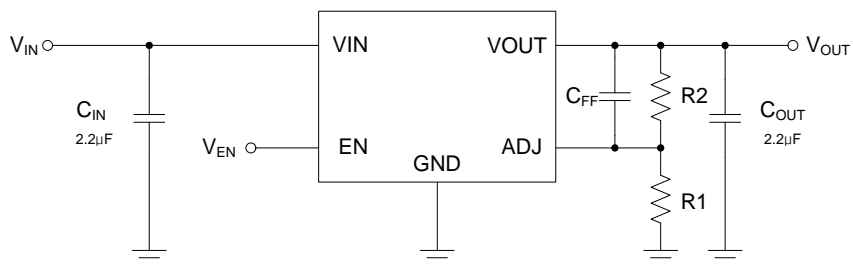

**ELECTRICAL CHARACTERISTICS** (Note 3)

Limits in standard typeface are for  $T_J = 25^\circ\text{C}$ , and limits in **boldface type** apply over the **full operating temperature range**.

Unless otherwise specified:  $V_{IN}^{(Note\ 4)} = V_{O(NOM)} + 1.0\text{ V}$ ,  $I_L = 10\text{ mA}$ ,  $C_{IN} = 2.2\ \mu\text{F}$ ,  $C_{OUT} = 2.2\ \mu\text{F}$ ,  $V_{EN} = V_{IN} - 0.3\text{ V}$

PARAMETER	SYMBOL	TEST CONDITIONS	MIN	TYP	MAX	UNIT	
Output Voltage Tolerance	$V_O$	$V_{OUT} + 1.0\text{ V} < V_{IN} < 6.0\text{ V}$	-2 -3	0	2 3	%	
Adjustable Pin Voltage	$V_{ADJ}$	$2.5\text{ V} < V_{IN} < 6.0\text{ V}$	0.588 <b>0.582</b>	0.6	0.612 <b>0.618</b>	V	
Line Regulation <small>(Note 5)</small>	$\Delta V_{LINE}$	$V_{OUT} + 1.0\text{ V} < V_{IN} < 6.0\text{ V}$	-	0.25	-	%/V	
Load Regulation <small>(Note 5, 6)</small>	$\Delta V_{LOAD}$	$10\text{ mA} < I_L < 300\text{ mA}$	-	0.30	-	%	
Dropout Voltage <small>(Note 7)</small>	$V_{DROP}$	$I_L = 30\text{ mA}$	-	25	35 <b>45</b>	mV	
		$I_L = 200\text{ mA}$	-	135	200 <b>270</b>		
		$I_L = 300\text{ mA}$	-	200	300 <b>400</b>		
Ground Pin Current <small>(Note 8)</small>	$I_{GND}$	$I_L = 30\text{ mA}$	-	0.10	0.15 <b>0.20</b>	mA	
		$I_L = 300\text{ mA}$	-	0.15	0.23 <b>0.30</b>		
Ground Pin Current <small>(Note 9)</small>	$I_{GND\_OFF}$	$V_{EN} < 0.2\text{ V}$	-	0.1	- <b>1.0</b>	$\mu\text{A}$	
Power Supply Rejection Ratio	PSRR	$f = 1.0\text{ kHz}$	-	45	-	dB	
		$f = 1.0\text{ kHz}$ , $C_{FF} = 0.1\ \mu\text{F}$	-	60	-		
Thermal Shutdown Temperature	$T_{SD}$		-	165	-	$^\circ\text{C}$	
Thermal Shutdown Hysteresis	$\Delta T_{SD}$		-	20	-	$^\circ\text{C}$	
OCP Threshold Level	$I_{OCP}$		-	650	-	mA	
Auto Discharge Resistance	$R_{DS}$	$V_{IN} = 5.0\text{ V}$ , $V_{EN} = 0\text{ V}$	-	330	-	$\Omega$	
Enable threshold	Logic Low	$V_{IL}$	Output = Low	-	-	0.4	V
	Logic High	$V_{IH}$	Output = High	2.0	-	-	V
Enable Input Current	$I_{EN}$	$V_{EN} = V_{IN}$	-	0.1	- <b>1.0</b>	$\mu\text{A}$	

Note 1. Exceeding the absolute maximum ratings may damage the device.

Note 2. The device is not guaranteed to function outside its operating ratings.

Note 3. Stresses listed as the absolute maximum ratings may cause permanent damage to the device. These are for stress ratings. Functional operating of the device at these or any other conditions beyond those indicated in the operational sections of the specifications is not implied. Exposure to absolute maximum rating conditions for extended periods may

remain possibly to affect device reliability.

Note 4. The minimum operating value for input voltage is equal to either ( $V_{OUT,NOM} + V_{DROP}$ ) or 2.5 V, whichever is greater.

Note 5. Output voltage line regulation is defined as the change in output voltage from the nominal value due to change in the input line voltage. Output voltage load regulation is defined as the change in output voltage from the nominal value due to change in load current.

Note 6. Regulation is measured at constant junction temperature by using a 10 ms current pulse. Devices are tested for load regulation in the load range from 10 mA to 300 mA.

Note 7. Dropout voltage is defined as the minimum input to output differential voltage at which the output drops 2.0 % below the nominal value. Dropout voltage specification applies only to output voltages of 2.5 V and above. For output voltages below 2.5 V, the dropout voltage is nothing but the input to output differential, since the minimum input voltage is 2.5 V.

Note 8. Ground current, or quiescent current, is the difference between input and output currents. It's defined by  $I_{GND} = I_{IN} - I_{OUT}$  under the given loading condition. The total current drawn from the supply is the sum of the load current plus the ground pin current.

Note 9. Ground current, or standby current, is the input current drawn by a regulator when the output voltage is disabled by an enable signal.

## TYPICAL OPERATING CHARACTERISTICS

### TEST CIRCUIT

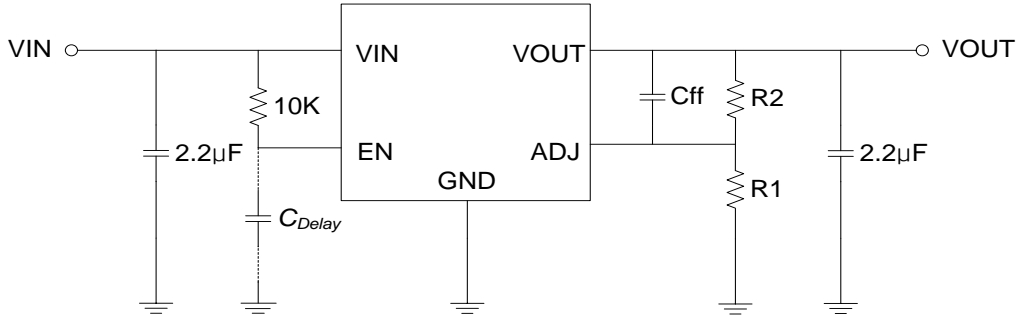

**VOUT = 1.2V ( VIN = 2.5V, R1 = 10KΩ, R2 = 10KΩ )**

VOUT = 1.2V ( Cff = 10nF )

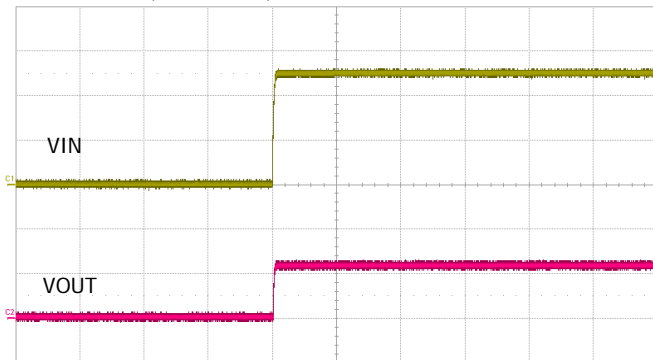

VIN : 1.0V/div, VOUT : 1.0V/div, Time : 10ms/div

Start Up @ Iout=0A

VOUT = 1.2V ( Cff = 10nF )

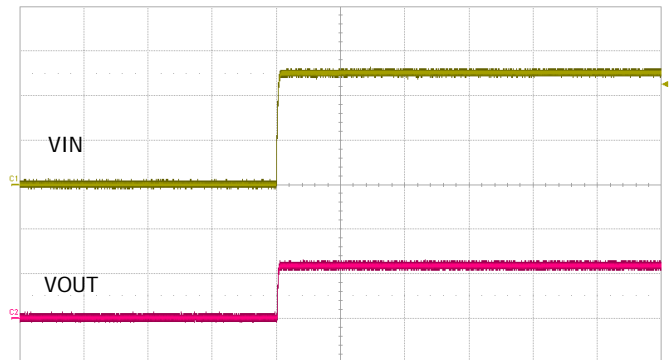

VIN : 1.0V/div, VOUT : 1.0V/div, Time : 10ms/div

Start Up @ Iout=300mA

VOUT = 1.2V ( Cff = 1µF )

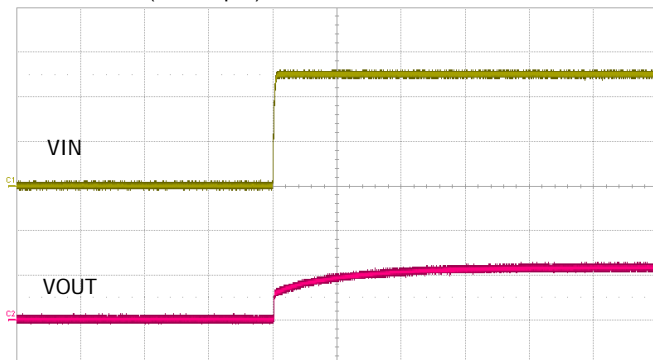

VIN : 1.0V/div, VOUT : 1.0V/div, Time : 10ms/div

Start Up @ Iout=0A

VOUT = 1.2V ( Cff = 1µF )

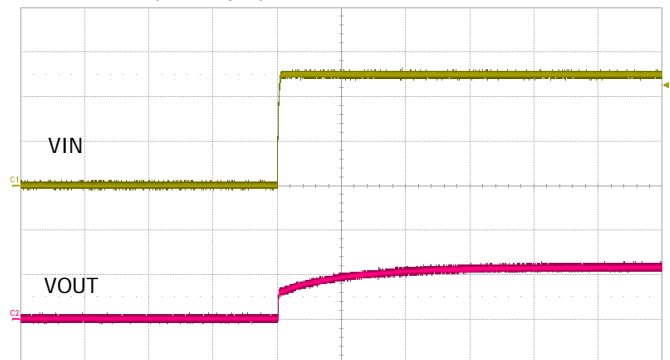

VIN : 1.0V/div, VOUT : 1.0V/div, Time : 10ms/div

Start Up @ Iout=300mA

VOUT = 1.2V ( Cff : varied )

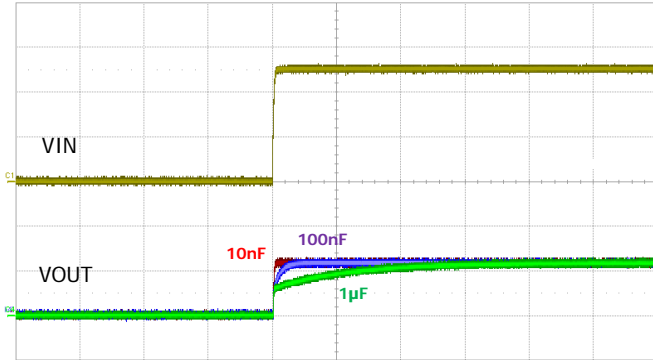

VIN : 1.0V/div, VOUT : 1.0V/div, Time : 10ms/div

Start Up @ Iout=10mA

VOUT = 1.2V ( Cdelay : varied, Cff = 10nF )

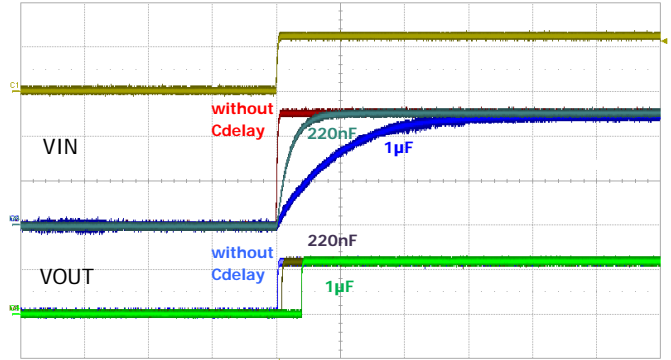

VIN : 2.0V/div, VEN : 1.0V/div, VOUT : 1.0V/div, Time : 10ms/div

Start Up with Cdelay @ Iout=10mA

VOUT = 1.2V ( Cff = 10nF )

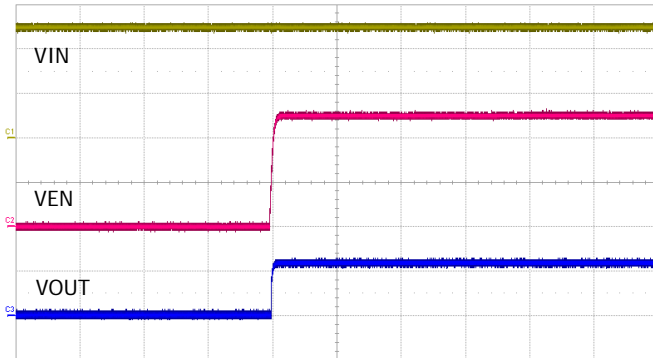

VIN : 1.0V/div, VEN : 1.0V/div, VOUT : 1.0V/div, Time : 5ms/div

Start Up by External VEN @ Iout=0A

VOUT = 1.2V ( Cff = 10nF )

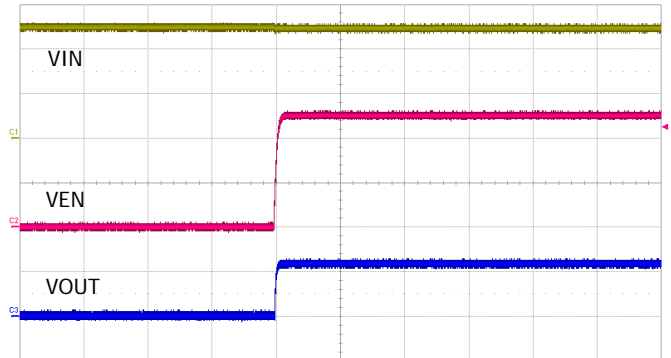

VIN : 1.0V/div, VEN : 1.0V/div, VOUT : 1.0V/div, Time : 5ms/div

Start Up by External VEN @ Iout=300mA

VOUT = 1.2V ( Cff = 10nF )

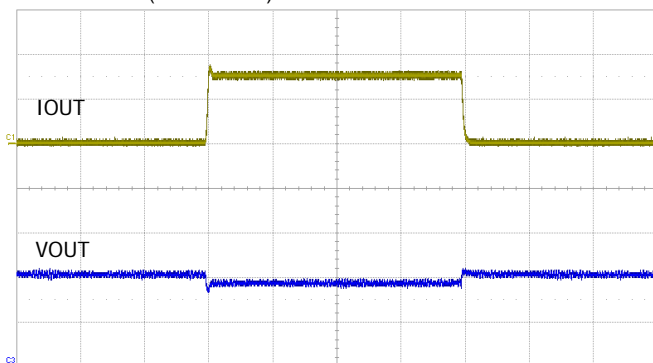

IOUT : 200mA/div, VOUT : 20mV/div, Time : 500µs/div

Load Transient Response



**VOUT = 3.3V ( VIN = 4.3V, R1 = 10K $\Omega$ , R2 = 45K $\Omega$  )**

VOUT = 3.3V ( Cff = 10nF )

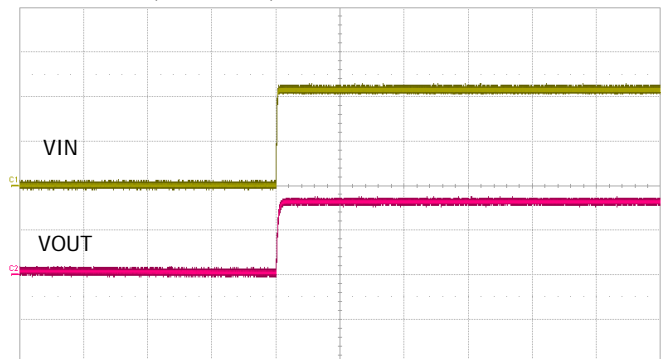

VIN : 2.0V/div, VOUT : 2.0V/div, Time : 20ms/div

Start Up @ Iout=0A

VOUT = 3.3V ( Cff = 10nF )

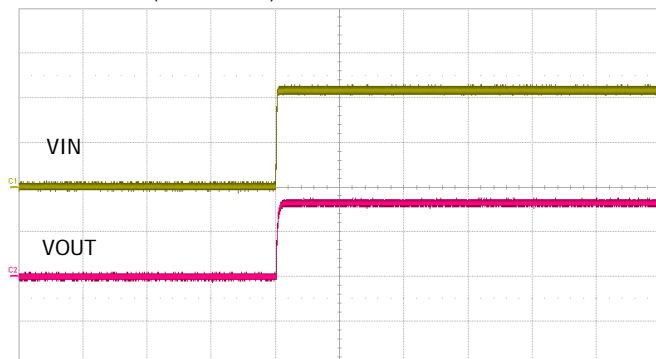

VIN : 2.0V/div, VOUT : 2.0V/div, Time : 20ms/div

Start Up @ Iout=300mA

VOUT = 3.3V ( Cff = 1 $\mu$ F )

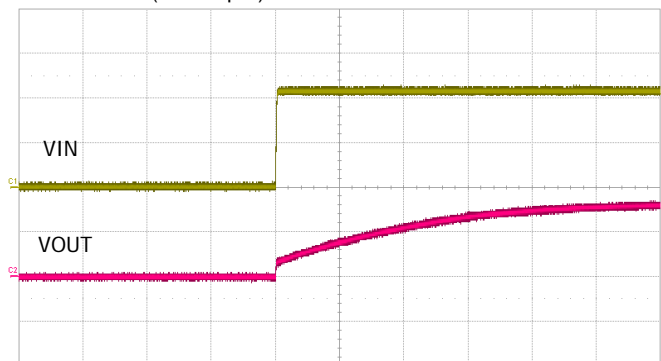

VIN : 2.0V/div, VOUT : 2.0V/div, Time : 20ms/div

Start Up @ Iout=0A

VOUT = 3.3V ( Cff = 1 $\mu$ F )

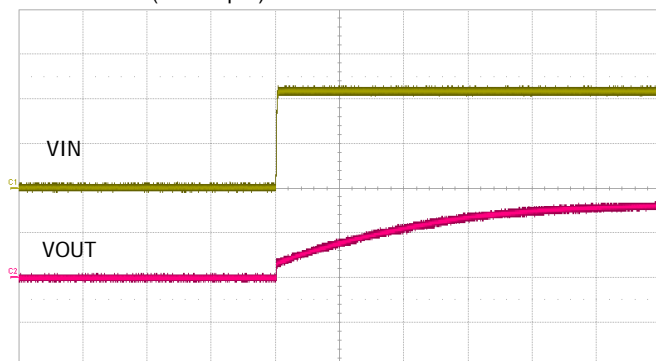

VIN : 2.0V/div, VOUT : 2.0V/div, Time : 20ms/div

Start Up @ Iout=300mA

VOUT = 3.3V ( Cff : varied )

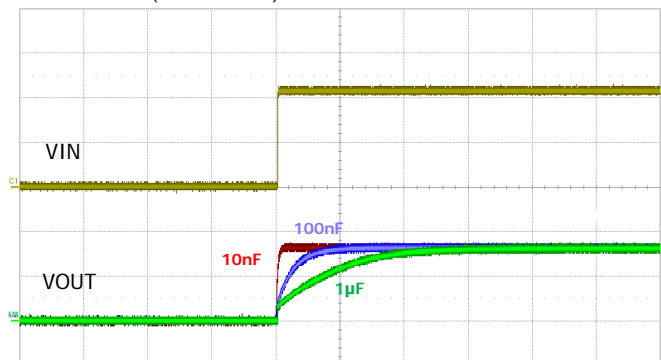

VIN : 2.0V/div, VOUT : 2.0V/div, Time : 50ms/div

Start Up @ Iout=10mA

VOUT = 3.3V ( Cdelay : varied, Cff = 10nF )

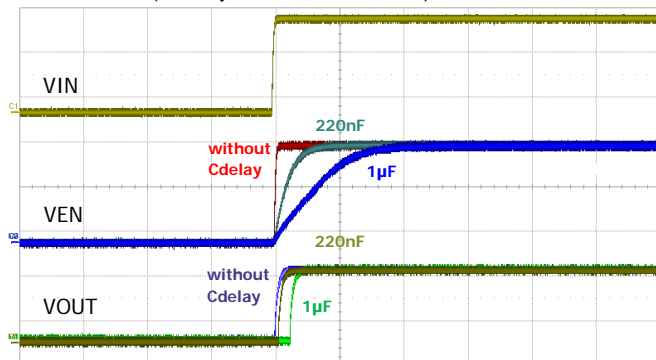

VIN : 2.0V/div, VEN : 2.0V/div, VOUT : 2.0V/div, Time : 10ms/div

Start Up with Cdelay @ Iout=10mA

VOUT = 3.3V ( Cff = 10nF )

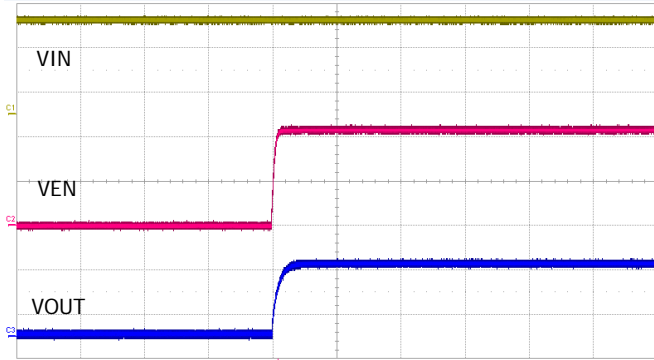

VIN : 2.0V/div, VEN : 2.0V/div, VOUT : 2.0V/div, Time : 5ms/div

Start Up by External VEN @ Iout=0A

VOUT = 3.3V ( Cff = 10nF )

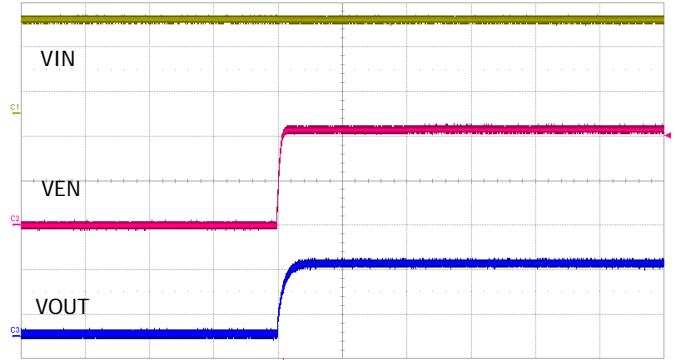

VIN : 2.0V/div, VEN : 2.0V/div, VOUT : 2.0V/div, Time : 5ms/div

Start Up by External VEN @ Iout=300mA

VOUT = 3.3V ( Cff = 10nF )

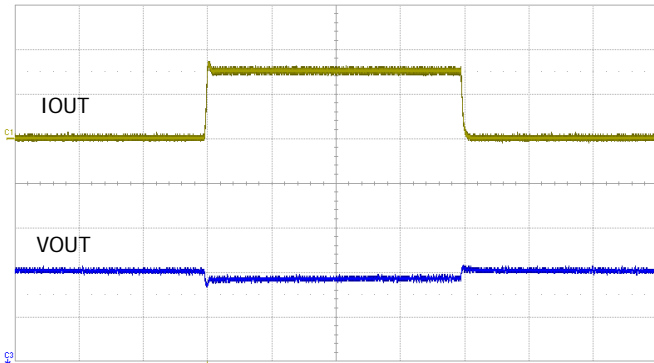

IOUT : 200mA/div, VOUT : 20mV/div, Time : 500µs/div

Load Transient Response

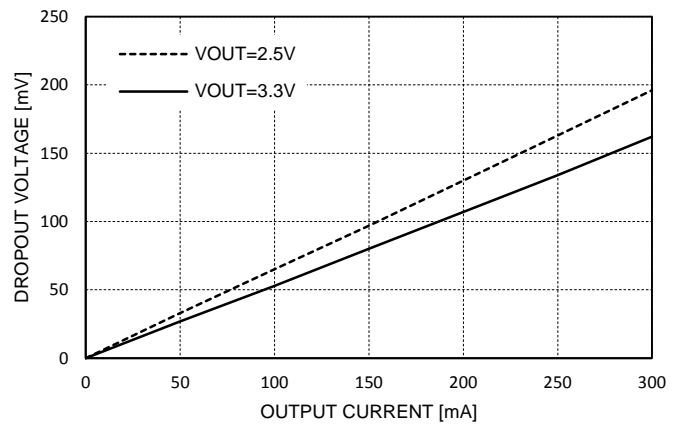

Dropout Voltage

## APPLICATION INFORMATION

### INTRODUCTION

TPS73001 is intended for applications where high current capability and very low dropout voltage are required. It provides a simple, low cost solution that occupies very little PCB area. Additional features include an enable pin to allow for a very low power consumption standby mode, an adjustable pin to provide a fully adjustable output voltage.

### COMPONENT SELECTION

#### Input Capacitor

A minimum of 2.2 $\mu$ F ceramic capacitor is recommended to be placed directly next to the  $V_{IN}$  Pin. It allows for the device being some distance from any bulk capacitor on the rail. Additionally, input droop due to load transients is reduced, improving load transient response. Additional capacitance may be added if required by the application (See Fig. 1).

#### Output Capacitor

A minimum ceramic capacitor over than 2.2 $\mu$ F should be very closely placed to the output voltage pin of the TPS73001. Increasing capacitance will improve the overall transient response and stability.

#### Decoupling (Bypass) Capacitor

In very electrically noisy environments, it is recommended that additional ceramic capacitors be placed from  $V_{IN}$  to GND. The use of multiple lower value ceramic capacitors in parallel with output capacitor also allows to achieve better transient performance and stability if required by the application (See Fig. 1).

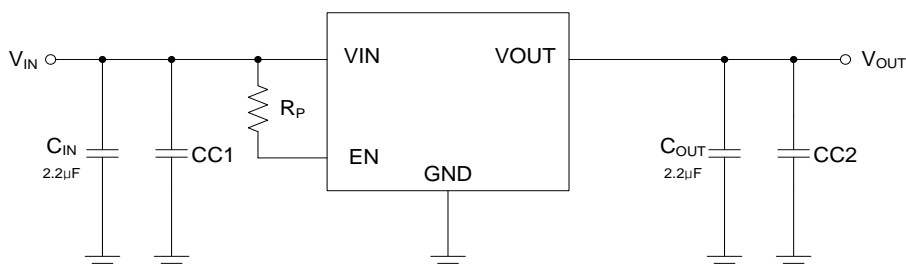

Fig. 1. Application with Decoupling Capacitor, CC1 & CC2

#### Feed-Forward Capacitor

To get the higher PSRR than the inherent performance of TPS73001, it is recommended that additional ceramic feed-forward capacitor be placed from VOUT pin to ADJ pin. The capacitance of feed-forward capacitor with range of 2.2nF to 1 $\mu$ F allows to achieve better PSRR performance when required by the application (See Fig. 2).

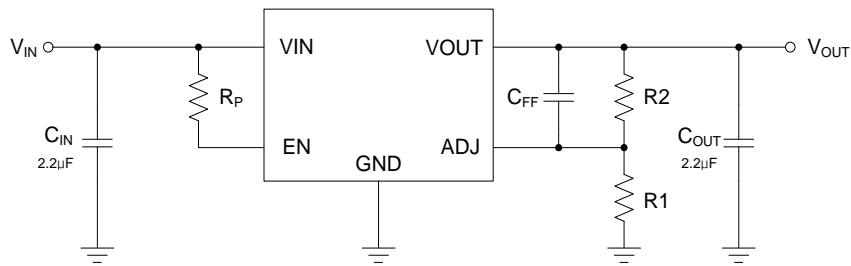

Fig. 2. Application with Feed-Forward Capacitor, CFF

## Delayed Start-Up

When power sequence control is required or rising time of input supply voltage is over than 100µsec, it is recommended to apply delayed start-up by using Cdelay as shown in Fig. 3. It can adjust proper delay by Rp-Cdelay time constant. And also it can prevent any unexpected transient characteristics at output voltage when the rising time of input supply voltage is as long as 100µsec or longer.

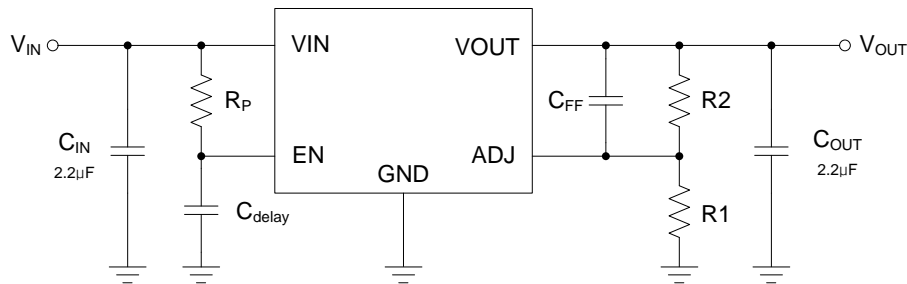
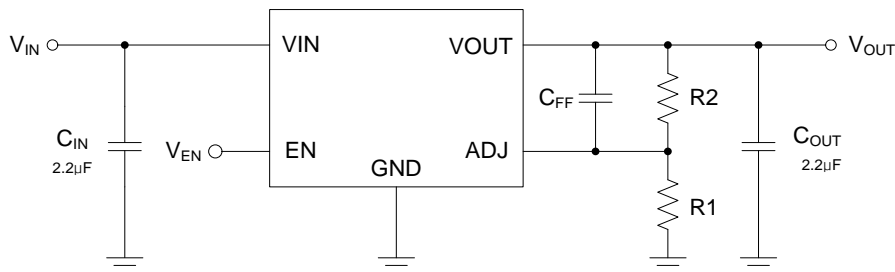

Fig. 3. Application with Delayed Start-Up

## OUTPUT ADJUSTMENT (ADJUSTABLE VERSION)

An adjustable output device has output voltage range of 1.0V to 5.0V. The operating condition of VIN and the operating characteristics of VOUT depend on the dropout voltage performance in accordance with output load current. To obtain a desired output voltage, the following equation can be used with R1 resistor range of 1kΩ to 100kΩ.



$$R2 = R1 \left( \frac{V_{OUT}}{0.6} - 1 \right)$$

Fig. 4. Application for Adjustable Output Voltage

To enhance output stability, a feed-forward capacitor of 2.2nF to 1µF can be placed in series with  $V_{OUT}$  and ADJ (Refer to "Component Selection" Section).

### AUTO DISCHARGE FUNCTION

The TPS73001 provides an auto discharge function that is used for faster discharging of the output capacitor. This function is automatically activated when the EN input goes into an active low state.

### MAXIMUM OUPUT CURRENT CAPABILITY

The TPS73001 can deliver a continuous current of 300mA over the full operating junction temperature range. However, the output current is limited by the restriction of power dissipation of package. With respect to the applied package, the maximum output current of 300mA may be still undeliverable due to the restriction of the power dissipation of TPS73001. Under all possible conditions, the junction temperature must be within the range specified under operating conditions.

The temperatures over the device are given by:

$$T_C = T_A + P_D \times \theta_{CA}$$

$$T_J = T_C + P_D \times \theta_{JC}$$

$$T_J = T_A + P_D \times \theta_{JA}$$

where  $T_J$  is the junction temperature,  $T_C$  is the case temperature,  $T_A$  is the ambient temperature,  $P_D$  is the total power dissipation of the device,  $\theta_{CA}$  is the thermal resistance of case-to-ambient,  $\theta_{JC}$  is the thermal resistance of junction-to-case, and  $\theta_{JA}$  is the thermal resistance of junction to ambient.

The total power dissipation of the device is given by:

$$\begin{aligned} P_D &= P_{IN} - P_{OUT} = (V_{IN} \times I_{IN}) - (V_{OUT} \times I_{OUT}) \\ &= (V_{IN} \times (I_{OUT} + I_{GND})) - (V_{OUT} \times I_{OUT}) = (V_{IN} - V_{OUT}) \times I_{OUT} + V_{IN} \times I_{GND} \end{aligned}$$

where  $I_{GND}$  is the operating ground current of the device which is specified at the Electrical Characteristics. The maximum allowable temperature rise ( $T_{Rmax}$ ) depends on the maximum ambient temperature ( $T_{Amax}$ ) of the application, and the maximum allowable junction temperature ( $T_{Jmax}$ ):

$$T_{Rmax} = T_{Jmax} - T_{Amax}$$

The maximum allowable value for junction-to-ambient thermal resistance,  $\theta_{JA}$ , can be calculated using the formula:

$$\theta_{JA} = T_{Rmax} / P_D$$

If proper cooling solution such as copper plane area or air flow is applied, the maximum allowable power dissipation could be increased. However, if the ambient temperature is increased, the allowable power dissipation would be decreased.

## REVISION NOTICE

The description in this datasheet is subject to change without any notice to describe its electrical characteristics properly.