

TOSHIBA Photocoupler GaAs Ired & Photo-Transistor

TLP185

Office Machine
 Programmable Controllers
 AC Adapter
 I/O Interface Board

Unit: mm

The TOSHIBA mini flat coupler TLP185 is a small outline coupler, suitable for surface mount assembly.

TLP185 consists of a photo transistor optically coupled to a gallium arsenide infrared emitting diode. Since TLP185 is smaller than DIP package, it's suitable for high-density surface mounting applications such as programmable controllers.

- Collector-emitter voltage: 80 V (min)
- Current transfer ratio: 50 % (min)
 Rank GB: 100% (min)
- Isolation voltage: 3750 Vrms (min)
- Operation Temperature: -55 to 110 °C
- Safety Standards
 UL approved: UL1577, File No. E67349
 cUL approved: CSA Component Acceptance Service No. 5A
 File No. E67349
- CQC approved: GB4943.1, GB8898 Japan and Thailand Factory
 仅适用于海拔 2000m 以下地区安全使用
- Option (V4) type
 VDE approved: EN60747-5-5, EN60065, EN60950-1 (Note 1)
 Under application EN62368-1
 Note 1: When a EN60747-5-5 approved type is needed,
 Please designate "Option(V4)"

- Construction mechanical rating
 Creepage distance : 5.0 mm (min)
 Clearance : 5.0 mm (min)
 Insulation thickness : 0.4 mm (min)

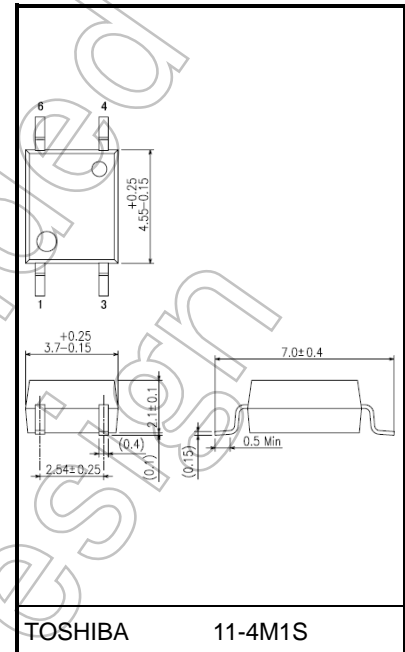

Weight: 0.08 g (typ.)

Pin Configuration (top view)

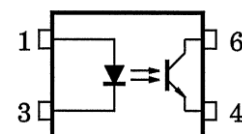

- 1: Anode
- 3: Cathode
- 4: Emitter
- 6: Collector

Start of commercial production
 2011-12

Current Transfer Ratio

Type	Classification (Note1)	Current Transfer Ratio (%) (I_C / I_F)		Marking Of Classification
		$I_F = 5 \text{ mA}, V_{CE} = 5 \text{ V}, T_a = 25^\circ\text{C}$		
		Min	Max	
TLP185	Blank	50	400	Blank, YE, GR, GB, Y+, G, G+, B
	Rank Y	50	150	YE, Y+
	Rank GR	100	300	GR, G, G+
	Rank GB	100	400	GB, GR, G, G+, BL, B,
	Rank YH	75	150	Y+
	Rank GRL	100	200	G
	Rank GRH	150	300	G+
	Rank BLL	200	400	B

Note1: Ex Rank GB: TLP185 (GB,E)

Note: Application, type name for certification test, please use standard product type name, i. e.
TLP185(GB,E: TLP185

Not Recommended for New Design

Absolute Maximum Ratings (Ta = 25°C)

Characteristic		Symbol	Rating	Unit
LED	Forward current	I _F	50	mA
	Forward current derating (Ta ≥ 90°C)	ΔI _F /°C	-1.5	mA/°C
	Pulse forward current (Note 1)	I _{FP}	1	A
	Reverse voltage	V _R	5	V
	Diode power dissipation	P _D	100	mW
	Diode power dissipation derating (Ta >90°C)	ΔP _D /°C	-2.9	mW/°C
	Junction temperature	T _j	125	°C
Detector	Collector-emitter voltage	V _{CEO}	80	V
	Emitter-collector voltage	V _{ECO}	7	V
	Collector current	I _C	50	mA
	Collector power dissipation	P _C	150	mW
	Collector power dissipation derating (Ta ≥ 25°C)	ΔP _C /°C	-1.5	mW/°C
	Junction temperature	T _j	125	°C
Operating temperature range		T _{opr}	-55 to 110	°C
Storage temperature range		T _{stg}	-55 to 125	°C
Lead soldering temperature (10 s)		T _{sol}	260	°C
Total package power dissipation		P _T	200	mW
Total package power dissipation derating (Ta ≥ 25°C)		ΔP _T /°C	-2.0	mW/°C
Isolation voltage (AC, 60 s, R.H. ≤ 60%) (Note 2)		BV _S	3750	V _{rms}

Note: Using continuously under heavy loads (e.g. the application of high temperature/current/voltage and the significant change in temperature, etc.) may cause this product to decrease in the reliability significantly even if the operating conditions (i.e. operating temperature/current/voltage, etc.) are within the absolute maximum ratings.

Please design the appropriate reliability upon reviewing the Toshiba Semiconductor Reliability Handbook ("Handling Precautions"/"Derating Concept and Methods") and individual reliability data (i.e. reliability test report and estimated failure rate, etc).

Note 1: Pulse width ≤ 100 μs, f = 100 Hz

Note 2: Device considered a two terminal device: Pins 1 and 3 shorted together and 4 and 6 shorted together.

Recommended Operating Conditions

Characteristic	Symbol	Min	Typ.	Max	Unit
Supply voltage	V _{CC}	—	5	48	V
Forward current	I _F	—	16	20	mA
Collector current	I _C	—	1	10	mA

Note: Recommended operating conditions are given as a design guideline to obtain expected performance of the device. Additionally, each item is an independent guideline respectively. In developing designs using this product, please confirm specified characteristics shown in this document.

Electrical Characteristics (Ta = 25°C)

Characteristic		Symbol	Test Condition	Min	Typ.	Max	Unit
LED	Forward voltage	V _F	I _F = 10 mA	1.1	1.25	1.4	V
	Reverse current	I _R	V _R = 5 V	—	—	5	μA
	Capacitance	C _T	V = 0 V, f = 1 MHz	—	30	—	pF
Detector	Collector-emitter breakdown voltage	V _{(BR)CEO}	I _C = 0.5 mA	80	—	—	V
	Emitter-collector breakdown voltage	V _{(BR)ECO}	I _E = 0.1 mA	7	—	—	V
	Collector dark current	I _{CEO}	V _{CE} = 48 V	—	0.01	0.08	μA
			V _{CE} = 48 V, Ta = 85°C	—	2	50	μA
Capacitance (collector to emitter)	C _{CE}	V = 0 V, f = 1 MHz	—	10	—	pF	

Coupled Electrical Characteristics (Ta = 25°C)

Characteristic	Symbol	Test Condition	Min	Typ.	Max	Unit
Current transfer ratio	I _C /I _F	I _F = 5 mA, V _{CE} = 5 V Rank GB	50	—	400	%
			100	—	400	
Saturated CTR	I _C /I _{F(sat)}	I _F = 1 mA, V _{CE} = 0.4 V Rank GB	—	60	—	%
			30	—	—	
Collector-emitter saturation voltage	V _{CE(sat)}	I _C = 2.4 mA, I _F = 8 mA	—	—	0.3	V
		I _C = 0.2 mA, I _F = 1 mA Rank GB	—	0.2	—	
			—	—	0.3	
Off-state collector current	I _{C(off)}	V _F = 0.7 V, V _{CE} = 48 V	—	1	10	μA

Isolation Characteristics (Ta = 25°C)

Characteristic	Symbol	Test Condition	Min	Typ.	Max	Unit
Capacitance (input to output)	C _S	V _S = 0 V, f = 1 MHz	—	0.8	—	pF
Isolation resistance	R _S	V _S = 500 V, R.H. ≤ 60%	1×10 ¹²	10 ¹⁴	—	Ω
Isolation voltage	BV _S	AC, 60 s	3750	—	—	V _{rms}
		AC, 1 s, in oil	—	10000	—	V _{dc}
		DC, 60 s, in oil	—	10000	—	

Switching Characteristics (Ta = 25°C)

Characteristic	Symbol	Test Condition	Min	Typ.	Max	Unit
Rise time	t_r	$V_{CC} = 10\text{ V}$, $I_C = 2\text{ mA}$ $R_L = 100\ \Omega$	—	5	—	μs
Fall time	t_f		—	9	—	
Turn-on time	t_{on}		—	9	—	
Turn-off time	t_{off}		—	9	—	
Turn-on time	t_{on}	$R_L = 1.9\text{ k}\Omega$ $V_{CC} = 5\text{ V}$, $I_F = 16\text{ mA}$ (Fig.1)	—	2	—	μs
Storage time	t_s		—	30	—	
Turn-off time	t_{off}		—	70	—	

Fig. 1 Switching time test circuit

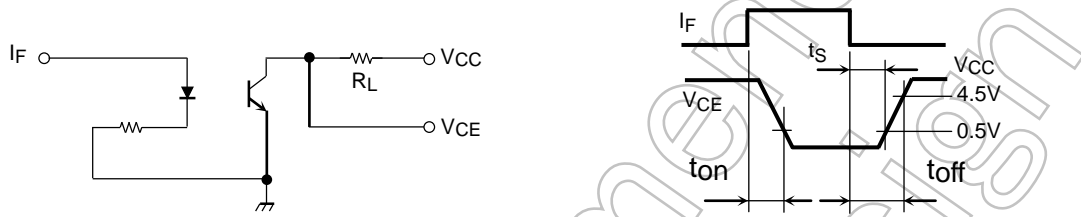

Not Recommended for New Design

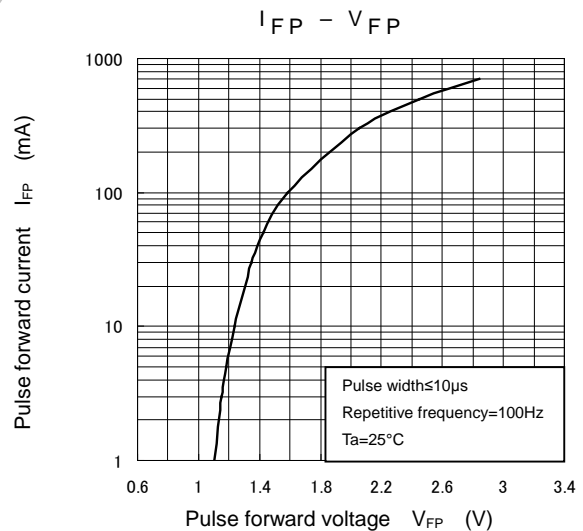
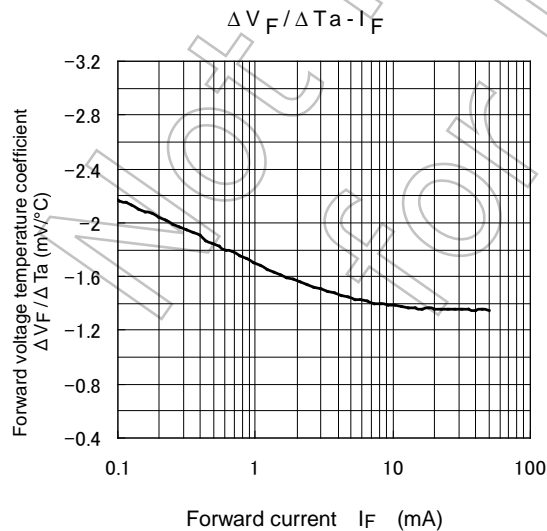
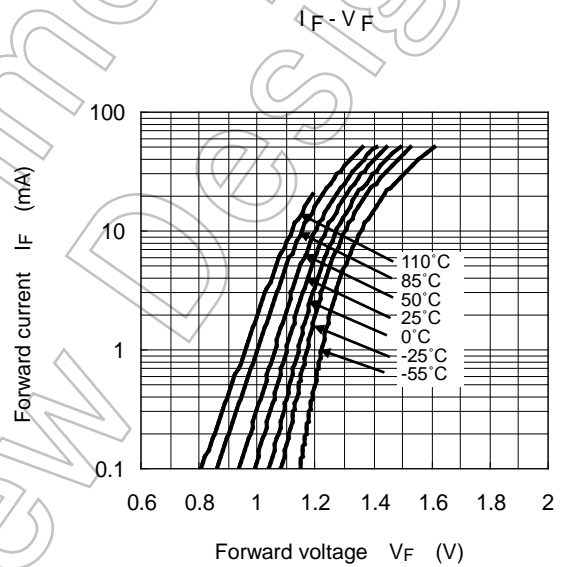
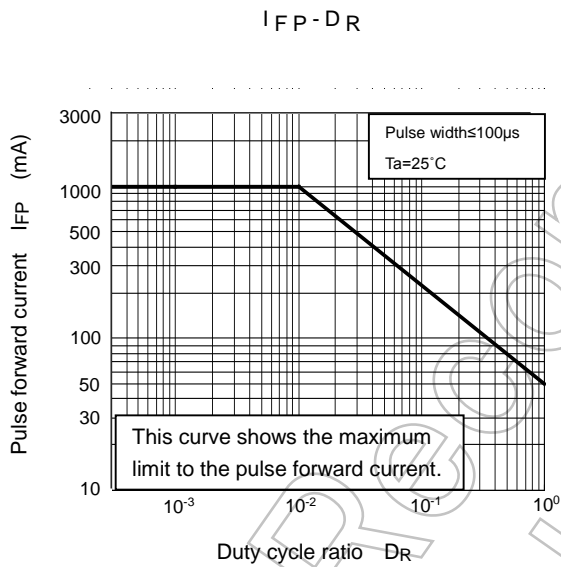
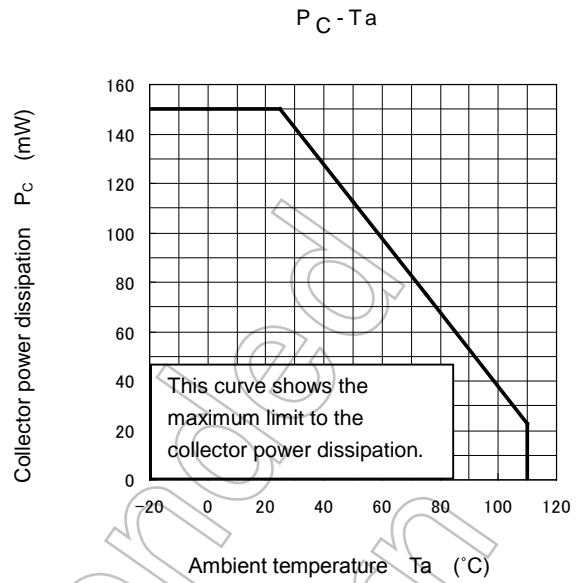
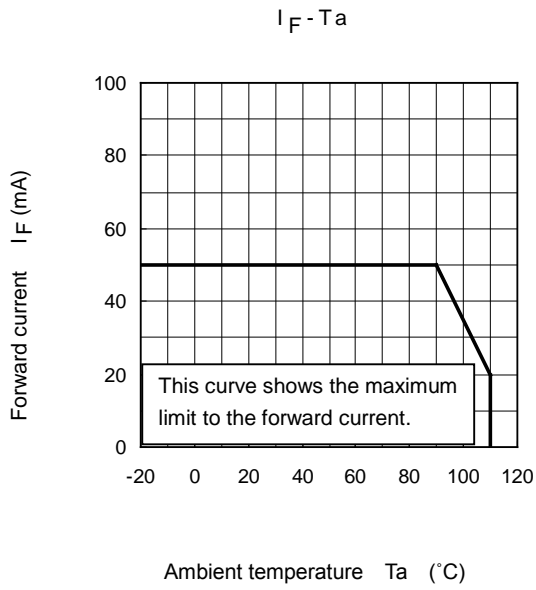

*The above graphs show typical characteristic.

$I_C - V_{CE}$

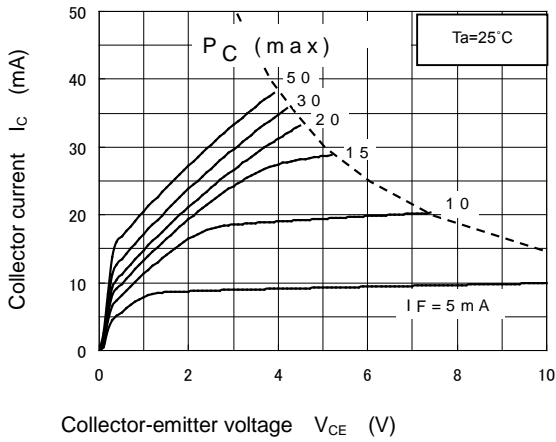

$I_C - V_{CE}$

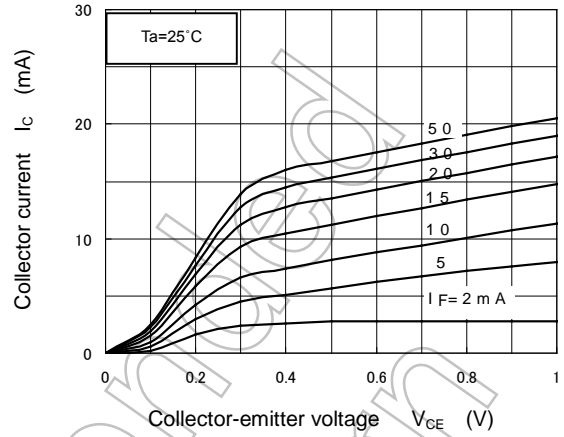

$I_C - I_F$

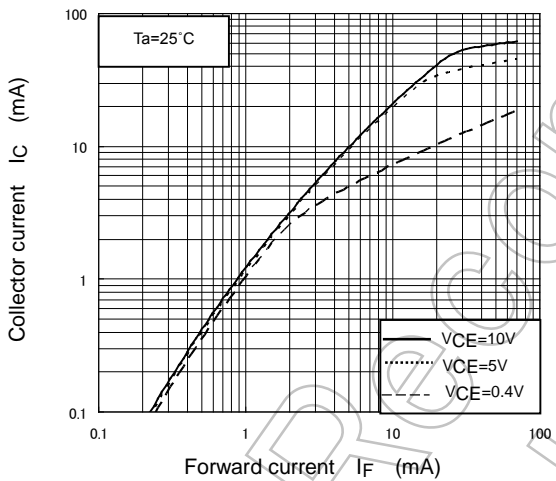

$I_{CE0} - T_a$

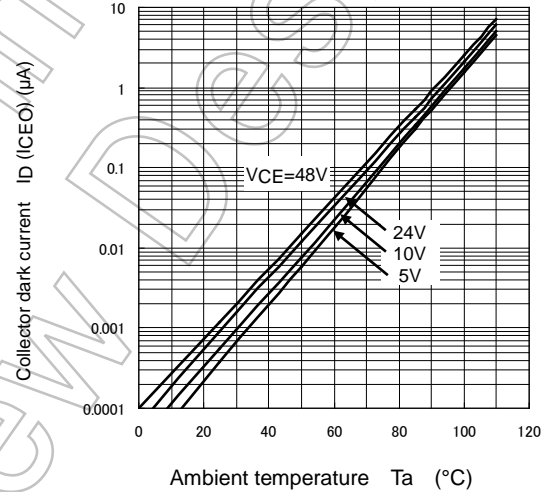

$I_C / I_F - I_F$

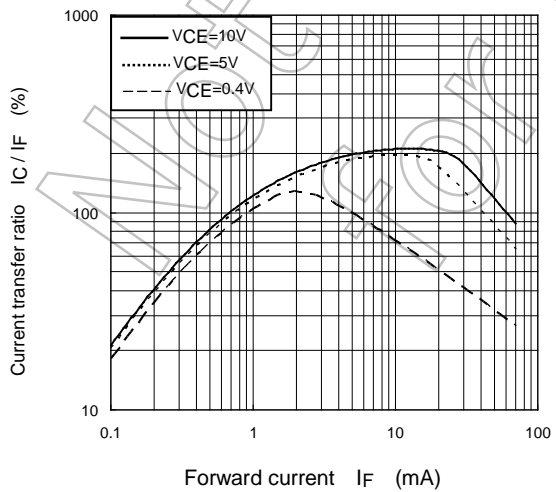

*The above graphs show typical characteristic.

$V_{CE(sat)} - T_a$

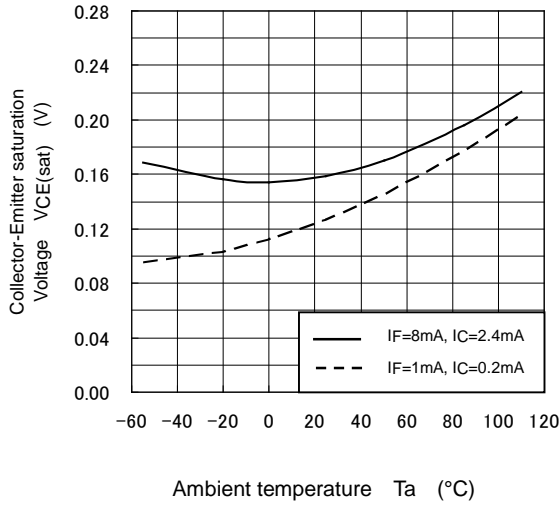

$I_C - T_a$

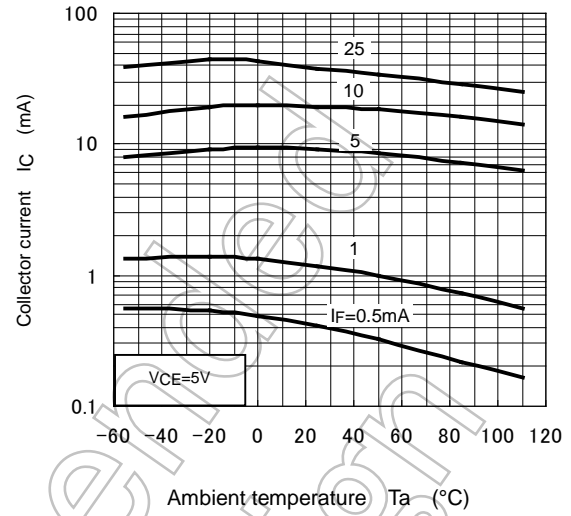

Switching time - R_L

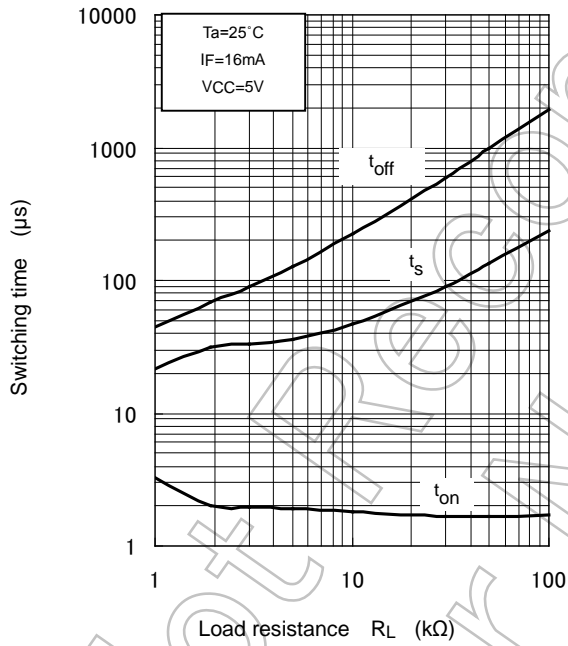

Switching time - T_a

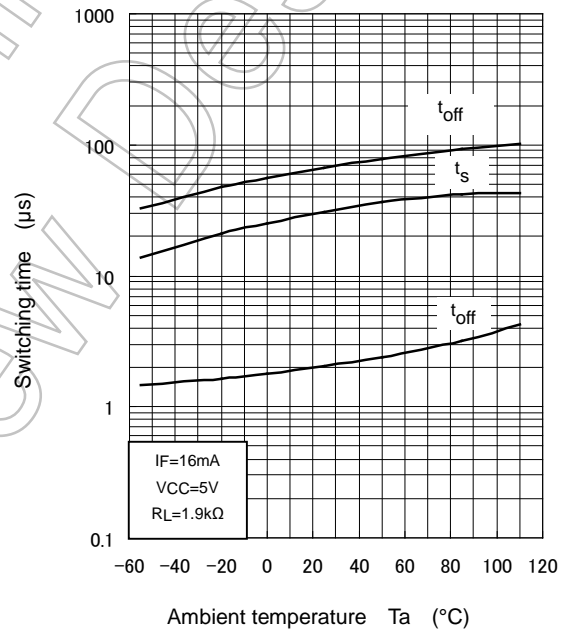

*The above graphs show typical characteristic.

Soldering and Storage

1. Soldering

1.1 Soldering

When using a soldering iron or medium infrared ray/hot air reflow, avoid a rise in device temperature as much as possible by observing the following conditions.

1) Using solder reflow

·Temperature profile example of lead (Pb) solder

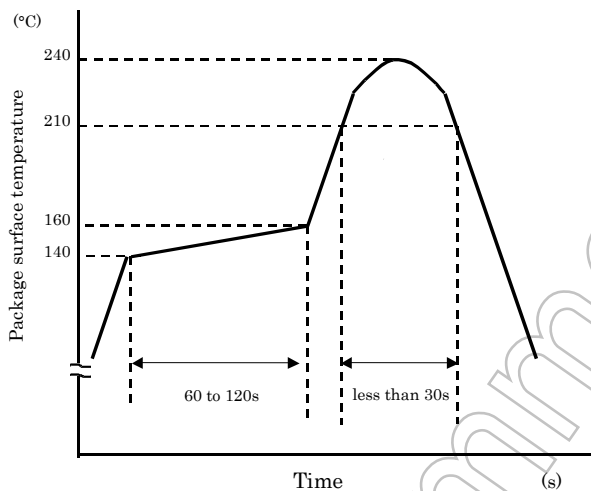

This profile is based on the device's maximum heat resistance guaranteed value.

Set the preheat temperature/heating temperature to the optimum temperature corresponding to the solder paste type used by the customer within the described profile.

·Temperature profile example of using lead (Pb)-free solder

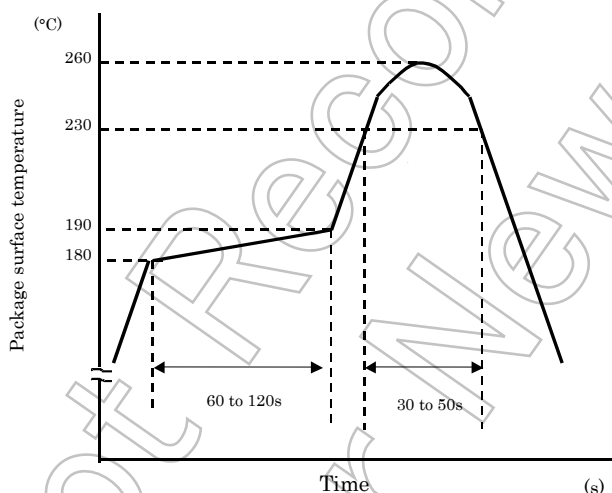

This profile is based on the device's maximum heat resistance guaranteed value.

Set the preheat temperature/heating temperature to the optimum temperature corresponding to the solder paste type used by the customer within the described profile.

Reflow soldering must be performed once or twice.

The mounting should be completed with the interval from the first to the last mountings being 2 weeks.

2) Using solder flow (for lead (Pb) solder, or lead (Pb)-free solder)

Please preheat it at 150°C between 60 and 120 seconds.

Complete soldering within 10 seconds below 260°C. Each pin may be heated at most once.

3) Using a soldering iron

Complete soldering within 10 seconds below 260°C, or within 3 seconds at 350°C. Each pin may be heated at most once.

2. Storage

- 1) Avoid storage locations where devices may be exposed to moisture or direct sunlight.
- 2) Follow the precautions printed on the packing label of the device for transportation and storage.
- 3) Keep the storage location temperature and humidity within a range of 5°C to 35°C and 45% to 75%, respectively.
- 4) Do not store the products in locations with poisonous gases (especially corrosive gases) or in dusty conditions.
- 5) Store the products in locations with minimal temperature fluctuations. Rapid temperature changes during storage can cause condensation, resulting in lead oxidation or corrosion, which will deteriorate the solderability of the leads.
- 6) When restoring devices after removal from their packing, use anti-static containers.
- 7) Do not allow loads to be applied directly to devices while they are in storage.
- 8) If devices have been stored for more than two years under normal storage conditions, it is recommended that you check the leads for ease of soldering prior to use.

Not Recommended
for New Design

RESTRICTIONS ON PRODUCT USE

- Toshiba Corporation, and its subsidiaries and affiliates (collectively "TOSHIBA"), reserve the right to make changes to the information in this document, and related hardware, software and systems (collectively "Product") without notice.
- This document and any information herein may not be reproduced without prior written permission from TOSHIBA. Even with TOSHIBA's written permission, reproduction is permissible only if reproduction is without alteration/omission.
- Though TOSHIBA works continually to improve Product's quality and reliability, Product can malfunction or fail. Customers are responsible for complying with safety standards and for providing adequate designs and safeguards for their hardware, software and systems which minimize risk and avoid situations in which a malfunction or failure of Product could cause loss of human life, bodily injury or damage to property, including data loss or corruption. Before customers use the Product, create designs including the Product, or incorporate the Product into their own applications, customers must also refer to and comply with (a) the latest versions of all relevant TOSHIBA information, including without limitation, this document, the specifications, the data sheets and application notes for Product and the precautions and conditions set forth in the "TOSHIBA Semiconductor Reliability Handbook" and (b) the instructions for the application with which the Product will be used with or for. Customers are solely responsible for all aspects of their own product design or applications, including but not limited to (a) determining the appropriateness of the use of this Product in such design or applications; (b) evaluating and determining the applicability of any information contained in this document, or in charts, diagrams, programs, algorithms, sample application circuits, or any other referenced documents; and (c) validating all operating parameters for such designs and applications. **TOSHIBA ASSUMES NO LIABILITY FOR CUSTOMERS' PRODUCT DESIGN OR APPLICATIONS.**
- **PRODUCT IS NEITHER INTENDED NOR WARRANTED FOR USE IN EQUIPMENTS OR SYSTEMS THAT REQUIRE EXTRAORDINARILY HIGH LEVELS OF QUALITY AND/OR RELIABILITY, AND/OR A MALFUNCTION OR FAILURE OF WHICH MAY CAUSE LOSS OF HUMAN LIFE, BODILY INJURY, SERIOUS PROPERTY DAMAGE AND/OR SERIOUS PUBLIC IMPACT ("UNINTENDED USE").** Except for specific applications as expressly stated in this document, Unintended Use includes, without limitation, equipment used in nuclear facilities, equipment used in the aerospace industry, medical equipment, equipment used for automobiles, trains, ships and other transportation, traffic signaling equipment, equipment used to control combustions or explosions, safety devices, elevators and escalators, devices related to electric power, and equipment used in finance-related fields. **IF YOU USE PRODUCT FOR UNINTENDED USE, TOSHIBA ASSUMES NO LIABILITY FOR PRODUCT.** For details, please contact your TOSHIBA sales representative.
- Do not disassemble, analyze, reverse-engineer, alter, modify, translate or copy Product, whether in whole or in part.
- Product shall not be used for or incorporated into any products or systems whose manufacture, use, or sale is prohibited under any applicable laws or regulations.
- The information contained herein is presented only as guidance for Product use. No responsibility is assumed by TOSHIBA for any infringement of patents or any other intellectual property rights of third parties that may result from the use of Product. No license to any intellectual property right is granted by this document, whether express or implied, by estoppel or otherwise.
- **ABSENT A WRITTEN SIGNED AGREEMENT, EXCEPT AS PROVIDED IN THE RELEVANT TERMS AND CONDITIONS OF SALE FOR PRODUCT, AND TO THE MAXIMUM EXTENT ALLOWABLE BY LAW, TOSHIBA (1) ASSUMES NO LIABILITY WHATSOEVER, INCLUDING WITHOUT LIMITATION, INDIRECT, CONSEQUENTIAL, SPECIAL, OR INCIDENTAL DAMAGES OR LOSS, INCLUDING WITHOUT LIMITATION, LOSS OF PROFITS, LOSS OF OPPORTUNITIES, BUSINESS INTERRUPTION AND LOSS OF DATA, AND (2) DISCLAIMS ANY AND ALL EXPRESS OR IMPLIED WARRANTIES AND CONDITIONS RELATED TO SALE, USE OF PRODUCT, OR INFORMATION, INCLUDING WARRANTIES OR CONDITIONS OF MERCHANTABILITY, FITNESS FOR A PARTICULAR PURPOSE, ACCURACY OF INFORMATION, OR NONINFRINGEMENT.**
- GaAs (Gallium Arsenide) is used in Product. GaAs is harmful to humans if consumed or absorbed, whether in the form of dust or vapor. Handle with care and do not break, cut, crush, grind, dissolve chemically or otherwise expose GaAs in Product.
- Do not use or otherwise make available Product or related software or technology for any military purposes, including without limitation, for the design, development, use, stockpiling or manufacturing of nuclear, chemical, or biological weapons or missile technology products (mass destruction weapons). Product and related software and technology may be controlled under the applicable export laws and regulations including, without limitation, the Japanese Foreign Exchange and Foreign Trade Law and the U.S. Export Administration Regulations. Export and re-export of Product or related software or technology are strictly prohibited except in compliance with all applicable export laws and regulations.
- Please contact your TOSHIBA sales representative for details as to environmental matters such as the RoHS compatibility of Product. Please use Product in compliance with all applicable laws and regulations that regulate the inclusion or use of controlled substances, including without limitation, the EU RoHS Directive. **TOSHIBA ASSUMES NO LIABILITY FOR DAMAGES OR LOSSES OCCURRING AS A RESULT OF NONCOMPLIANCE WITH APPLICABLE LAWS AND REGULATIONS.**