



# U74LVC2G34

**CMOS IC**

## DUAL BUFFER GATE

### DESCRIPTION

The **U74LVC2G34** is a dual buffer, it provides the function  $Y = A$ .  
 This device has power-down protective circuit, preventing device destruction when it is powered down.

### FEATURES

- \* Operate From 1.65V to 5.5V
- \* Inputs Accept Voltages to 5.5V
- \* I<sub>OFF</sub> Supports Partial-Power-Down Mode
- \* Low Power Dissipation
- \* Max t<sub>PD</sub> of 4.1 ns at 3.3V

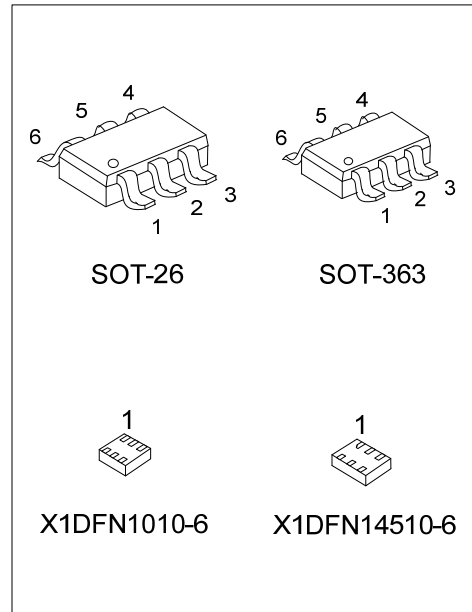

### ORDERING INFORMATION

Ordering Number		Package	Packing
Lead Free	Halogen Free		
U74LVC2G34L-AG6-R	U74LVC2G34G-AG6-R	SOT-26	Tape Reel
U74LVC2G34L-AL6-R	U74LVC2G34G-AL6-R	SOT-363	Tape Reel
U74LVC2G34L-K06-1010X1-R	U74LVC2G34G-K06-1010X1-R	X1DFN1010-6	Tape Reel
U74LVC2G34L-KAP-R	U74LVC2G34G-KAP-R	X1DFN14510-6	Tape Reel

<p>U74LVC2G34G-AG6-R</p> <p>(1) Packing Type          (2) Package Type          (3) Green Package</p>	<p>(1) R: Tape Reel          (2) AG6: SOT-26, AL6: SOT-363,          K06-1010X1: X1DFN1010-6, KAP: X1DFN14510-6          (3) G: Halogen Free and Lead Free, L: Lead Free</p>
---	--

### MARKING

SOT-26 / SOT-363	X1DFN1010-6	X1DFN14510-6
<p>L: Lead Free          G: Halogen Free</p>		<p>L: Lead Free          G: Halogen Free</p>

■ PIN CONFIGURATION

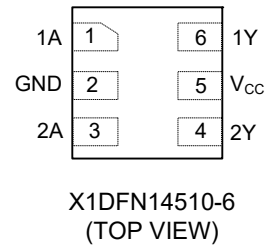
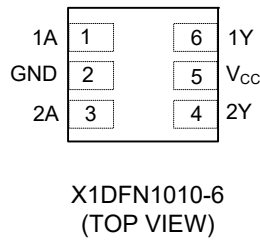
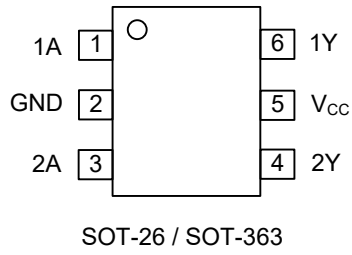

■ FUNCTION TABLE

INPUT(nA)	OUTPUT(nY)
H	H
L	L

Note: H: HIGH voltage level; L: LOW voltage level.

■ LOGIC DIAGRAM (Positive Logic)

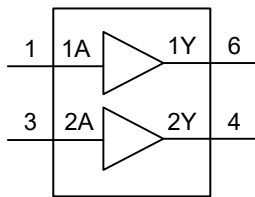

Logic Symbol

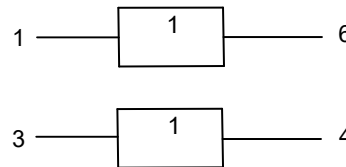

IEC Logic Symbol

## ■ ABSOLUTE MAXIMUM RATING

PARAMETER		SYMBOL	RATINGS	UNIT
Supply Voltage		$V_{CC}$	-0.5 ~ +6.5	V
Input Voltage		$V_{IN}$	-0.5 ~ +6.5	V
Output Voltage	Active mode	$V_{OUT}$	-0.5 ~ $V_{CC}+0.5$	V
	Power-down mode		-0.5 ~ +6.5	V
$V_{CC}$ or GND Current		$I_{CC}$	±100	mA
Continuous Output Current ( $V_{OUT}=0$ to $V_{CC}$ )		$I_{OUT}$	±50	mA
Input Clamp Current ( $V_{IN}<0$ )		$I_{IK}$	-50	mA
Output Clamp Current ( $V_{OUT}<0$ or $V_{OUT}>V_{CC}$ )		$I_{OK}$	-50	mA
Power Dissipation ( $T_A=-40^{\circ}C$ to $+125^{\circ}C$ )	SOT-26	$P_D$	360	mW
	SOT-363		300	mW
	X1DFN1010-6		200	mW
	X1DFN14510-6			mW
Storage Temperature Range		$T_{STG}$	-65 ~ +150	$^{\circ}C$

Note: Absolute maximum ratings are those values beyond which the device could be permanently damaged. Absolute maximum ratings are stress ratings only and functional device operation is not implied.

## ■ RECOMMENDED OPERATING CONDITIONS

PARAMETER	SYMBOL	TEST CONDITIONS	MIN	TYP	MAX	UNIT
Supply Voltage	$V_{CC}$	Operating	1.65		5.5	V
Input Voltage	$V_{IN}$		0		5.5	V
Output Voltage	$V_{OUT}$	Active mode	0		$V_{CC}$	V
		$V_{CC}=0V$ , Power-down mode	0		5.5	V
Input Rise or Fall Times	$t_R / t_F$	$V_{CC}=1.65V \sim 2.7V$	0		20	ns/V
		$V_{CC}=2.7V \sim 5.5V$	0		10	ns/V
Operating Temperature	$T_A$		-40		+125	$^{\circ}C$

## ■ ELECTRICAL CHARACTERISTICS ( $T_A=25^{\circ}C$ , unless otherwise specified)

PARAMETER	SYMBOL	TEST CONDITIONS	MIN	TYP	MAX	UNIT
High-Level Input Voltage	$V_{IH}$	$V_{CC}=1.65V \sim 1.95V$	$0.65 \times V_{CC}$			V
		$V_{CC}=2.3V \sim 2.7V$	1.7			V
		$V_{CC}=3V \sim 3.6V$	2			V
		$V_{CC}=4.5V \sim 5.5V$	$0.7 \times V_{CC}$			V
Low-Level Input Voltage	$V_{IL}$	$V_{CC}=1.65V \sim 1.95V$			$0.35 \times V_{CC}$	V
		$V_{CC}=2.3V \sim 2.7V$			0.7	V
		$V_{CC}=3V \sim 3.6V$			0.8	V
		$V_{CC}=4.5V \sim 5.5V$			$0.3 \times V_{CC}$	V
High-Level Output Voltage	$V_{OH}$	$V_{CC}=1.65 \sim 5.5V$ , $I_{OH}=-100\mu A$	$V_{CC}-0.1$			V
		$V_{CC}=1.65V$ , $I_{OH}=-4mA$	1.2			V
		$V_{CC}=2.3V$ , $I_{OH}=-8mA$	1.9			V
		$V_{CC}=2.7V$ , $I_{OH}=-12mA$	2.2			V
		$V_{CC}=3.0V$ , $I_{OH}=-24mA$	2.3			V
		$V_{CC}=4.5V$ , $I_{OH}=-32mA$	3.8			V
Low-Level Output Voltage	$V_{OL}$	$V_{CC}=1.65 \sim 5.5V$ , $I_{OL}=100\mu A$			0.1	V
		$V_{CC}=1.65V$ , $I_{OL}=4mA$			0.45	V
		$V_{CC}=2.3V$ , $I_{OL}=8mA$			0.3	V
		$V_{CC}=2.7V$ , $I_{OL}=12mA$			0.4	V
		$V_{CC}=3.0V$ , $I_{OL}=24mA$			0.55	V
		$V_{CC}=4.5V$ , $I_{OL}=32mA$			0.55	V

### ■ ELECTRICAL CHARACTERISTICS (Cont.)

PARAMETER	SYMBOL	TEST CONDITIONS	MIN	TYP	MAX	UNIT
Input Leakage Current	$I_{I(LEAK)}$	$V_{IN}=5.5V$ or GND, $V_{CC}=5.5V$			± 5	μA
Power OFF Leakage Current	$I_{OFF}$	$V_{IN}$ or $V_{OUT}=5.5V$ , $V_{CC}=0V$			±10	μA
Quiescent Supply Current	$I_Q$	$V_{IN}=5.5V$ or GND, $I_{OUT}=0$ $V_{CC}=5.5V$			10	μA
Additional Quiescent Supply Current Per Input Pin	$\Delta I_Q$	$V_{CC}=2.3 \sim 5.5V$ , $I_{OUT}=0$ One input at $V_{CC}-0.6V$ , Other inputs at $V_{CC}$ or GND			500	μA
Input Capacitance	$C_{IN}$			2.5		pF

### ■ SWITCHING CHARACTERISTICS ( $T_A=25^\circ C$ , unless otherwise specified)

PARAMETER	SYMBOL	TEST CONDITIONS	MIN	TYP	MAX	UNIT	
Propagation delay from input (nA) to output(nY)	$t_{PLH} / t_{PHL}$	$C_L=30pF$	$V_{CC}=1.65V \sim 1.95V$ , $R_L=1K\Omega$	1.0	3.8	8.6	ns
			$V_{CC}=2.3V \sim 2.7V$ , $R_L=500\Omega$	0.5	2.4	4.4	ns
		$C_L=50pF$	$V_{CC}=2.7V$ , $R_L=500\Omega$	0.5	2.5	5.0	ns
			$V_{CC}=3.0V \sim 3.6V$ , $R_L=500\Omega$	0.5	2.2	4.1	ns
			$V_{CC}=4.5V \sim 5.5V$ , $R_L=500\Omega$	0.5	1.9	3.2	ns

### ■ OPERATING CHARACTERISTICS ( $T_A=25^\circ C$ , unless otherwise specified)

PARAMETER	SYMBOL	TEST CONDITIONS	MIN	TYP	MAX	UNIT
Power Dissipation Capacitance	$C_{PD}$	$V_{CC}=3.3V$ , $V_{IN}=GND$ to $V_{CC}$		20		pF

■ TEST CIRCUIT AND WAVEFORMS

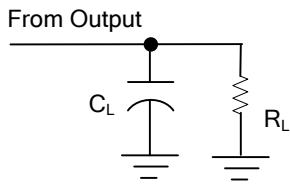

TEST CIRCUIT

V <sub>CC</sub>	INPUTS		V <sub>M</sub>	C <sub>L</sub>	R <sub>L</sub>
	V <sub>IN</sub>	t <sub>R</sub> , t <sub>F</sub>			
1.65V ~ 1.95V	V <sub>CC</sub>	≤2ns	V <sub>CC</sub> /2	30pF	1KΩ
2.3V ~ 2.7V	V <sub>CC</sub>	≤2ns	V <sub>CC</sub> /2	30pF	500Ω
2.7V	2.7V	≤2.5ns	1.5V	50pF	500Ω
3.0V ~ 3.6V	2.7V	≤2.5ns	1.5V	50pF	500Ω
4.5V ~ 5.5V	V <sub>CC</sub>	≤2.5ns	V <sub>CC</sub> /2	50pF	500Ω

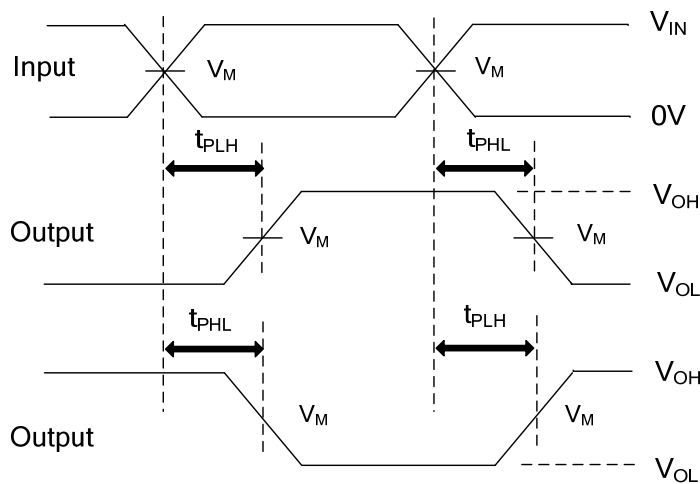

PROPAGATION DELAY TIMES

Note: C<sub>L</sub> includes probe and jig capacitance.

All input pulses are supplied by generators having the following characteristics: PRR ≤10MHz, Z<sub>o</sub> = 50Ω.

UTC assumes no responsibility for equipment failures that result from using products at values that exceed, even momentarily, rated values (such as maximum ratings, operating condition ranges, or other parameters) listed in products specifications of any and all UTC products described or contained herein. UTC products are not designed for use in life support appliances, devices or systems where malfunction of these products can be reasonably expected to result in personal injury. Reproduction in whole or in part is prohibited without the prior written consent of the copyright owner. UTC reserves the right to make changes to information published in this document, including without limitation specifications and product descriptions, at any time and without notice. This document supersedes and replaces all information supplied prior to the publication hereof.