

## TELUX™ LED

### Description

The TELUX™ series is a clear, non diffused LED for high end applications where supreme luminous flux is required.

It is designed in an industry standard 7.62 mm square package utilizing highly developed (AS) AlInGaP and InGaN technologies.

The supreme heat dissipation of TELUX™ allows applications at high ambient temperatures.

All packing units are binned for luminous flux and color to achieve best homogenous light appearance in application.

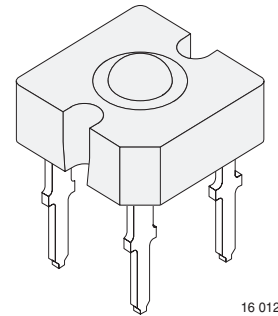

### Features

- Utilizing (AS) AlInGaP and InGaN technologies
- High luminous flux
- Supreme heat dissipation:  $R_{thJP}$  is 90 K/W
- High operating temperature:  $T_j$  up to + 125 °C
- Type TLWR meets SAE and ECE color requirements
- Packed in tubes for automatic insertion
- Luminous flux and color categorized for each tube
- Small mechanical tolerances allow precise usage of external reflectors or lightguides

- TLWR and TLWY types additionally forward voltage categorized
- ESD-withstand voltage:  
> 2 kV acc. to MIL STD 883 D, Method 3015.7 for AlInGaP, > 1 kV for InGaN

### Applications

- Exterior lighting
- Dashboard illumination
- Tail-, Stop - and Turn Signals of motor vehicles
- Replaces incandescent lamps
- Traffic signals and signs

### Parts Table

Part	Color, Luminous Intensity	Angle of Half Intensity ( $\pm\phi$ )	Technology
TLWR7600	Red, $\phi_V = (1500 \text{ to } 3000) \text{ mlm}$	30	AlInGaP on GaAs
TLWY7600	Yellow, $\phi_V = (1000 \text{ to } 2400) \text{ mlm}$	30	AlInGaP on GaAs
TLWO7600	Soft orange, $\phi_V = (1500 \text{ to } 3000) \text{ mlm}$	30	AlInGaP on GaAs
TLWTG7600	True green, $\phi_V = (630 \text{ to } 1800) \text{ mlm}$	30	InGaN on SiC
TLWBG7600	Blue green, $\phi_V = (400 \text{ to } 1250) \text{ mlm}$	30	InGaN on SiC
TLWB7600	Blue, $\phi_V = (200 \text{ to } 630) \text{ mlm}$	30	InGaN on SiC
TLWW7600	White, $\phi_V = (200 \text{ to } 630) \text{ mlm}$	30	InGaN / YAG on SiC

### Absolute Maximum Ratings

$T_{amb} = 25\text{ }^{\circ}\text{C}$ , unless otherwise specified

TLWR7600 , TLWY7600 , TLWO7600 ,

Parameter	Test condition	Symbol	Value	Unit
Reverse voltage	$I_R = 10\ \mu\text{A}$	$V_R$	10	V
DC forward current	$T_{amb} \leq 85\text{ }^{\circ}\text{C}$	$I_F$	70	mA
Surge forward current	$t_p \leq 10\ \mu\text{s}$	$I_{FSM}$	1	A
Power dissipation	$T_{amb} \leq 85\text{ }^{\circ}\text{C}$	$P_V$	187	mW
Junction temperature		$T_j$	125	$^{\circ}\text{C}$
Operating temperature range		$T_{amb}$	- 40 to + 110	$^{\circ}\text{C}$
Storage temperature range		$T_{stg}$	- 55 to + 110	$^{\circ}\text{C}$
Soldering temperature	$t \leq 5\ \text{s}$ , 1.5 mm from body preheat temperature 100 $^{\circ}\text{C}$ / 30 sec.	$T_{sd}$	260	$^{\circ}\text{C}$
Thermal resistance junction/ ambient	with cathode heatsink of 70 mm <sup>2</sup>	$R_{thJA}$	200	K/W
Thermal resistance junction/pin		$R_{thJP}$	90	K/W

TLWTG7600 , TLWBG7600 , TLWB7600 , TLWW7600

Parameter	Test condition	Symbol	Value	Unit
Reverse voltage	$I_R = 10\ \mu\text{A}$	$V_R$	5	V
DC forward current	$T_{amb} \leq 50\text{ }^{\circ}\text{C}$	$I_F$	50	mA
Surge forward current	$t_p \leq 10\ \mu\text{s}$	$I_{FSM}$	0.1	A
Power dissipation	$T_{amb} \leq 50\text{ }^{\circ}\text{C}$	$P_V$	230	mW
	$T_{amb} \leq 50\text{ }^{\circ}\text{C}$	$P_V$	230	mW
	$T_{amb} \leq 50\text{ }^{\circ}\text{C}$	$P_V$	230	mW
	$T_{amb} \leq 50\text{ }^{\circ}\text{C}$	$P_V$	255	mW
Junction temperature		$T_j$	100	$^{\circ}\text{C}$
Operating temperature range		$T_{amb}$	- 40 to + 100	$^{\circ}\text{C}$
Storage temperature range		$T_{stg}$	- 55 to + 100	$^{\circ}\text{C}$
Soldering temperature	$t \leq 5\ \text{s}$ , 1.5 mm from body preheat temperature 100 $^{\circ}\text{C}$ / 30 sec.	$T_{sd}$	260	$^{\circ}\text{C}$
Thermal resistance junction/ ambient	with cathode heatsink of 70 mm <sup>2</sup>	$R_{thJA}$	200	K/W
Thermal resistance junction/pin		$R_{thJP}$	90	K/W

### Optical and Electrical Characteristics

$T_{amb} = 25\text{ }^{\circ}\text{C}$ , unless otherwise specified

#### Red

TLWR7600

Parameter	Test condition	Symbol	Min	Typ.	Max	Unit
Total flux	$I_F = 70\ \text{mA}$ , $R_{thJA} = 200\text{ }^{\circ}\text{K/W}$	$\phi_V$	1500	2100	3000	mlm
Luminous intensity/Total flux	$I_F = 70\ \text{mA}$ , $R_{thJA} = 200\text{ }^{\circ}\text{K/W}$	$I_V/\phi_V$		0.8		mcd/mlm
Dominant wavelength	$I_F = 70\ \text{mA}$ , $R_{thJA} = 200\text{ }^{\circ}\text{K/W}$	$\lambda_d$	611	618	634	nm
Peak wavelength	$I_F = 70\ \text{mA}$ , $R_{thJA} = 200\text{ }^{\circ}\text{K/W}$	$\lambda_p$		624		nm
Angle of half intensity	$I_F = 70\ \text{mA}$ , $R_{thJA} = 200\text{ }^{\circ}\text{K/W}$	$\phi$		$\pm 30$		deg
Total included angle	90 % of Total Flux Captured	$\phi$		75		deg
Forward voltage	$I_F = 70\ \text{mA}$ , $R_{thJA} = 200\text{ }^{\circ}\text{K/W}$	$V_F$	1.83	2.2	2.67	V



Parameter	Test condition	Symbol	Min	Typ.	Max	Unit
Reverse voltage	$I_R = 10 \mu\text{A}$	$V_R$	10	20		V
Junction capacitance	$V_R = 0, f = 1 \text{ MHz}$	$C_j$		17		pF
Temperature coefficient of $\lambda_{\text{dom}}$	$I_F = 50 \text{ mA}$	$TC_{\lambda_{\text{dom}}}$		0.05		nm/K

## Soft Orange

### TLWO7600

Parameter	Test condition	Symbol	Min	Typ.	Max	Unit
Total flux	$I_F = 70 \text{ mA}, R_{\text{thJA}} = 200 \text{ }^\circ\text{K/W}$	$\phi_V$	1500	2100	3000	mlm
Luminous intensity/Total flux	$I_F = 70 \text{ mA}, R_{\text{thJA}} = 200 \text{ }^\circ\text{K/W}$	$I_V/\phi_V$		0.8		mcd/mlm
Dominant wavelength	$I_F = 70 \text{ mA}, R_{\text{thJA}} = 200 \text{ }^\circ\text{K/W}$	$\lambda_d$	598	605	611	nm
Peak wavelength	$I_F = 70 \text{ mA}, R_{\text{thJA}} = 200 \text{ }^\circ\text{K/W}$	$\lambda_p$		610		nm
Angle of half intensity	$I_F = 70 \text{ mA}, R_{\text{thJA}} = 200 \text{ }^\circ\text{K/W}$	$\phi$		$\pm 30$		deg
Total included angle	90 % of Total Flux Captured	$\phi$		75		deg
Forward voltage	$I_F = 70 \text{ mA}, R_{\text{thJA}} = 200 \text{ }^\circ\text{K/W}$	$V_F$	1.83	2.2	2.67	V
Reverse voltage	$I_R = 10 \mu\text{A}$	$V_R$	10	20		V
Junction capacitance	$V_R = 0, f = 1 \text{ MHz}$	$C_j$		17		pF
Temperature coefficient of $\lambda_{\text{dom}}$	$I_F = 50 \text{ mA}$	$TC_{\lambda_{\text{dom}}}$		0.06		nm/K

## Yellow

### TLWY7600

Parameter	Test condition	Symbol	Min	Typ.	Max	Unit
Total flux	$I_F = 70 \text{ mA}, R_{\text{thJA}} = 200 \text{ }^\circ\text{K/W}$	$\phi_V$	1000	1400	2400	mlm
Luminous intensity/Total flux	$I_F = 70 \text{ mA}, R_{\text{thJA}} = 200 \text{ }^\circ\text{K/W}$	$I_V/\phi_V$		0.8		mcd/mlm
Dominant wavelength	$I_F = 70 \text{ mA}, R_{\text{thJA}} = 200 \text{ }^\circ\text{K/W}$	$\lambda_d$	585	592	597	nm
Peak wavelength	$I_F = 70 \text{ mA}, R_{\text{thJA}} = 200 \text{ }^\circ\text{K/W}$	$\lambda_p$		594		nm
Angle of half intensity	$I_F = 70 \text{ mA}, R_{\text{thJA}} = 200 \text{ }^\circ\text{K/W}$	$\phi$		$\pm 30$		deg
Total included angle	90 % of Total Flux Captured	$\phi$		75		deg
Forward voltage	$I_F = 70 \text{ mA}, R_{\text{thJA}} = 200 \text{ }^\circ\text{K/W}$	$V_F$	1.83	2.1	2.67	V
Reverse voltage	$I_R = 10 \mu\text{A}$	$V_R$	10	15		V
Junction capacitance	$V_R = 0, f = 1 \text{ MHz}$	$C_j$		32		pF
Temperature coefficient of $\lambda_{\text{dom}}$	$I_F = 50 \text{ mA}$	$TC_{\lambda_{\text{dom}}}$		0.1		nm/K

## True green

### TLWTG7600

Parameter	Test condition	Symbol	Min	Typ.	Max	Unit
Total flux	$I_F = 50 \text{ mA}, R_{\text{thJA}} = 200 \text{ }^\circ\text{K/W}$	$\phi_V$	630	900	1800	mlm
Luminous intensity/Total flux	$I_F = 50 \text{ mA}, R_{\text{thJA}} = 200 \text{ }^\circ\text{K/W}$	$I_V/\phi_V$		0.8		mcd/mlm
Dominant wavelength	$I_F = 50 \text{ mA}, R_{\text{thJA}} = 200 \text{ }^\circ\text{K/W}$	$\lambda_d$	509	523	529	nm
Peak wavelength	$I_F = 50 \text{ mA}, R_{\text{thJA}} = 200 \text{ }^\circ\text{K/W}$	$\lambda_p$		518		nm
Angle of half intensity	$I_F = 50 \text{ mA}, R_{\text{thJA}} = 200 \text{ }^\circ\text{K/W}$	$\phi$		$\pm 30$		deg
Total included angle	90 % of Total Flux Captured	$\phi$		75		deg
Forward voltage	$I_F = 50 \text{ mA}, R_{\text{thJA}} = 200 \text{ }^\circ\text{K/W}$	$V_F$		4.2	4.7	V
Reverse voltage	$I_R = 10 \mu\text{A}$	$V_R$	5	10		V
Junction capacitance	$V_R = 0, f = 1 \text{ MHz}$	$C_j$		50		pF
Temperature coefficient of $\lambda_{\text{dom}}$	$I_F = 30 \text{ mA}$	$TC_{\lambda_{\text{dom}}}$		0.02		nm/K

### Optical and Electrical Characteristics

$T_{amb} = 25\text{ }^{\circ}\text{C}$ , unless otherwise specified

#### Blue green

##### TLWBG7600

Parameter	Test condition	Symbol	Min	Typ.	Max	Unit
Total flux	$I_F = 50\text{ mA}$ , $R_{thJA} = 200\text{ }^{\circ}\text{K/W}$	$\phi_V$	400	700	1250	mlm
Luminous intensity/Total flux	$I_F = 50\text{ mA}$ , $R_{thJA} = 200\text{ }^{\circ}\text{K/W}$	$I_V/\phi_V$		0.8		mcd/mlm
Dominant wavelength	$I_F = 50\text{ mA}$ , $R_{thJA} = 200\text{ }^{\circ}\text{K/W}$	$\lambda_d$	492	505	510	nm
Peak wavelength	$I_F = 50\text{ mA}$ , $R_{thJA} = 200\text{ }^{\circ}\text{K/W}$	$\lambda_p$		503		nm
Angle of half intensity	$I_F = 50\text{ mA}$ , $R_{thJA} = 200\text{ }^{\circ}\text{K/W}$	$\phi$		$\pm 30$		deg
Total included angle	90 % of Total Flux Captured	$\phi$		75		deg
Forward voltage	$I_F = 50\text{ mA}$ , $R_{thJA} = 200\text{ }^{\circ}\text{K/W}$	$V_F$		4.2	4.7	V
Reverse voltage	$I_R = 10\text{ }\mu\text{A}$	$V_R$	5	10		V
Junction capacitance	$V_R = 0$ , $f = 1\text{ MHz}$	$C_j$		50		pF
Temperature coefficient of $\lambda_{dom}$	$I_F = 30\text{ mA}$	$TC_{\lambda_{dom}}$		0.02		nm/K

#### Blue

##### TLWB7600

Parameter	Test condition	Symbol	Min	Typ.	Max	Unit
Total flux	$I_F = 50\text{ mA}$ , $R_{thJA} = 200\text{ }^{\circ}\text{K/W}$	$\phi_V$	200	330	630	mlm
Luminous intensity/Total flux	$I_F = 50\text{ mA}$ , $R_{thJA} = 200\text{ }^{\circ}\text{K/W}$	$I_V/\phi_V$		0.8		mcd/mlm
Dominant wavelength	$I_F = 50\text{ mA}$ , $R_{thJA} = 200\text{ }^{\circ}\text{K/W}$	$\lambda_d$	462	470	476	nm
Peak wavelength	$I_F = 50\text{ mA}$ , $R_{thJA} = 200\text{ }^{\circ}\text{K/W}$	$\lambda_p$		460		nm
Angle of half intensity	$I_F = 50\text{ mA}$ , $R_{thJA} = 200\text{ }^{\circ}\text{K/W}$	$\phi$		$\pm 30$		deg
Total included angle	90 % of Total Flux Captured	$\phi$		75		deg
Forward voltage	$I_F = 50\text{ mA}$ , $R_{thJA} = 200\text{ }^{\circ}\text{K/W}$	$V_F$		4.3	4.7	V
Reverse voltage	$I_R = 10\text{ }\mu\text{A}$	$V_R$	5	10		V
Junction capacitance	$V_R = 0$ , $f = 1\text{ MHz}$	$C_j$		50		pF
Temperature coefficient of $\lambda_{dom}$	$I_F = 30\text{ mA}$	$TC_{\lambda_{dom}}$		0.03		nm/K

#### White

##### TLWW7600

Parameter	Test condition	Symbol	Min	Typ.	Max	Unit
Total flux	$I_F = 50\text{ mA}$ , $R_{thJA} = 200\text{ }^{\circ}\text{K/W}$	$\phi_V$	400	650	1250	mlm
Luminous intensity/Total flux	$I_F = 50\text{ mA}$ , $R_{thJA} = 200\text{ }^{\circ}\text{K/W}$	$I_V/\phi_V$		0.8		mcd/mlm
Color temperature	$I_F = 50\text{ mA}$ , $R_{thJA} = 200\text{ }^{\circ}\text{K/W}$	$T_K$		5500		K
Angle of half intensity	$I_F = 50\text{ mA}$ , $R_{thJA} = 200\text{ }^{\circ}\text{K/W}$	$\phi$		$\pm 30$		deg
Total included angle	90 % of Total Flux Captured	$\phi$		75		deg
Forward voltage	$I_F = 50\text{ mA}$ , $R_{thJA} = 200\text{ }^{\circ}\text{K/W}$	$V_F$		4.3	5.1	V
Reverse voltage	$I_R = 10\text{ }\mu\text{A}$	$V_R$	5	10		V
Junction capacitance	$V_R = 0$ , $f = 1\text{ MHz}$	$C_j$		50		pF

### Typical Characteristics ( $T_{amb} = 25\text{ }^{\circ}\text{C}$ unless otherwise specified)

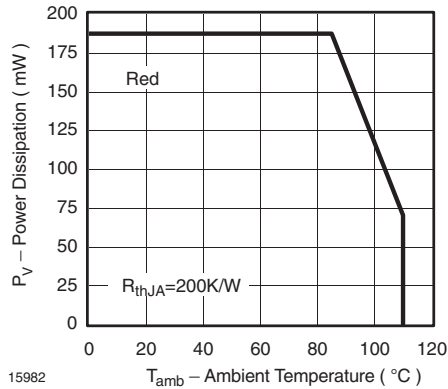

Figure 1. Power Dissipation vs. Ambient Temperature

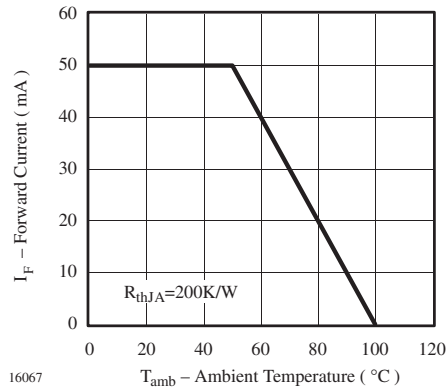

Figure 4. Forward Current vs. Ambient Temperature for InGaN

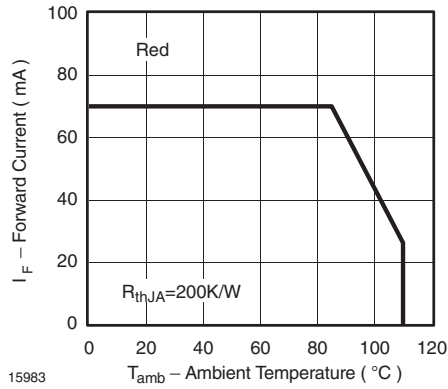

Figure 2. Forward Current vs. Ambient Temperature

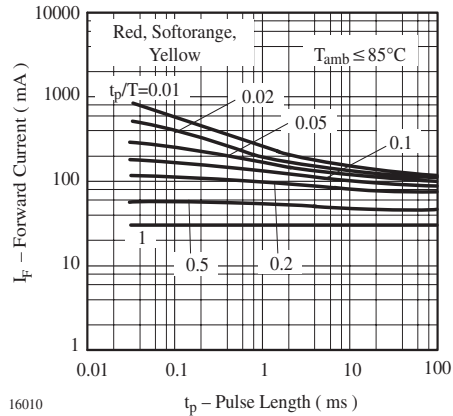

Figure 5. Forward Current vs. Pulse Length

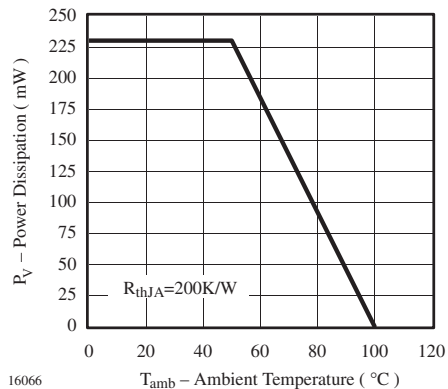

Figure 3. Power Dissipation vs. Ambient Temperature

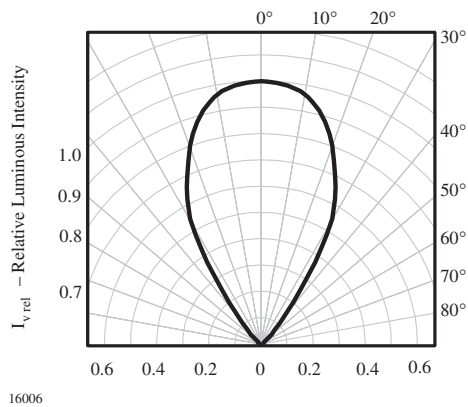

Figure 6. Rel. Luminous Intensity vs. Angular Displacement for 60° emission angle

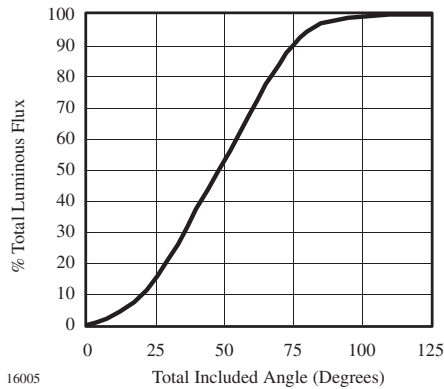

Figure 7. Percentage Total Luminous Flux vs. Total Included Angle for 60° emission angle

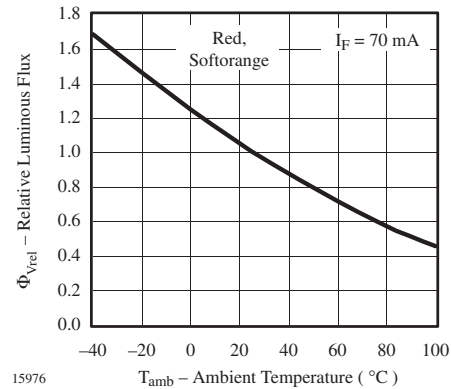

Figure 10. Rel. Luminous Flux vs. Ambient Temperature

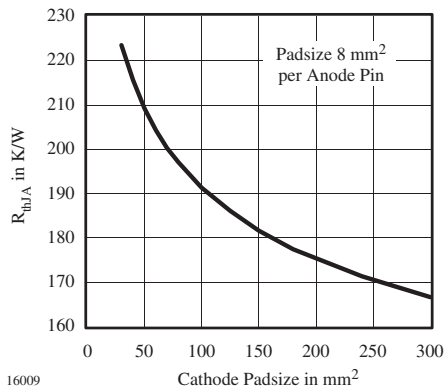

Figure 8. Thermal Resistance Junction Ambient vs. Cathode Padsizes

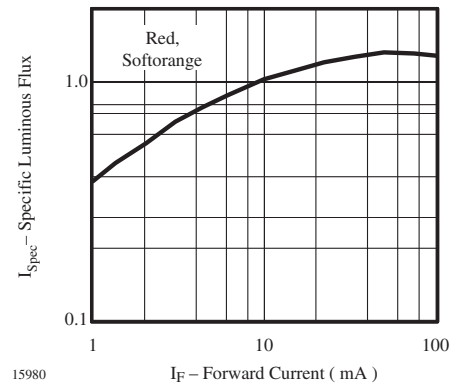

Figure 11. Specific Luminous Flux vs. Forward Current

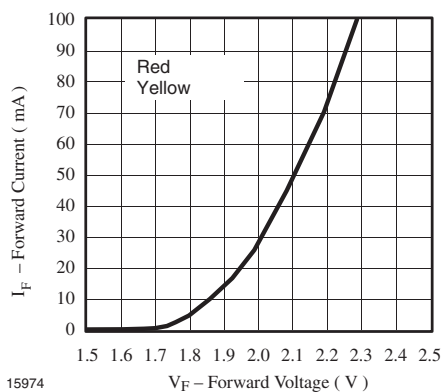

Figure 9. Forward Current vs. Forward Voltage

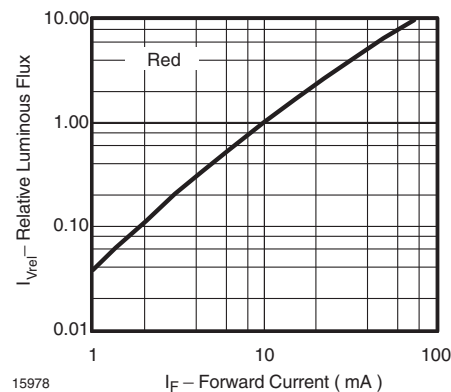
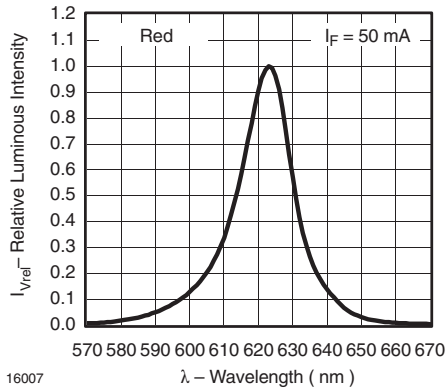
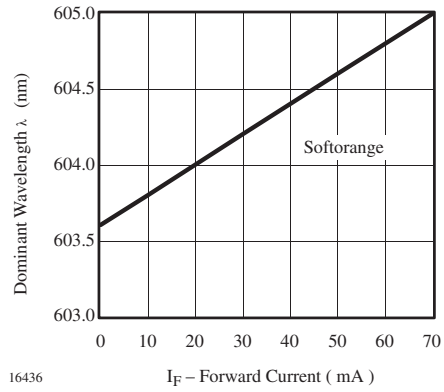

Figure 12. Relative Luminous Flux vs. Forward Current



16007

Figure 13. Relative Intensity vs. Wavelength



16436

Figure 16. Dominant Wavelength vs. Forward Current

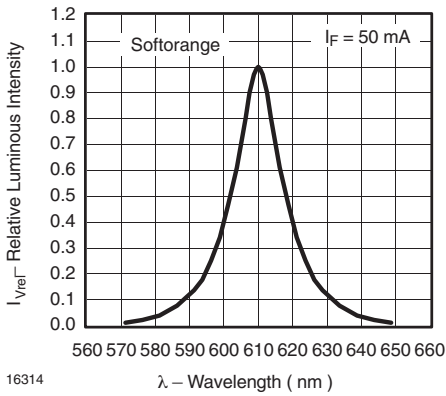

16314

Figure 14. Relative Intensity vs. Wavelength

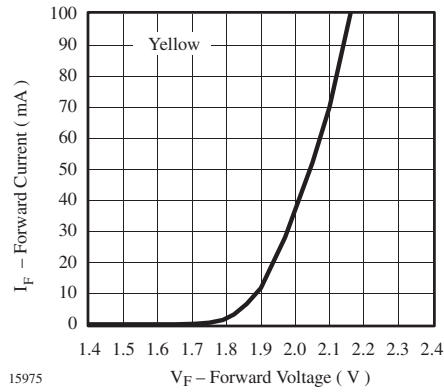

15975

Figure 17. Forward Current vs. Forward Voltage

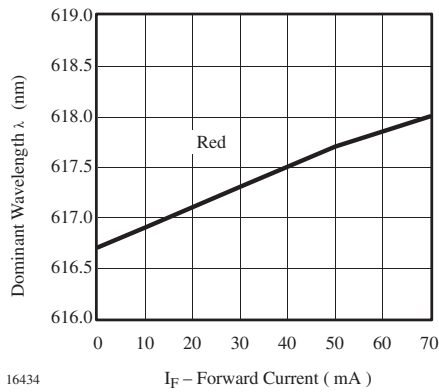

16434

Figure 15. Dominant Wavelength vs. Forward Current

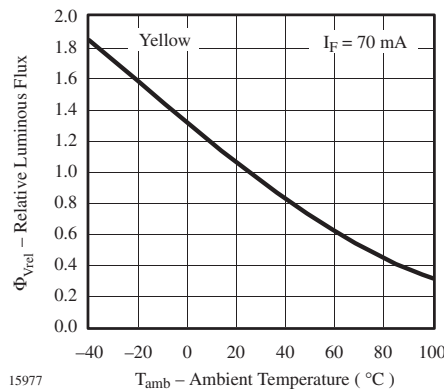

15977

Figure 18. Rel. Luminous Flux vs. Ambient Temperature

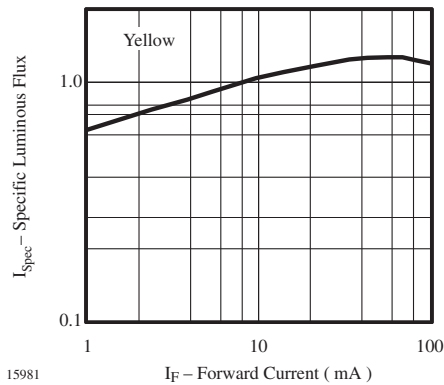

15981

Figure 19. Specific Luminous Flux vs. Forward Current

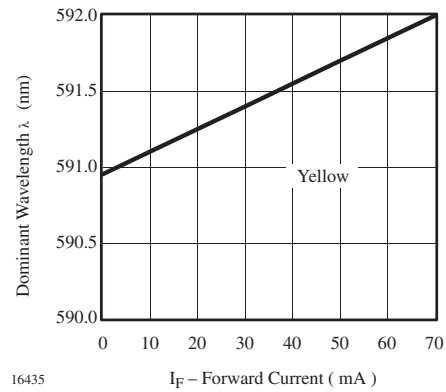

16435

Figure 22. Dominant Wavelength vs. Forward Current

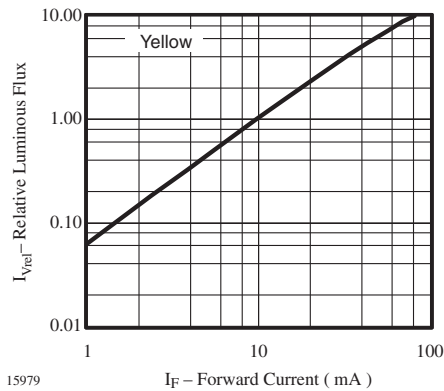

15979

Figure 20. Relative Luminous Flux vs. Forward Current

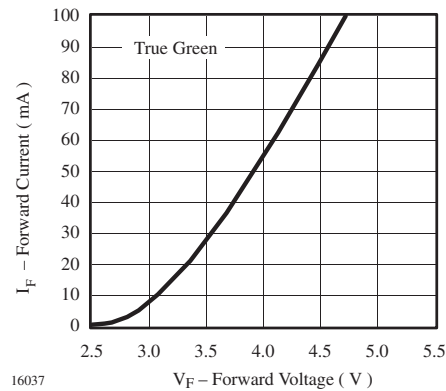

16037

Figure 23. Forward Current vs. Forward Voltage

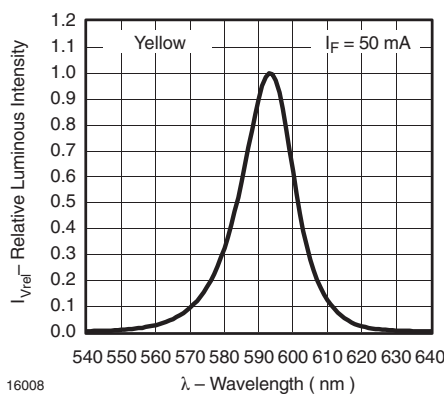

16008

Figure 21. Relative Intensity vs. Wavelength

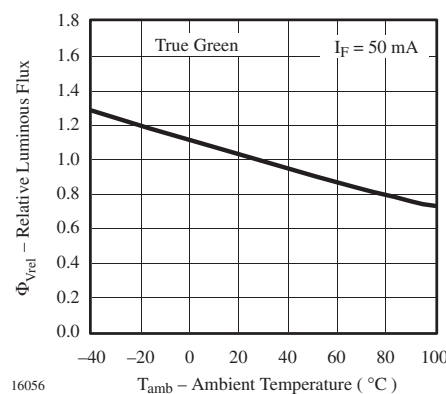

16056

Figure 24. Rel. Luminous Flux vs. Ambient Temperature



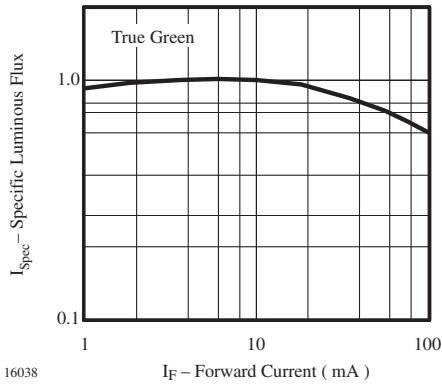

Figure 25. Specific Luminous Flux vs. Forward Current

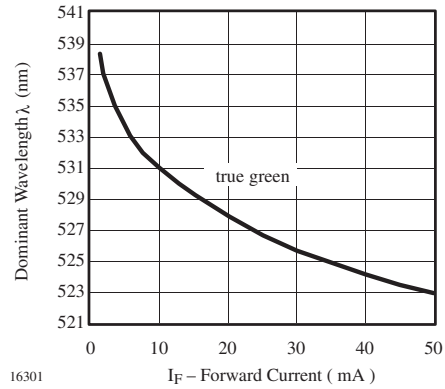

Figure 28. Dominant Wavelength vs. Forward Current

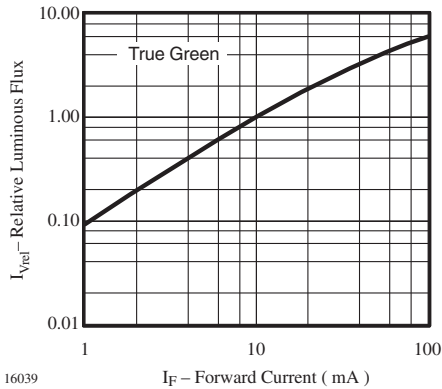

Figure 26. Relative Luminous Flux vs. Forward Current

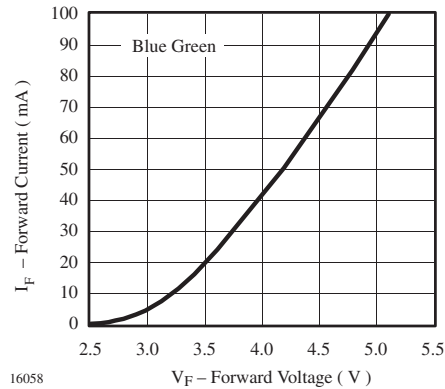

Figure 29. Forward Current vs. Forward Voltage

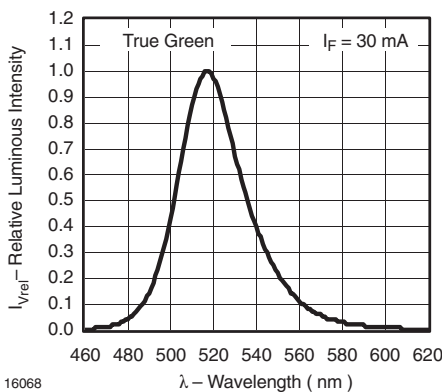

Figure 27. Relative Intensity vs. Wavelength

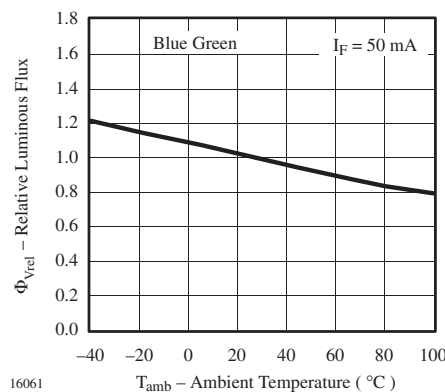
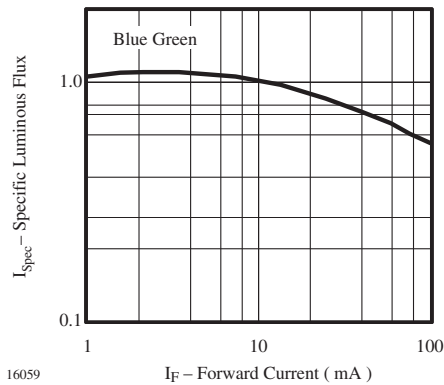
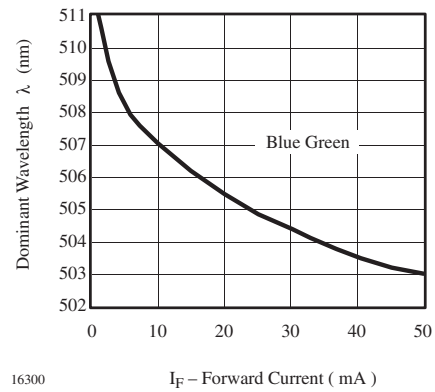

Figure 30. Rel. Luminous Flux vs. Ambient Temperature



16059

Figure 31. Specific Luminous Flux vs. Forward Current



16300

Figure 34. Dominant Wavelength vs. Forward Current

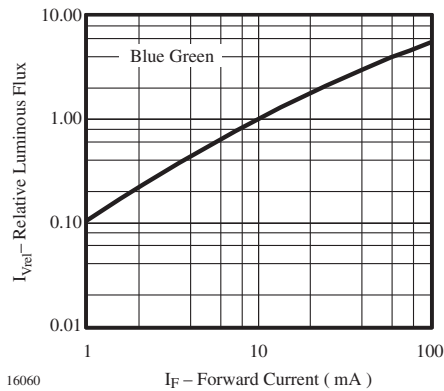

16060

Figure 32. Relative Luminous Flux vs. Forward Current

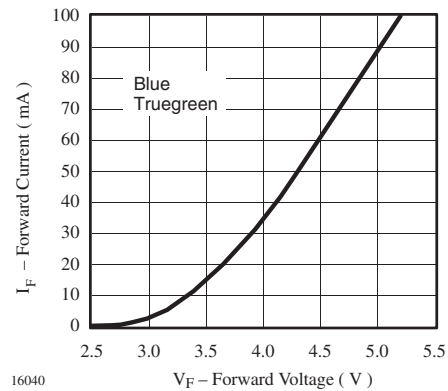

16040

Figure 35. Forward Current vs. Forward Voltage

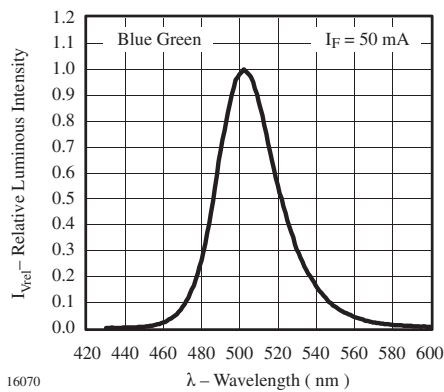

16070

Figure 33. Relative Intensity vs. Wavelength

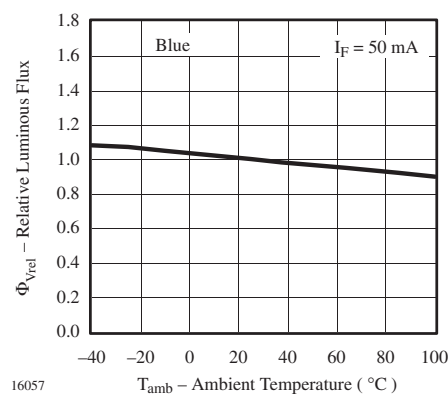

16057

Figure 36. Rel. Luminous Flux vs. Ambient Temperature

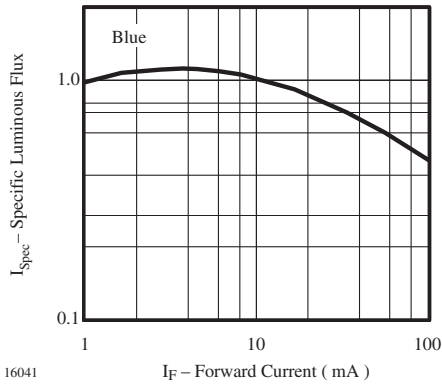

Figure 37. Specific Luminous Flux vs. Forward Current

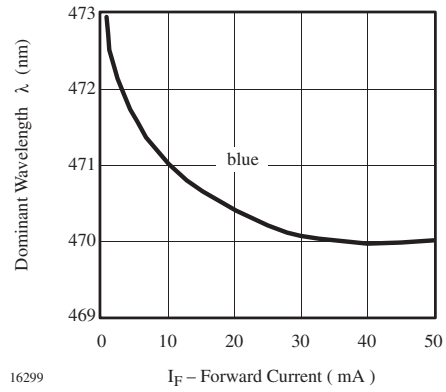

Figure 40. Dominant Wavelength vs. Forward Current

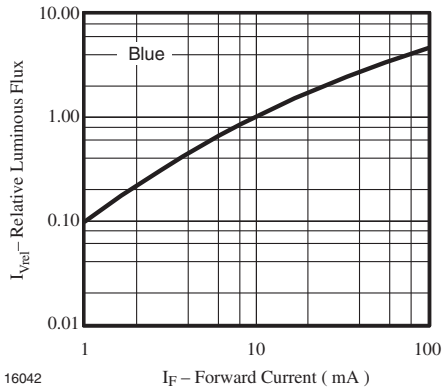

Figure 38. Relative Luminous Flux vs. Forward Current

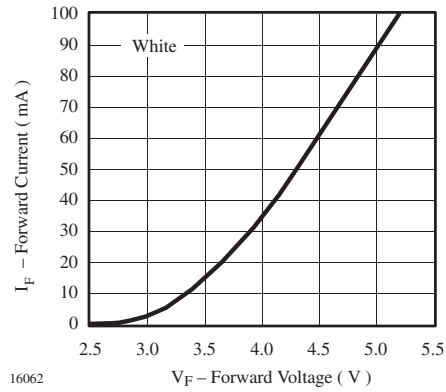

Figure 41. Forward Current vs. Forward Voltage

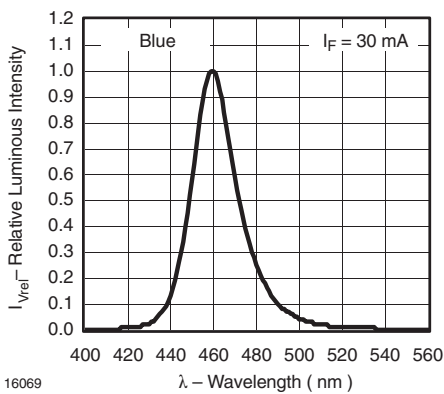

Figure 39. Relative Intensity vs. Wavelength

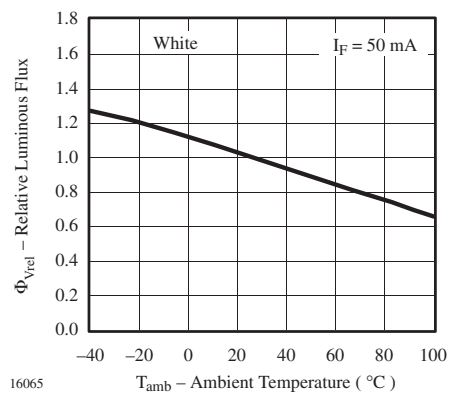
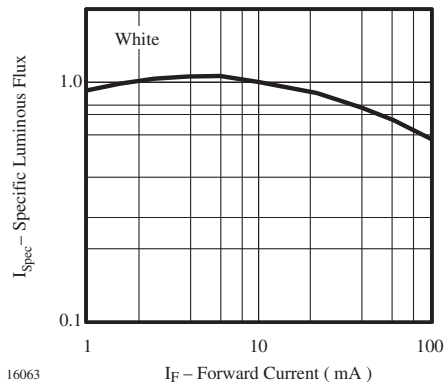
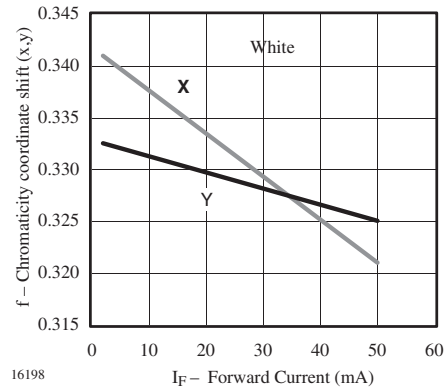

Figure 42. Rel. Luminous Flux vs. Ambient Temperature



16063

Figure 43. Specific Luminous Flux vs. Forward Current



16198

Figure 46. Chromaticity Coordinate Shift vs. Forward Current

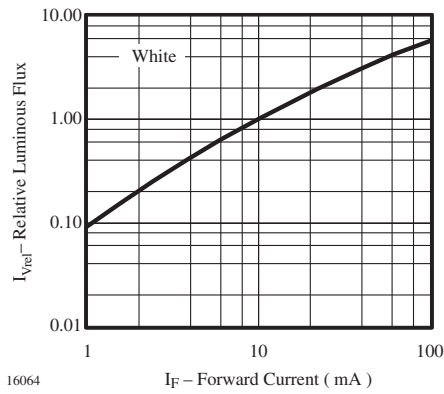

16064

Figure 44. Relative Luminous Flux vs. Forward Current

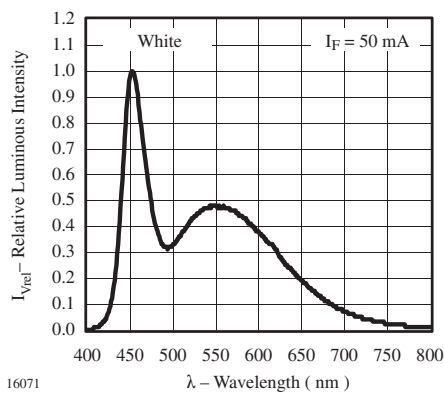

16071

Figure 45. Relative Intensity vs. Wavelength

## Package Dimensions in mm

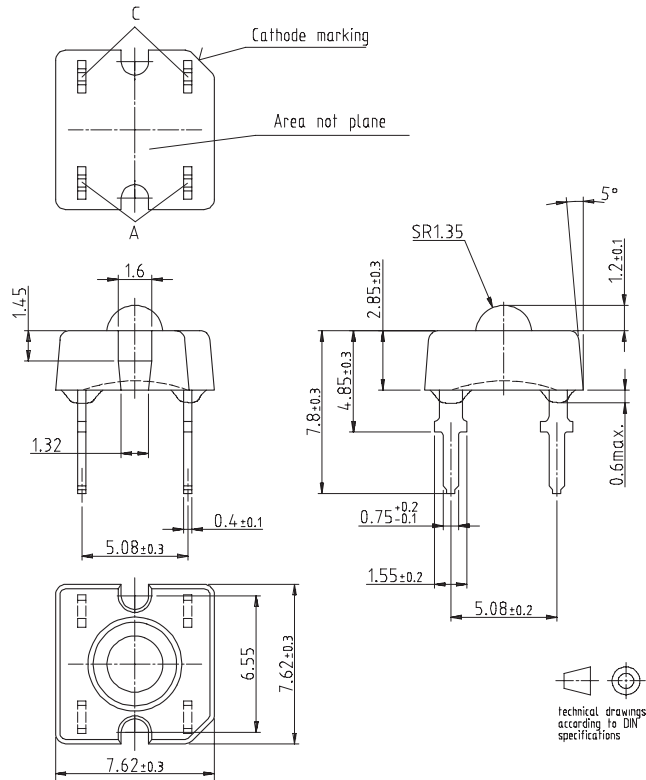

16004

### Ozone Depleting Substances Policy Statement

It is the policy of **Vishay Semiconductor GmbH** to

1. Meet all present and future national and international statutory requirements.
2. Regularly and continuously improve the performance of our products, processes, distribution and operating systems with respect to their impact on the health and safety of our employees and the public, as well as their impact on the environment.

It is particular concern to control or eliminate releases of those substances into the atmosphere which are known as ozone depleting substances (ODSs).

The Montreal Protocol (1987) and its London Amendments (1990) intend to severely restrict the use of ODSs and forbid their use within the next ten years. Various national and international initiatives are pressing for an earlier ban on these substances.

**Vishay Semiconductor GmbH** has been able to use its policy of continuous improvements to eliminate the use of ODSs listed in the following documents.

1. Annex A, B and list of transitional substances of the Montreal Protocol and the London Amendments respectively
2. Class I and II ozone depleting substances in the Clean Air Act Amendments of 1990 by the Environmental Protection Agency (EPA) in the USA
3. Council Decision 88/540/EEC and 91/690/EEC Annex A, B and C (transitional substances) respectively.

**Vishay Semiconductor GmbH** can certify that our semiconductors are not manufactured with ozone depleting substances and do not contain such substances.

**We reserve the right to make changes to improve technical design  
and may do so without further notice.**

Parameters can vary in different applications. All operating parameters must be validated for each customer application by the customer. Should the buyer use Vishay Semiconductors products for any unintended or unauthorized application, the buyer shall indemnify Vishay Semiconductors against all claims, costs, damages, and expenses, arising out of, directly or indirectly, any claim of personal damage, injury or death associated with such unintended or unauthorized use.

Vishay Semiconductor GmbH, P.O.B. 3535, D-74025 Heilbronn, Germany  
Telephone: 49 (0)7131 67 2831, Fax number: 49 (0)7131 67 2423