

## TELUX™

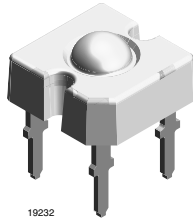

### FEATURES

- Utilizing one of the world's brightest (AS) AlInGaP technologies
- High luminous flux
- Supreme heat dissipation:  $R_{thJP}$  is 90 K/W
- High operating temperature:  
 $T_{amb} = -40$  to  $+110$  °C
- Meets SAE and ECE color requirements for the automobile industry for color red
- Packed in tubes for automatic insertion
- Luminous flux, forward voltage and color categorized for each tube
- Small mechanical tolerances allow precise usage of external reflectors or lightguides
- Lead (Pb)-free device
- Component in accordance to RoHS 2002/95/EC and WEEE 2002/96/EC
- Compatible with wave solder processes acc. to CECC 00802 and J-STD-020C
- ESD-withstand voltage:  
up to 2 kV according to JESD22-A114-B



### DESCRIPTION

The TELUX™ series is a clear, non diffused LED for applications where supreme luminous flux is required. It is designed in an industry standard 7.62 mm square package utilizing highly developed (AS) AlInGaP technology.

The supreme heat dissipation of TELUX™ allows applications at high ambient temperatures.

All packing units are binned for luminous flux, forward voltage and color to achieve the most homogenous light appearance in application.

SAE and ECE color requirements for automobile application are available for color red.

### APPLICATIONS

- Exterior lighting
- Dashboard illumination
- Tail-, Stop - and Turn Signals of motor vehicles
- Replaces small incandescent lamps
- Traffic signals and signs

### PARTS TABLE

PART	COLOR, LUMINOUS INTENSITY	ANGLE OF HALF INTENSITY ( $\pm \varphi$ )	TECHNOLOGY
TLWR8600	Red, $\phi_V = 3000$ mlm (typ.)	30°	AlInGaP on GaAs
TLWY8600	Yellow, $\phi_V = 3000$ mlm (typ.)	30°	AlInGaP on GaAs



<b>ABSOLUTE MAXIMUM RATINGS<sup>1)</sup>, TLWR8600, TLWY8600</b>				
PARAMETER	TEST CONDITION	SYMBOL	VALUE	UNIT
Reverse voltage <sup>2)</sup>	$I_R = 100 \mu\text{A}$	$V_R$	10	V
DC Forward current	$T_{\text{amb}} \leq 85 \text{ }^\circ\text{C}$	$I_F$	70	mA
Surge forward current	$t_p \leq 10 \mu\text{s}$	$I_{\text{FSM}}$	1	A
Power dissipation		$P_V$	187	mW
Junction temperature		$T_j$	125	$^\circ\text{C}$
Operating temperature range		$T_{\text{amb}}$	- 40 to + 110	$^\circ\text{C}$
Storage temperature range		$T_{\text{stg}}$	- 55 to + 110	$^\circ\text{C}$
Soldering temperature	$t \leq 5 \text{ s}$ , 1.5 mm from body preheat temperature 100 $^\circ\text{C}$ / 30 sec.	$T_{\text{sd}}$	260	$^\circ\text{C}$
Thermal resistance junction/ambient	with cathode heatsink of 70 mm <sup>2</sup>	$R_{\text{thJA}}$	200	K/W
Thermal resistance junction/pin		$R_{\text{thJP}}$	90	K/W

Note:

1)  $T_{\text{amb}} = 25 \text{ }^\circ\text{C}$  unless otherwise specified

2) Driving the LED in reverse direction is suitable for a short term application

<b>OPTICAL AND ELECTRICAL CHARACTERISTICS<sup>1)</sup>, TLWR8600, RED</b>						
PARAMETER	TEST CONDITION	SYMBOL	MIN	TYP.	MAX	UNIT
Total flux	$I_F = 70 \text{ mA}$ , $R_{\text{thJA}} = 200 \text{ }^\circ\text{K/W}$	$\phi_V$	2000	3000		mlm
Luminous intensity/Total flux	$I_F = 70 \text{ mA}$ , $R_{\text{thJA}} = 200 \text{ }^\circ\text{K/W}$	$I_V/\phi_V$		0.8		mcd/mlm
Dominant wavelength	$I_F = 70 \text{ mA}$ , $R_{\text{thJA}} = 200 \text{ }^\circ\text{K/W}$	$\lambda_d$	611	615	634	nm
Peak wavelength	$I_F = 70 \text{ mA}$ , $R_{\text{thJA}} = 200 \text{ }^\circ\text{K/W}$	$\lambda_p$		624		nm
Angle of half intensity	$I_F = 70 \text{ mA}$ , $R_{\text{thJA}} = 200 \text{ }^\circ\text{K/W}$	$\varphi$		$\pm 30$		deg
Total included angle	90 % of Total Flux Captured	$\varphi_{0.9V}$		75		deg
Forward voltage	$I_F = 70 \text{ mA}$ , $R_{\text{thJA}} = 200 \text{ }^\circ\text{K/W}$	$V_F$	1.83	2.2	2.67	V
Reverse voltage	$I_R = 10 \mu\text{A}$	$V_R$	10	20		V
Junction capacitance	$V_R = 0$ , $f = 1 \text{ MHz}$	$C_j$		17		pF

Note:

1)  $T_{\text{amb}} = 25 \text{ }^\circ\text{C}$  unless otherwise specified

<b>OPTICAL AND ELECTRICAL CHARACTERISTICS<sup>1)</sup>, TLWY8600, YELLOW</b>						
PARAMETER	TEST CONDITION	SYMBOL	MIN	TYP.	MAX	UNIT
Total flux	$I_F = 70 \text{ mA}$ , $R_{\text{thJA}} = 200 \text{ }^\circ\text{K/W}$	$\phi_V$	2000	3000		mlm
Luminous intensity/Total flux	$I_F = 70 \text{ mA}$ , $R_{\text{thJA}} = 200 \text{ }^\circ\text{K/W}$	$I_V/\phi_V$		0.8		mcd/mlm
Dominant wavelength	$I_F = 70 \text{ mA}$ , $R_{\text{thJA}} = 200 \text{ }^\circ\text{K/W}$	$\lambda_d$	585	590	597	nm
Peak wavelength	$I_F = 70 \text{ mA}$ , $R_{\text{thJA}} = 200 \text{ }^\circ\text{K/W}$	$\lambda_p$		594		nm
Angle of half intensity	$I_F = 70 \text{ mA}$ , $R_{\text{thJA}} = 200 \text{ }^\circ\text{K/W}$	$\varphi$		$\pm 30$		deg
Total included angle	90 % of Total Flux Captured	$\varphi_{0.9V}$		75		deg
Forward voltage	$I_F = 70 \text{ mA}$ , $R_{\text{thJA}} = 200 \text{ }^\circ\text{K/W}$	$V_F$	1.83	2.1	2.67	V
Reverse voltage	$I_R = 10 \mu\text{A}$	$V_R$	10	15		V
Junction capacitance	$V_R = 0$ , $f = 1 \text{ MHz}$	$C_j$		17		pF

Note:

1)  $T_{\text{amb}} = 25 \text{ }^\circ\text{C}$  unless otherwise specified

LUMINOUS FLUX CLASSIFICATION		
GROUP	LUMINOUS FLUX [MLM]	
	MIN	MAX
D	2000	3000
E	2500	3600
F	3000	4200
G	3500	4800
H	4000	6100
I	5000	7300
K	6000	9700
L	7000	12200
M	8000	15000

Note:

Luminous intensity is tested at a current pulse duration of 25 ms and an accuracy of  $\pm 11\%$ .

The above type numbers represent the order groups which include only a few brightness groups. Only one group will be shipped on each tube (there will be no mixing of two groups on each tube).

In order to ensure availability, single brightness groups will be not orderable.

In a similar manner for colors where wavelength groups are measured and binned, single wavelength groups will be shipped in any one tube.

In order to ensure availability, single wavelength groups will not be orderable.

COLOR CLASSIFICATION				
GROUP	DOM. WAVELENGTH (NM)			
	YELLOW		RED	
	MIN.	MAX.	MIN.	MAX.
0	585	588		
1	587	591	611	618
2	589	594	614	622
3	592	597	616	634

Note:

Wavelengths are tested at a current pulse duration of 25 ms and an accuracy of  $\pm 1$  nm.

### TYPICAL CHARACTERISTICS

$T_{amb} = 25\text{ }^{\circ}\text{C}$  unless otherwise specified

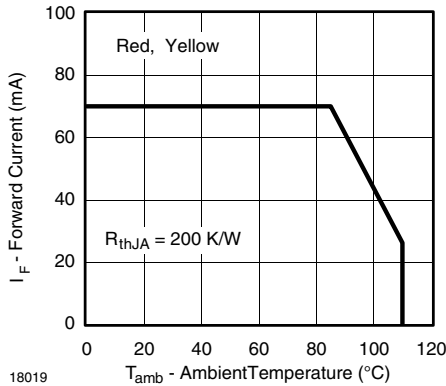

Figure 1. Forward Current vs. Ambient Temperature

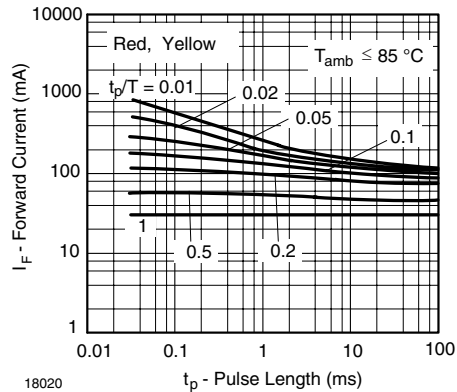

Figure 2. Forward Current vs. Pulse Length

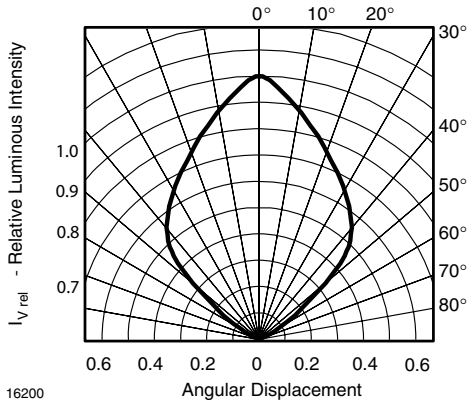

Figure 3. Rel. Luminous Intensity vs. Angular Displacement

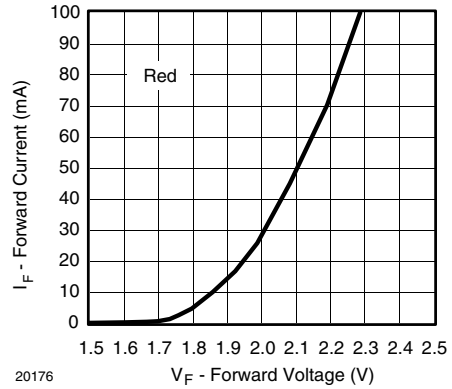

Figure 6. Forward Current vs. Forward Voltage

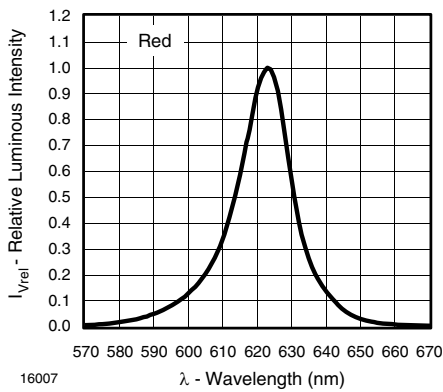

Figure 4. Relative Intensity vs. Wavelength

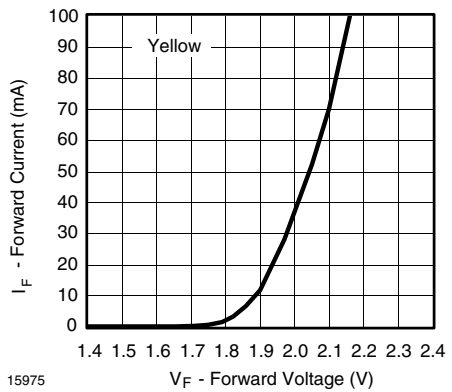

Figure 7. Forward Current vs. Forward Voltage

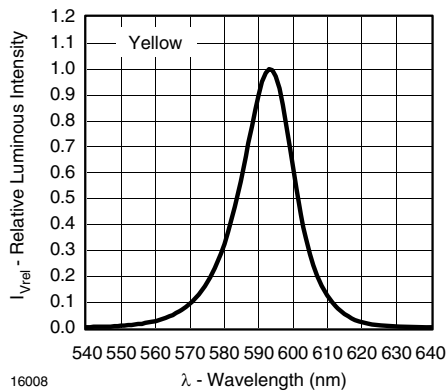

Figure 5. Relative Intensity vs. Wavelength

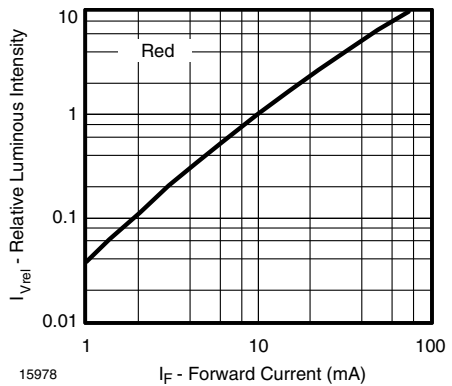

Figure 8. Relative Luminous Flux vs. Forward Current

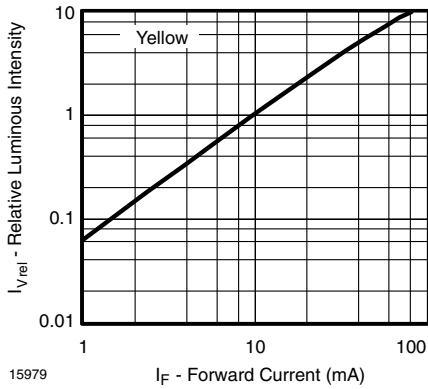

Figure 9. Relative Luminous Flux vs. Forward Current

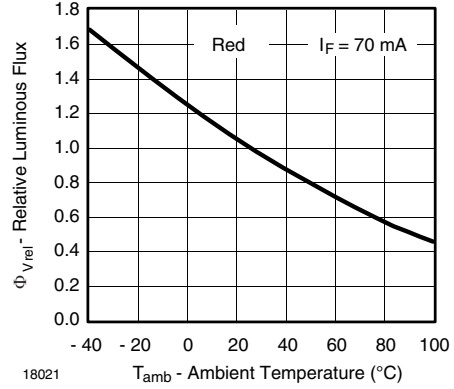

Figure 12. Rel. Luminous Flux vs. Ambient Temperature

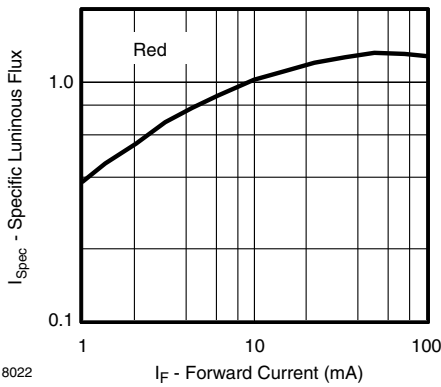

Figure 10. Specific Luminous Flux vs. Forward Current

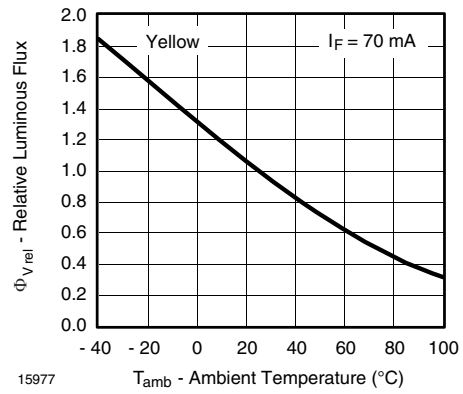

Figure 13. Rel. Luminous Flux vs. Ambient Temperature

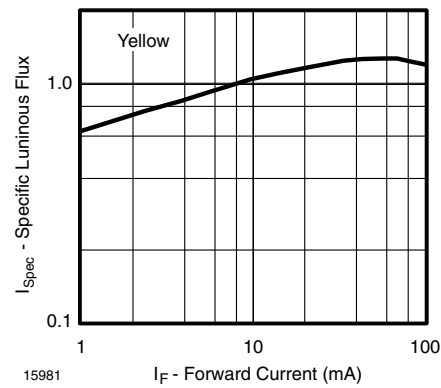

Figure 11. Specific Luminous Flux vs. Forward Current

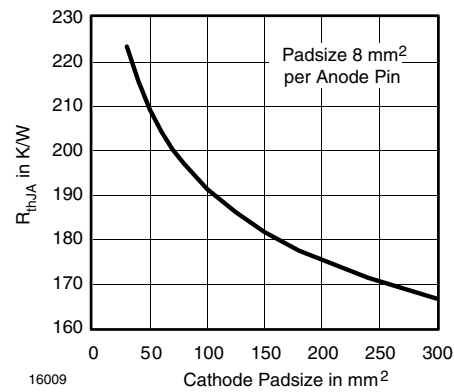

Figure 14. Thermal Resistance Junction Ambient vs. Cathode Pads Size

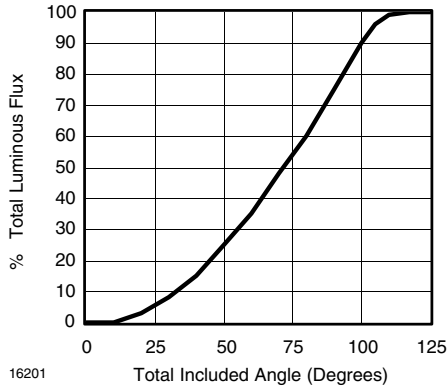
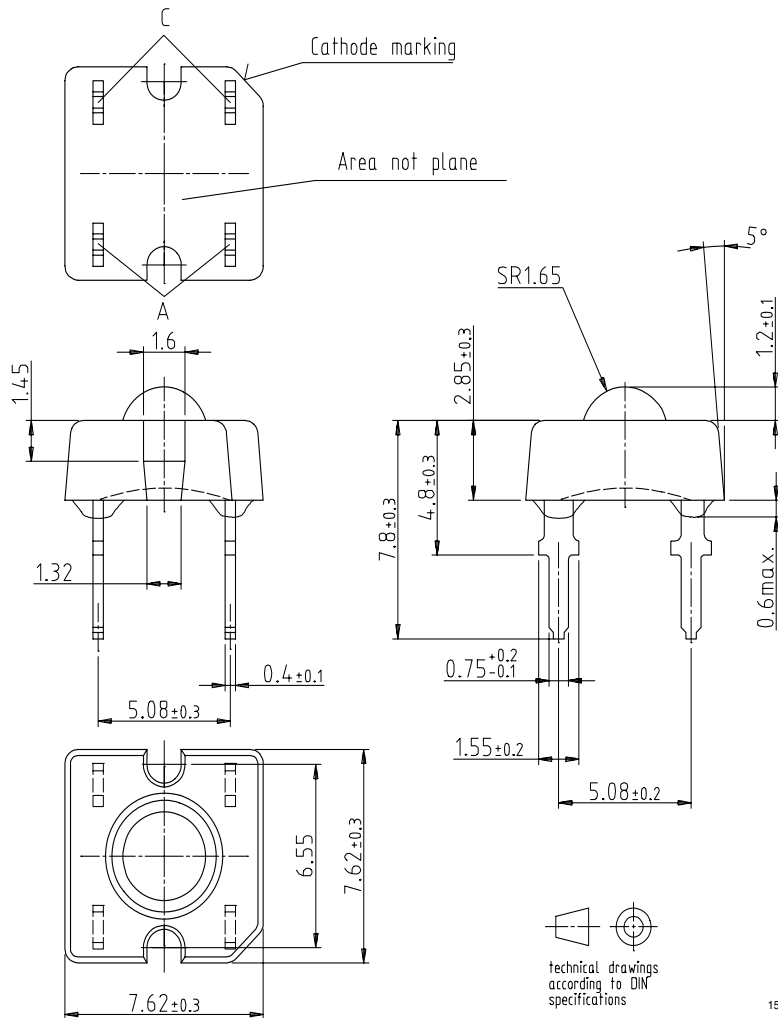

Figure 15. Percentage Total Luminous Flux vs. Total Included Angle for 90° emission angle

**PACKAGE DIMENSIONS IN MM**



15984



## **Ozone Depleting Substances Policy Statement**

It is the policy of Vishay Semiconductor GmbH to

1. Meet all present and future national and international statutory requirements.
2. Regularly and continuously improve the performance of our products, processes, distribution and operating systems with respect to their impact on the health and safety of our employees and the public, as well as their impact on the environment.

It is particular concern to control or eliminate releases of those substances into the atmosphere which are known as ozone depleting substances (ODSs).

The Montreal Protocol (1987) and its London Amendments (1990) intend to severely restrict the use of ODSs and forbid their use within the next ten years. Various national and international initiatives are pressing for an earlier ban on these substances.

Vishay Semiconductor GmbH has been able to use its policy of continuous improvements to eliminate the use of ODSs listed in the following documents.

1. Annex A, B and list of transitional substances of the Montreal Protocol and the London Amendments respectively
2. Class I and II ozone depleting substances in the Clean Air Act Amendments of 1990 by the Environmental Protection Agency (EPA) in the USA
3. Council Decision 88/540/EEC and 91/690/EEC Annex A, B and C (transitional substances) respectively.

Vishay Semiconductor GmbH can certify that our semiconductors are not manufactured with ozone depleting substances and do not contain such substances.

We reserve the right to make changes to improve technical design  
and may do so without further notice.

Parameters can vary in different applications. All operating parameters must be validated for each customer application by the customer. Should the buyer use Vishay Semiconductors products for any unintended or unauthorized application, the buyer shall indemnify Vishay Semiconductors against all claims, costs, damages, and expenses, arising out of, directly or indirectly, any claim of personal damage, injury or death associated with such unintended or unauthorized use.

Vishay Semiconductor GmbH, P.O.B. 3535, D-74025 Heilbronn, Germany



## Notice

Specifications of the products displayed herein are subject to change without notice. Vishay Intertechnology, Inc., or anyone on its behalf, assumes no responsibility or liability for any errors or inaccuracies.

Information contained herein is intended to provide a product description only. No license, express or implied, by estoppel or otherwise, to any intellectual property rights is granted by this document. Except as provided in Vishay's terms and conditions of sale for such products, Vishay assumes no liability whatsoever, and disclaims any express or implied warranty, relating to sale and/or use of Vishay products including liability or warranties relating to fitness for a particular purpose, merchantability, or infringement of any patent, copyright, or other intellectual property right.

The products shown herein are not designed for use in medical, life-saving, or life-sustaining applications. Customers using or selling these products for use in such applications do so at their own risk and agree to fully indemnify Vishay for any damages resulting from such improper use or sale.