

0.37 Ω , Low THD and Capacitance, Dual DPDT / Quad SPDT Analog Switch

DESCRIPTION

The DG2525, is a four-channel single-pole double-throw (SPDT) analog switch with two control inputs. It is also known as a two-channel double-pole double-throw (DPDT) configuration. The part is designed to operate from 1.8 V to 5.5 V single power rail. All switches conduct equally well in both directions, offering rail to rail signal switching and can be used both as multiplexers as well as de-multiplexers.

The DG2525 offers low leakage, parasitic capacitance, and highly matched low and flat switch resistance over the full signal range. It features break-before-make switching and low control logic threshold. The part exhibits high bandwidth and excellent total harmonic distortion (THD). It is ideal for both analog and digital signal switching in space constrain applications requiring high performance and efficient use of board space.

The DG2525 comes in a small miniQFN-16 lead package of 2.6 mm x 1.8 mm x 0.55 mm.

BENEFITS

- Low and flat resistance
- Excellent total harmonic distortion
- Low leakage and parasitic capacitance
- Low voltage control interface

FEATURES

- 1.8 V to 5.5 V single supply operation
- Low resistance: 0.4 Ω /typ. at 2.7 V
- Highly flat and matched R_{ON}
- Low parasitic capacitance, $C_{ON} = 26$ pF, $C_{OFF} = 14.5$ pF
- Switch off leakage: 5 pA at $V_+ = 3.3$ V, 40 pA at $V_+ = 5.5$ V
- High bandwidth: 310 MHz
- -100 dB THD + N at 1 kHz, 0.9 V_{RMS} , $R_{LOAD} = 32$ Ω
- Guaranteed logic high 1.2 V, logic low 0.3 V
- Break before make switching
- Signal swing over V_+ capable
- Power down protection
- Latch up current: 300 mA (JESD78)
- ESD / HBM: > 6 kV
- Material categorization: for definitions of compliance please see www.vishay.com/doc?99912

RoHS
COMPLIANT

APPLICATIONS

- Smart phones and tablets
- Portable instrumentation
- Audio and video signal switching
- Modems and peripherals
- Data storage
- Wireless pins
- Relay replacement

FUNCTIONAL BLOCK DIAGRAM AND PIN CONFIGURATION

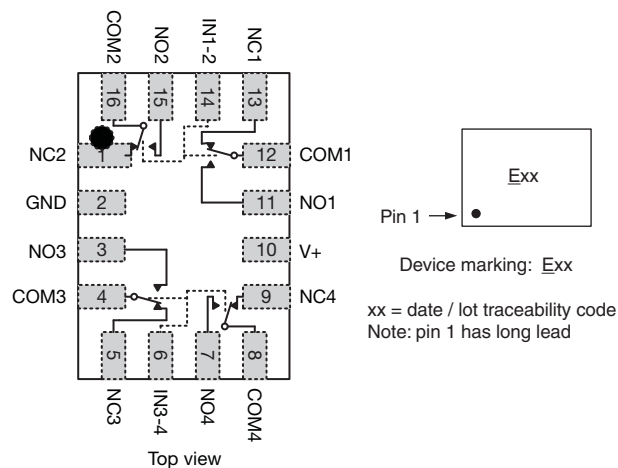

TRUTH TABLE		
LOGIC	NC1, 2, 3, and 4	NO1, 2, 3, and 4
0	On	Off
1	Off	On



ORDERING INFORMATION			
TEMPERATURE RANGE	PACKAGE	PART NUMBER	MIN. ORDER / PACK. QUANTITY
-40 °C to +85 °C lead (Pb)-free	miniQFN-16	DG2525DN-T1-GE4	Tape and reel, 3000 units

ABSOLUTE MAXIMUM RATINGS (T _A = 25 °C, unless otherwise noted)				
PARAMETER		SYMBOL	LIMIT	UNIT
Reference to GND	V+		-0.3 to +6	V
	IN, COM, NC, NO ^a		-0.3 to (V+ + 0.3)	
Current (any terminal except NO, NC, or COM)			30	mA
Continuous current (NO, NC, or COM)			± 300	
Peak current (pulsed at 1 ms, 10 % duty cycle)			± 500	
Storage temperature (D suffix)			-65 to +150	°C
Package solder reflow conditions ^d	miniQFN-16		250	
Power dissipation (packages) ^b	miniQFN-16 ^c		525	mW

Notes

- a. Signals on NC, NO, or COM, or IN exceeding V+ will be clamped by internal diodes. Limit forward diode current to maximum current ratings.
- b. All leads welded or soldered to PC board.
- c. Derate 6.6 mW/°C above 70 °C.
- d. Manual soldering with iron is not recommended for leadless components. The miniQFN-16 is a leadless package. The end of the lead terminal is exposed copper (not plated) as a result of the singulation process in manufacturing. A solder fillet at the exposed copper lip cannot be guaranteed and is not required to ensure adequate bottom side solder interconnection.

Stresses beyond those listed under "Absolute Maximum Ratings" may cause permanent damage to the device. These are stress ratings only, and functional operation of the device at these or any other conditions beyond those indicated in the operational sections of the specifications is not implied. Exposure to absolute maximum rating conditions for extended periods may affect device reliability.



SPECIFICATIONS (V+ = 3 V)								
PARAMETER	SYMBOL	TEST CONDITIONS unless otherwise specified V+ = 3 V, ± 10 %, VIN = 0.5 or 1.4 V e	TEMP. a	LIMITS -40 °C to +85 °C			UNIT	
				MIN. b	TYP. c	MAX. b		
Analog Switch								
Analog signal range d	VNO, VNC, VCOM		Full	0	-	V+	V	
On-resistance	RON	V+ = 2.7 V, VCOM = 0 to 2.7 V, INO, INC = 100 mA	Room	-	0.37	0.5	Ω	
			Full	-	-	0.6		
RON flatness d	RON flatness	V+ = 2.7 V, VCOM = 0 to V+, INO, INC = 100 mA	Full	-	0.03	0.08	Ω	
RON match d	ΔRON		Room	-	0.05	-		
Switch off leakage current	INO(off), INC(off)	V+ = 5.5 V, VNO, VNC = 0.5 V / 4 V, VCOM = 4 V / 0.5 V	Room	-1	0.04	1	nA	
			Full	-5	-	5		
	Room		-1	0.17	1			
	Full		-5	-	5			
Channel-on leakage current	ICOM(on)	V+ = 5.5 V, VNO, VNC = VCOM = 0.5 V / 4 V	Room	-1	0.17	1	nA	
	Full		-5	-	5			
Digital Control								
Input high voltage	VINH		Full	1.2	-	-	V	
Input low voltage	VINL			-	-	0.3		
Input capacitance	CIN		Full	-	5	-	pF	
Input current	IINL or IINH	VIN = 0 or V+	Full	-1	-	1	μA	
Dynamic Characteristics								
Turn-on time	tON	VNO or VNC = 1.5 V, RL = 50 Ω, CL = 35 pF	Room	-	38	60	μs	
			Full	-	-	70		
Turn-off time	tOFF		Room	-	0.43	1		
			Full	-	-	3		
Break-before-make time	td		Full	1	-	-		
Charge injection d	QINJ	CL = 1 nF, VGEN = 1.5 V, RGEN = 0 Ω	Room	-	-19	-	pC	
-3 dB bandwidth	BW	RL = 50 Ω, CL = 5 pF	Room	-	310	-	MHz	
Off-isolation d	OIRR	RL = 50 Ω, CL = 5 pF, f = 100 kHz	Room	-	-82	-	dB	
		RL = 50 Ω, CL = 5 pF, f = 1 MHz		-	-55	-		
Crosstalk d, f	XTALK	RL = 50 Ω, CL = 5 pF, f = 100 kHz		-	-89	-		
		RL = 50 Ω, CL = 5 pF, f = 1 MHz		-	-61	-		
Total harmonic distortion plus noise	THD + N	2.5 V, signal peak to peak voltage RL = 32 Ω, f = 1 kHz			-	-100		-
NO, NC off capacitance d	CNO(off)	f = 1 MHz		Room	-	14.5		-
	CNC(off)		-		14.5	-		
Channel-on capacitance d	CNO(on)		-		26	-		
	CNC(on)		-		26	-		
Power Supply								
Power supply range	V+			1.8	-	5.5	V	
Power supply current	I+	VIN = 0 or V+	Full	-	29	60	μA	

Notes

- a. Room = 25 °C, full = as determined by the operating suffix.
- b. The algebraic convention whereby the most negative value is a minimum and the most positive a maximum, is used in this data sheet.
- c. Typical values are for design aid only, not guaranteed nor subject to production testing.
- d. Guarantee by design, not subjected to production test.
- e. VIN = input voltage to perform proper function.
- f. Crosstalk measured between channels.



TYPICAL CHARACTERISTICS ($T_A = 25\text{ }^\circ\text{C}$, unless otherwise noted)

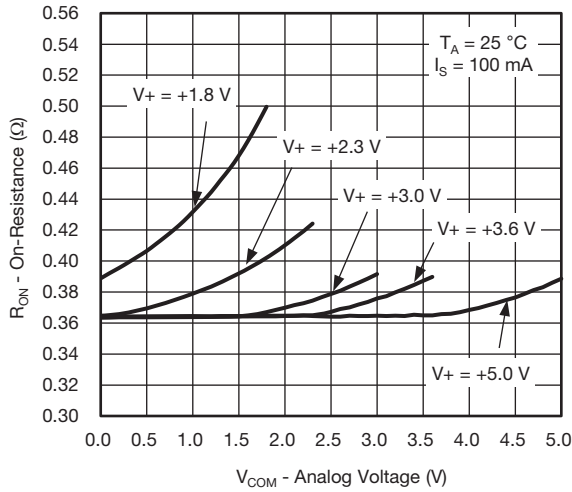

RON vs. VCOM and Supply Voltage

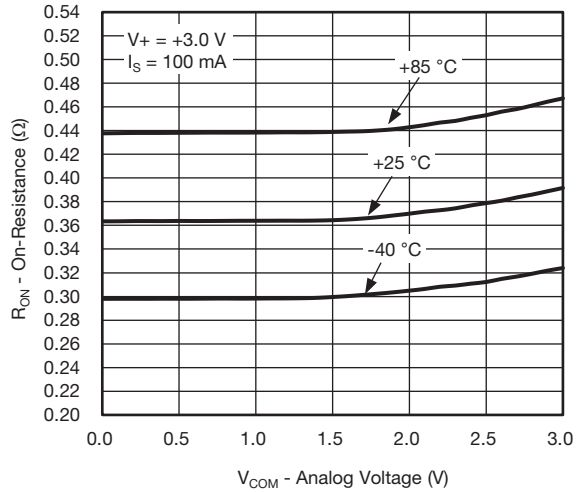

RON vs. Analog Voltage and Temperature

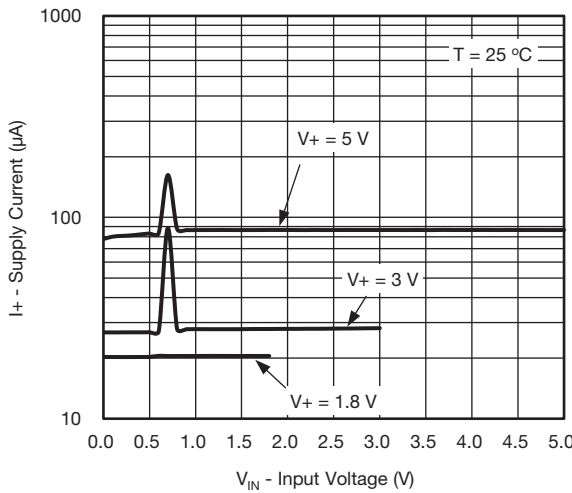

Supply Current vs. Input Voltage

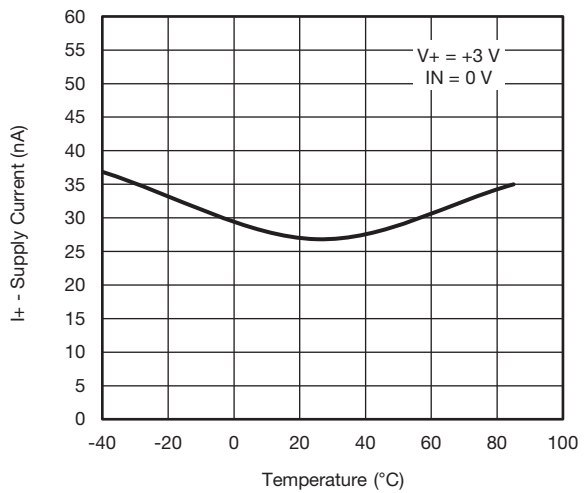

Supply Current vs. Temperature

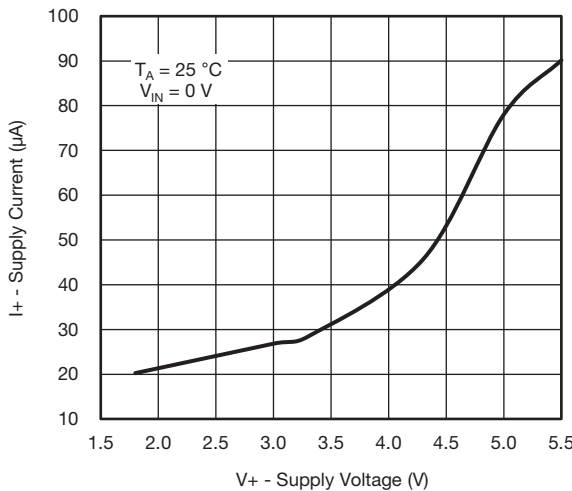

Supply Current vs. Supply Voltage

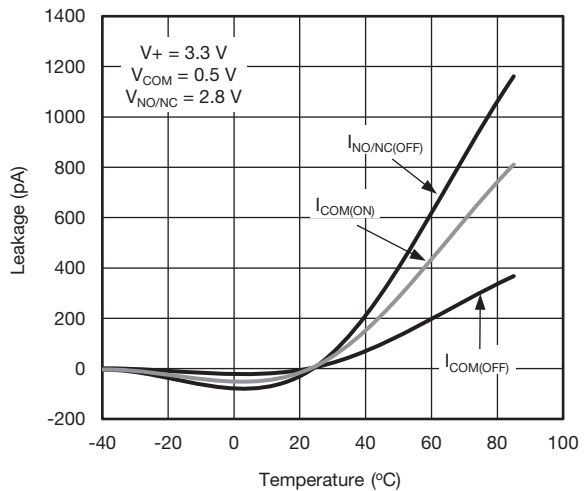

Leakage Current vs. Temperature

TYPICAL CHARACTERISTICS ($T_A = 25\text{ }^\circ\text{C}$, unless otherwise noted)

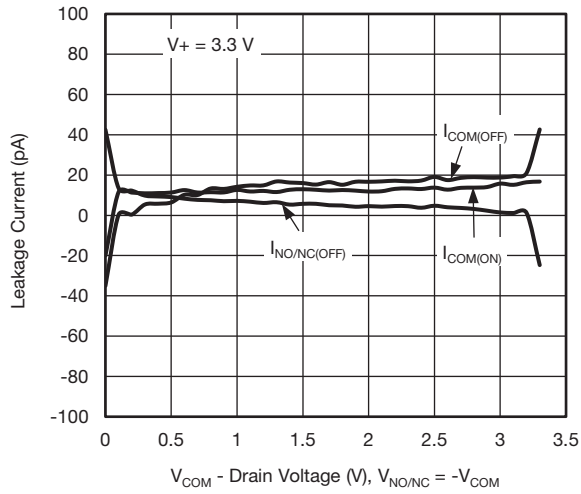

Leakage Current vs. Drain Voltage

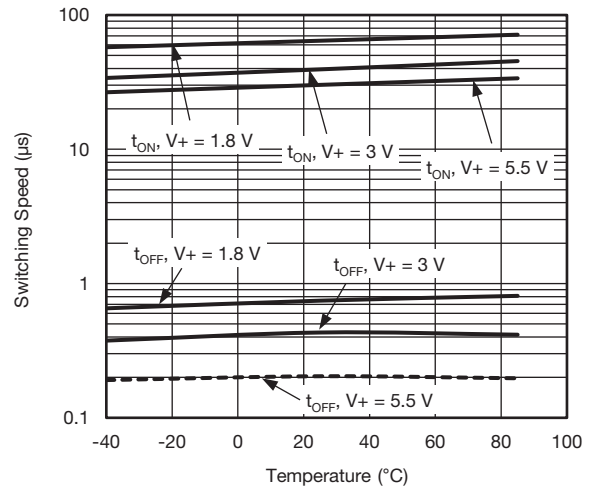

Switching Time vs. Temperature

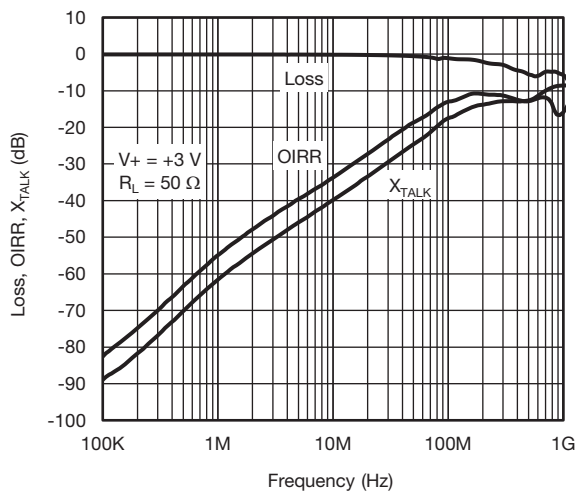

Insertion Loss, Off-Isolation Crosstalk vs. Frequency

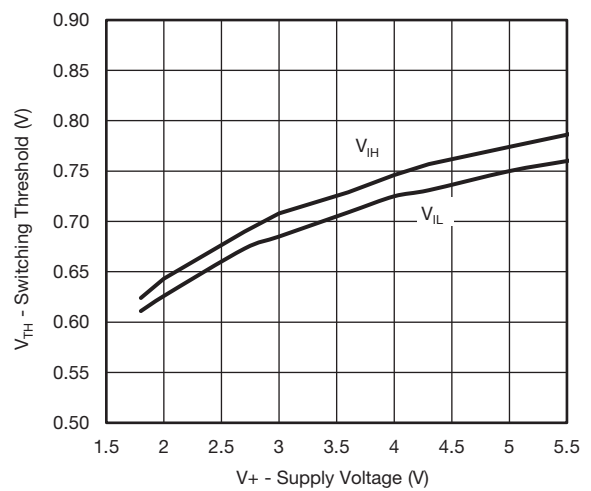

Switching Threshold vs. Supply Voltage



TYPICAL CHARACTERISTICS ($T_A = 25\text{ }^\circ\text{C}$, unless otherwise noted)

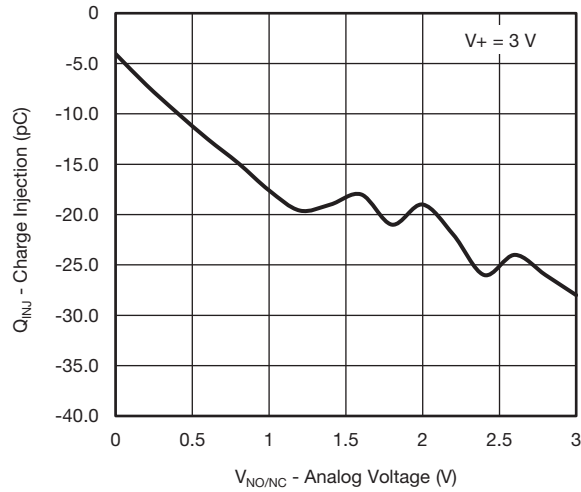

Charge Injection vs. Analog Voltage

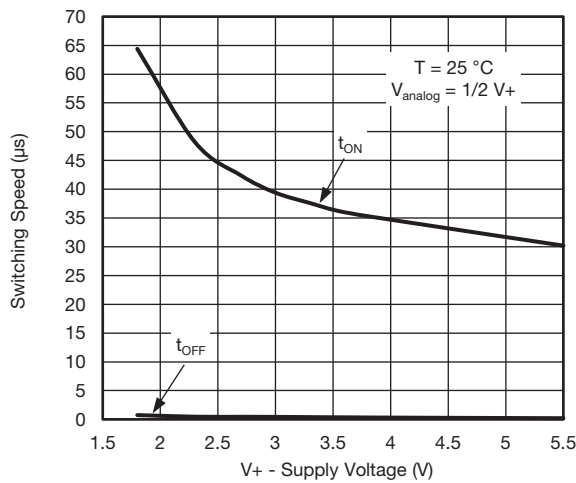

Switching Time vs. Supply Voltage

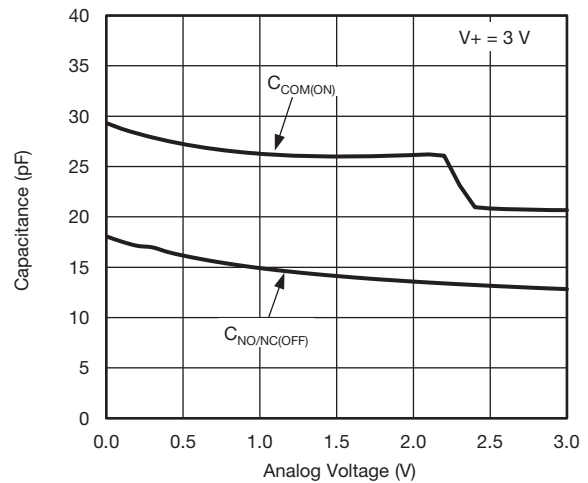

Capacitance vs. Analog Voltage

TEST CIRCUITS

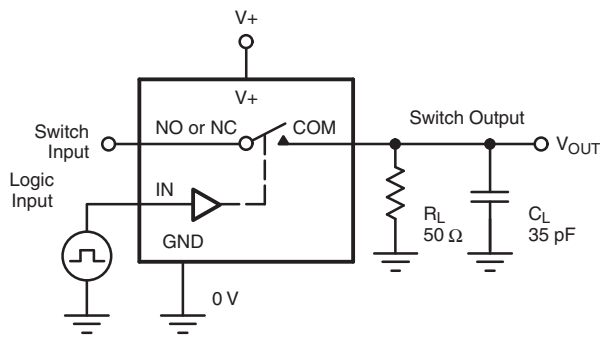

C_L (includes fixture and stray capacitance)

$$V_{OUT} = V_{COM} \left(\frac{R_L}{R_L + R_{ON}} \right)$$

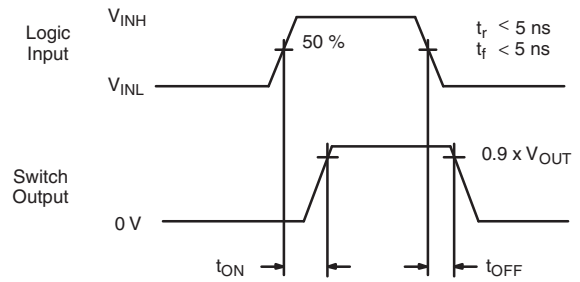

Logic "1" = Switch On
Logic input waveforms inverted for switches that have the opposite logic sense.

Fig. 1 - Switching Time

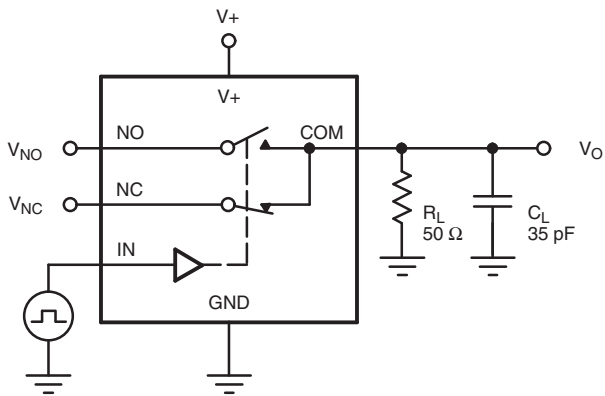

C_L (includes fixture and stray capacitance)

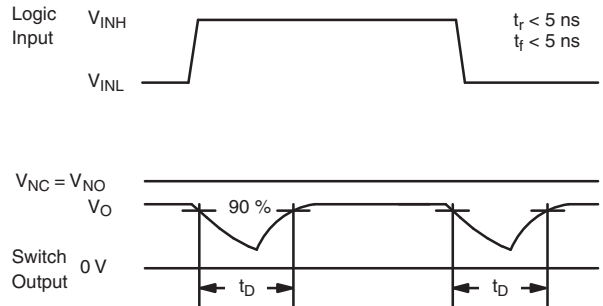
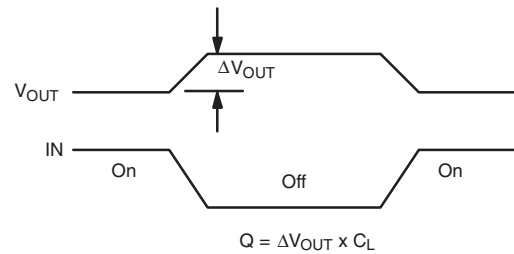
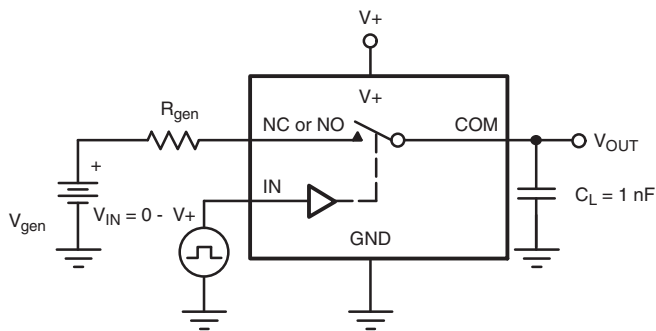
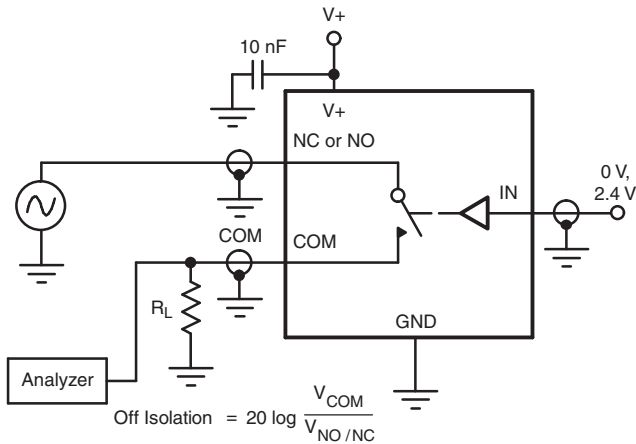
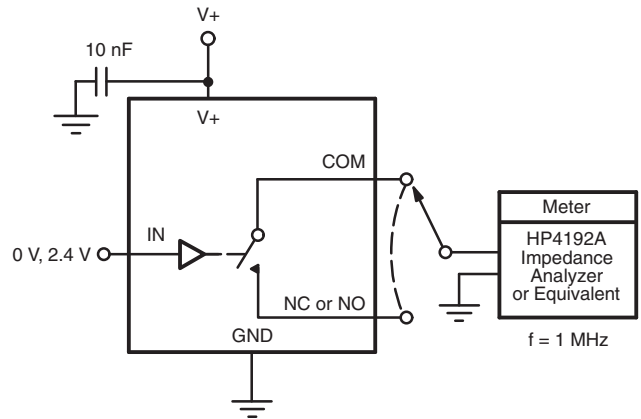

Fig. 2 - Break-Before-Make Interval



IN depends on switch configuration: input polarity determined by sense of switch.

Fig. 3 - Charge Injection

Fig. 4 - Off-Isolation

Fig. 5 - Channel Off / On Capacitance

Vishay Siliconix maintains worldwide manufacturing capability. Products may be manufactured at one of several qualified locations. Reliability data for Silicon Technology and Package Reliability represent a composite of all qualified locations. For related documents such as package/tape drawings, part marking, and reliability data, see www.vishay.com/ppg?78295.

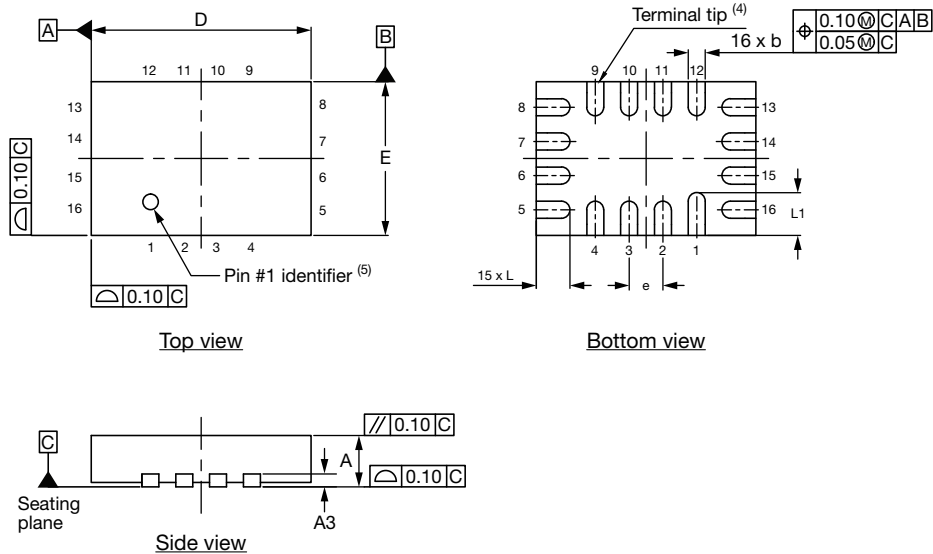
Thin miniQFN16 Case Outline



DIMENSIONS	MILLIMETERS ⁽¹⁾			INCHES		
	MIN.	NOM.	MAX.	MIN.	NOM.	MAX.
A	0.50	0.55	0.60	0.020	0.022	0.024
A1	0	-	0.05	0	-	0.002
A3	0.15 ref.			0.006 ref.		
b	0.15	0.20	0.25	0.006	0.008	0.010
D	2.50	2.60	2.70	0.098	0.102	0.106
e	0.40 BSC			0.016 BSC		
E	1.70	1.80	1.90	0.067	0.071	0.075
L	0.35	0.40	0.45	0.014	0.016	0.018
L1	0.45	0.50	0.55	0.018	0.020	0.022
N ⁽³⁾	16			16		
Nd ⁽³⁾	4			4		
Ne ⁽³⁾	4			4		

Notes

- (1) Use millimeters as the primary measurement.
- (2) Dimensioning and tolerances conform to ASME Y14.5M. - 1994.
- (3) N is the number of terminals. Nd and Ne is the number of terminals in each D and E site respectively.
- (4) Dimensions b applies to plated terminal and is measured between 0.15 mm and 0.30 mm from terminal tip.
- (5) The pin 1 identifier must be existed on the top surface of the package by using identification mark or other feature of package body.
- (6) Package warpage max. 0.05 mm.

ECN: T16-0226-Rev. B, 09-May-16
DWG: 6023

RECOMMENDED MINIMUM PADS FOR MINI QFN 16L



Mounting Footprint
Dimensions in mm (inch)



Disclaimer

ALL PRODUCT, PRODUCT SPECIFICATIONS AND DATA ARE SUBJECT TO CHANGE WITHOUT NOTICE TO IMPROVE RELIABILITY, FUNCTION OR DESIGN OR OTHERWISE.

Vishay Intertechnology, Inc., its affiliates, agents, and employees, and all persons acting on its or their behalf (collectively, "Vishay"), disclaim any and all liability for any errors, inaccuracies or incompleteness contained in any datasheet or in any other disclosure relating to any product.

Vishay makes no warranty, representation or guarantee regarding the suitability of the products for any particular purpose or the continuing production of any product. To the maximum extent permitted by applicable law, Vishay disclaims (i) any and all liability arising out of the application or use of any product, (ii) any and all liability, including without limitation special, consequential or incidental damages, and (iii) any and all implied warranties, including warranties of fitness for particular purpose, non-infringement and merchantability.

Statements regarding the suitability of products for certain types of applications are based on Vishay's knowledge of typical requirements that are often placed on Vishay products in generic applications. Such statements are not binding statements about the suitability of products for a particular application. It is the customer's responsibility to validate that a particular product with the properties described in the product specification is suitable for use in a particular application. Parameters provided in datasheets and / or specifications may vary in different applications and performance may vary over time. All operating parameters, including typical parameters, must be validated for each customer application by the customer's technical experts. Product specifications do not expand or otherwise modify Vishay's terms and conditions of purchase, including but not limited to the warranty expressed therein.

Except as expressly indicated in writing, Vishay products are not designed for use in medical, life-saving, or life-sustaining applications or for any other application in which the failure of the Vishay product could result in personal injury or death. Customers using or selling Vishay products not expressly indicated for use in such applications do so at their own risk. Please contact authorized Vishay personnel to obtain written terms and conditions regarding products designed for such applications.

No license, express or implied, by estoppel or otherwise, to any intellectual property rights is granted by this document or by any conduct of Vishay. Product names and markings noted herein may be trademarks of their respective owners.