

Ultrabright LED, \varnothing 5 mm Untinted Non-Diffused

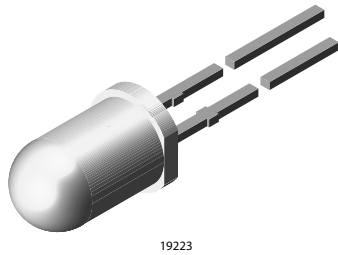

FEATURES

- Untinted non diffused lens
- Utilizing ultrabright AllnGaP (AS)
- High luminous intensity
- High operating temperature:
 T_j (chip junction temperature) up to 125 °C for AllnGaP devices
- Luminous intensity and color categorized for each packing unit
- ESD-withstand voltage:
 up to 2 kV according to JESD22-A114-B
- Lead (Pb)-free component
- Component in accordance to RoHS 2002/95/EC and WEEE 2002/96/EC



DESCRIPTION

The TLC.51.. series is a clear, non diffused 5 mm LED for high end applications where supreme luminous intensity required.

These lamps with clear untinted plastic case utilize the highly developed ultrabright AllnGaP (AS).

The lens and the viewing angle is optimized to achieve best performance of light output and visibility.

APPLICATIONS

- Interior and exterior lighting
- Outdoor LED panels
- Instrumentation and front panel indicators
- Central high mounted stop lights (CHMSL) for motor vehicles
- Replaces incandescent lamps
- Traffic signals
- Light guide design

PARTS TABLE

PART	COLOR, LUMINOUS INTENSITY	ANGLE OF HALF INTENSITY ($\pm \phi$)	TECHNOLOGY
TLCR5100	Red, $I_V \geq 4300$ mcd	9°	AllnGaP on GaAs
TLCY5100	Yellow, $I_V \geq 3200$ mcd	9°	AllnGaP on GaAs
TLCY5101	Yellow, $I_V = (5750 \text{ to } 20000)$ mcd	9°	AllnGaP on GaAs
TLCS5100	Super red, $I_V \geq 2400$ mcd	9°	AllnGaP on GaAs
TLCO5100	Soft orange, $I_V \geq 4300$ mcd	9°	AllnGaP on GaAs
TLCYG5100	Yellow green, $I_V \geq 1350$ mcd	9°	AllnGaP on GaAs
TLCPG5100	Pure green, $I_V \geq 430$ mcd	9°	AllnGaP on GaAs

ABSOLUTE MAXIMUM RATINGS¹⁾, TLCS/R/O/Y/YG/PG5100				
Parameter	Test condition	Symbol	Value	Unit
Reverse voltage ²⁾		V_R	5	V
DC Forward current	$T_{amb} \leq 85\text{ }^\circ\text{C}$	I_F	50	mA
Surge forward current	$t_p \leq 10\text{ }\mu\text{s}$	I_{FSM}	1	A
Power dissipation		P_V	135	mW
Junction temperature		T_j	125	$^\circ\text{C}$
Operating temperature range		T_{amb}	- 40 to + 100	$^\circ\text{C}$
Storage temperature range		T_{stg}	- 40 to + 100	$^\circ\text{C}$
Soldering temperature	$t \leq 5\text{ s}$, 2 mm from body	T_{sd}	260	$^\circ\text{C}$
Thermal resistance junction/ambient		R_{thJA}	300	K/W

Note:

¹⁾ $T_{amb} = 25\text{ }^\circ\text{C}$ unless otherwise specified

²⁾ Driving the LED in reverse direction is suitable for a short term application

OPTICAL AND ELECTRICAL CHARACTERISTICS¹⁾, TLCS5100, SUPER RED							
PARAMETER	TEST CONDITION	PART	SYMBOL	MIN	TYP.	MAX	UNIT
Luminous intensity ²⁾	$I_F = 50\text{ mA}$	TLCS5100	I_v	2400	7500		mcd
Dominant wavelength	$I_F = 50\text{ mA}$		λ_d	626	630	638	nm
Peak wavelength	$I_F = 50\text{ mA}$		λ_p		641		nm
Spectral bandwidth at 50 % $I_{rel\ max}$	$I_F = 50\text{ mA}$		$\Delta\lambda$		20		nm
Angle of half intensity	$I_F = 50\text{ mA}$		φ		± 9		deg
Forward voltage	$I_F = 50\text{ mA}$		V_F		2.1	2.7	V
Reverse voltage	$I_R = 10\text{ }\mu\text{A}$		V_R	5			V
Temperature coefficient of V_F	$I_F = 50\text{ mA}$		TC_{V_F}		- 2		mV/K
Temperature coefficient of λ_d	$I_F = 50\text{ mA}$		TC_{λ_d}		0.04		nm/K

Note:

¹⁾ $T_{amb} = 25\text{ }^\circ\text{C}$ unless otherwise specified

²⁾ In one Packing Unit $I_{Vmax}/I_{Vmin} \leq 2.0$

OPTICAL AND ELECTRICAL CHARACTERISTICS¹⁾, TLCS5100, RED							
PARAMETER	TEST CONDITION	PART	SYMBOL	MIN	TYP.	MAX	UNIT
Luminous intensity ²⁾	$I_F = 50\text{ mA}$	TLCS5100	I_v	4300	11000		mcd
Dominant wavelength	$I_F = 50\text{ mA}$		λ_d	611	616	622	nm
Peak wavelength	$I_F = 50\text{ mA}$		λ_p		622		nm
Spectral bandwidth at 50 % $I_{rel\ max}$	$I_F = 50\text{ mA}$		$\Delta\lambda$		18		nm
Angle of half intensity	$I_F = 50\text{ mA}$		φ		± 9		deg
Forward voltage	$I_F = 50\text{ mA}$		V_F		2.1	2.7	V
Reverse voltage	$I_R = 10\text{ }\mu\text{A}$		V_R	5			V
Temperature coefficient of V_F	$I_F = 50\text{ mA}$		TC_{V_F}		- 3.5		mV/K
Temperature coefficient of λ_d	$I_F = 50\text{ mA}$		TC_{λ_d}		0.05		nm/K

Note:

¹⁾ $T_{amb} = 25\text{ }^\circ\text{C}$ unless otherwise specified

²⁾ In one Packing Unit $I_{Vmax}/I_{Vmin} \leq 2.0$



OPTICAL AND ELECTRICAL CHARACTERISTICS¹⁾, TLC05100, SOFT ORANGE							
PARAMETER	TEST CONDITION	PART	SYMBOL	MIN	TYP.	MAX	UNIT
Luminous intensity ²⁾	$I_F = 50 \text{ mA}$	TLC05100	I_V	4300	12000		mcd
Dominant wavelength	$I_F = 50 \text{ mA}$		λ_d	600	605	611	nm
Peak wavelength	$I_F = 50 \text{ mA}$		λ_p		611		nm
Spectral bandwidth at 50 % $I_{rel \text{ max}}$	$I_F = 50 \text{ mA}$		$\Delta\lambda$		17		nm
Angle of half intensity	$I_F = 50 \text{ mA}$		ϕ		± 9		deg
Forward voltage	$I_F = 50 \text{ mA}$		V_F		2.1	2.7	V
Reverse voltage	$I_R = 10 \mu\text{A}$		V_R	5			V
Temperature coefficient of V_F	$I_F = 50 \text{ mA}$		TC_{V_F}		-2.5		mV/K
Temperature coefficient of λ_d	$I_F = 50 \text{ mA}$		TC_{λ_d}		0.08		nm/K

Note:

1) $T_{amb} = 25 \text{ }^\circ\text{C}$ unless otherwise specified2) In one Packing Unit $I_{Vmax}/I_{Vmin} \leq 2.0$

OPTICAL AND ELECTRICAL CHARACTERISTICS¹⁾, TLCY5100, TLCY5101, YELLOW							
PARAMETER	TEST CONDITION	PART	SYMBOL	MIN	TYP.	MAX	UNIT
Luminous intensity ²⁾	$I_F = 50 \text{ mA}$	TLCY5100	I_V	3200	7500		mcd
		TLCY5101	I_V	5750		20000	mcd
Dominant wavelength	$I_F = 50 \text{ mA}$		λ_d	585	590	597	nm
Peak wavelength	$I_F = 50 \text{ mA}$		λ_p		593		nm
Spectral bandwidth at 50 % $I_{rel \text{ max}}$	$I_F = 50 \text{ mA}$		$\Delta\lambda$		17		nm
Angle of half intensity	$I_F = 50 \text{ mA}$		ϕ		± 9		deg
Forward voltage	$I_F = 50 \text{ mA}$		V_F		2.1	2.7	V
Reverse voltage	$I_R = 10 \mu\text{A}$		V_R	5			V
Temperature coefficient of V_F	$I_F = 50 \text{ mA}$		TC_{V_F}		-3.5		mV/K
Temperature coefficient of λ_d	$I_F = 50 \text{ mA}$		TC_{λ_d}		0.1		nm/K

Note:

1) $T_{amb} = 25 \text{ }^\circ\text{C}$ unless otherwise specified2) In one Packing Unit $I_{Vmax}/I_{Vmin} \leq 2.0$

OPTICAL AND ELECTRICAL CHARACTERISTICS¹⁾, TLCYG5100, YELLOW GREEN							
PARAMETER	TEST CONDITION	PART	SYMBOL	MIN	TYP.	MAX	UNIT
Luminous intensity ²⁾	$I_F = 50 \text{ mA}$	TLCYG5100	I_V	1350	3500		mcd
Dominant wavelength	$I_F = 50 \text{ mA}$		λ_d	565	572	576	nm
Peak wavelength	$I_F = 50 \text{ mA}$		λ_p		574		nm
Spectral bandwidth at 50 % $I_{rel \text{ max}}$	$I_F = 50 \text{ mA}$		$\Delta\lambda$		15		nm
Angle of half intensity	$I_F = 50 \text{ mA}$		ϕ		± 9		deg
Forward voltage	$I_F = 50 \text{ mA}$		V_F		2.2	2.7	V
Reverse voltage	$I_R = 10 \mu\text{A}$		V_R	5			V
Temperature coefficient of V_F	$I_F = 50 \text{ mA}$		TC_{V_F}		-4.5		mV/K
Temperature coefficient of λ_d	$I_F = 50 \text{ mA}$		TC_{λ_d}		0.1		nm/K

Note:

1) $T_{amb} = 25 \text{ }^\circ\text{C}$ unless otherwise specified2) In one Packing Unit $I_{Vmax}/I_{Vmin} \leq 2.0$

OPTICAL AND ELECTRICAL CHARACTERISTICS¹⁾, TLCPG5100, PURE GREEN							
PARAMETER	TEST CONDITION	PART	SYMBOL	MIN	TYP.	MAX	UNIT
Luminous intensity ²⁾	$I_F = 50 \text{ mA}$	TLCPG5100	I_V	430	1250		mcd
Dominant wavelength	$I_F = 50 \text{ mA}$		λ_d	555	562	567	nm
Peak wavelength	$I_F = 50 \text{ mA}$		λ_p		563		nm
Spectral bandwidth at 50 % $I_{rel \text{ max}}$	$I_F = 50 \text{ mA}$		$\Delta\lambda$		20		nm
Angle of half intensity	$I_F = 50 \text{ mA}$		φ		± 9		deg
Forward voltage	$I_F = 50 \text{ mA}$		V_F		2.2	2.7	V
Reverse voltage	$I_R = 10 \mu\text{A}$		V_R	5			V
Temperature coefficient of V_F	$I_F = 50 \text{ mA}$		TC_{V_F}		-3.5		mV/K
Temperature coefficient of λ_d	$I_F = 50 \text{ mA}$		TC_{λ_d}		0.1		nm/K

Note:

1) $T_{amb} = 25 \text{ }^\circ\text{C}$ unless otherwise specified

2) In one Packing Unit $I_{Vmax}/I_{Vmin} \leq 2.0$

LUMINOUS INTENSITY CLASSIFICATION		
GROUP	LUMINOUS INTENSITY (MCD)	
STANDARD	MIN	MAX
BB	430	860
CC	575	1150
DD	750	1500
EE	1000	2000
FF	1350	2700
GG	1800	3600
HH	2400	4800
II	3200	6400
KK	4300	8600
LL	5750	11 500
MM	7500	15 000
NN	10 000	20 000
PP	13 500	27 000
QQ	18 000	36 000
RR	24 000	48 000
SS	32 000	64 000
TT	43 000	86 000
UU	57 500	115 000

Note:

Luminous intensity is tested at a current pulse duration of 25 ms and an accuracy of $\pm 11 \%$.

The above type numbers represent the order groups which include only a few brightness groups. Only one group will be shipped on each bag (there will be no mixing of two groups on each bag).

In order to ensure availability, single brightness groups will not be orderable.

In a similar manner for colors where wavelength groups are measured and binned, single wavelength groups will be shipped in any one bag.

In order to ensure availability, single wavelength groups will not be orderable.

COLOR CLASSIFICATION										
GROUP	DOM. WAVELENGTH (NM)									
	RED		SOFT ORANGE		YELLOW		YELLOW GREEN		PURE GREEN	
	MIN.	MAX.	MIN.	MAX.	MIN.	MAX.	MIN.	MAX.	MIN.	MAX.
0					585	588			555	559
1	611	618			587	591			558	561
2	614	622	600	603	589	594			560	563
3			602	605	592	597			562	565
4			604	607					564	567
5			606	609			565	570		
6			608	611			567	572		
7							569	574		
8							571	576		

Note:

Wavelengths are tested at a current pulse duration of 25 ms and an accuracy of ± 1 nm.

TYPICAL CHARACTERISTICS

$T_{amb} = 25$ °C unless otherwise specified

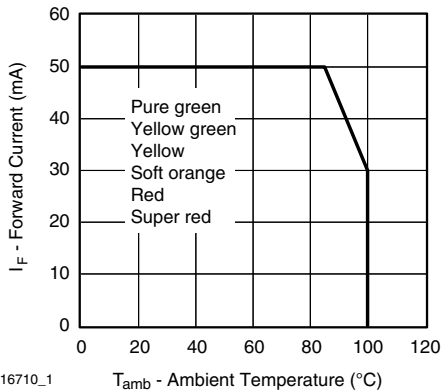

Figure 1. Forward Current vs. Ambient Temperature

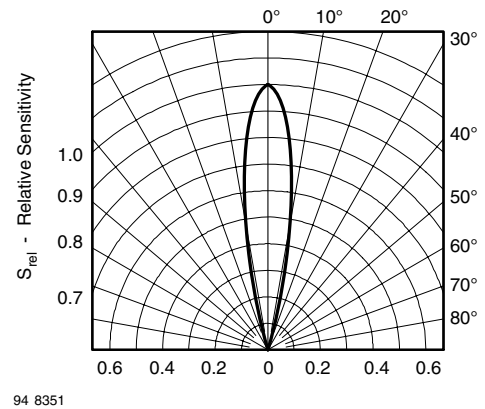

Figure 3. Relative Radiant Sensitivity vs. Angular Displacement

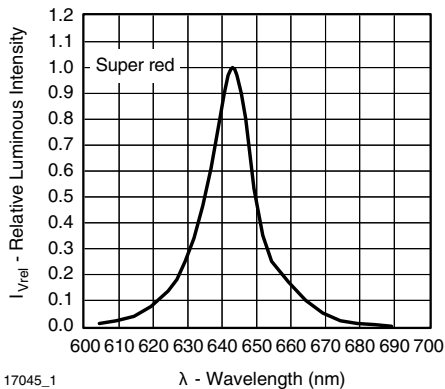

Figure 2. Relative Intensity vs. Wavelength

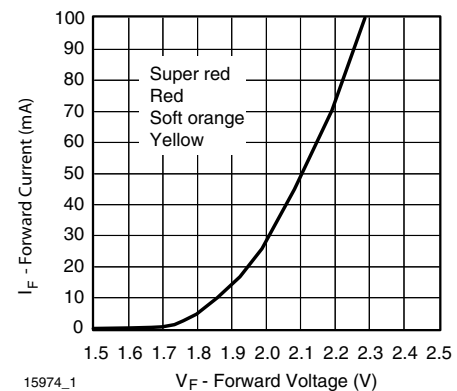

Figure 4. Forward Current vs. Forward Voltage

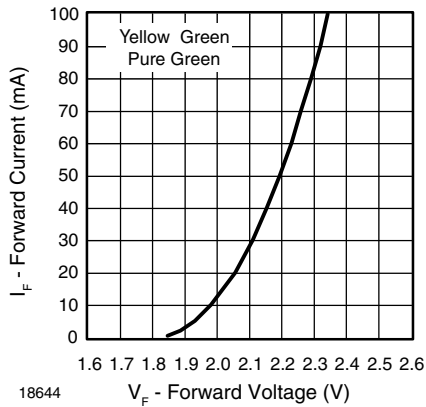

Figure 5. Forward Current vs. Forward Voltage

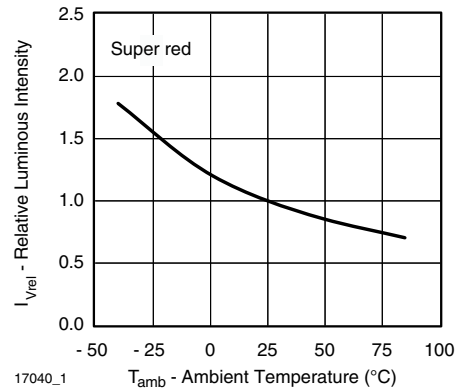

Figure 8. Relative Luminous Intensity vs. Ambient Temperature

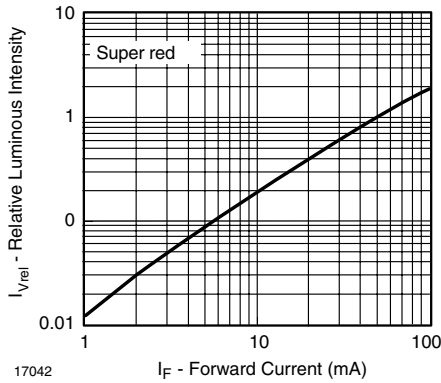

Figure 6. Relative Luminous Flux vs. Forward Current

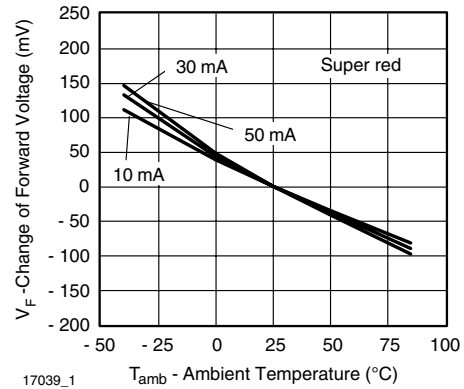

Figure 9. Change of Forward Voltage vs. Ambient Temperature

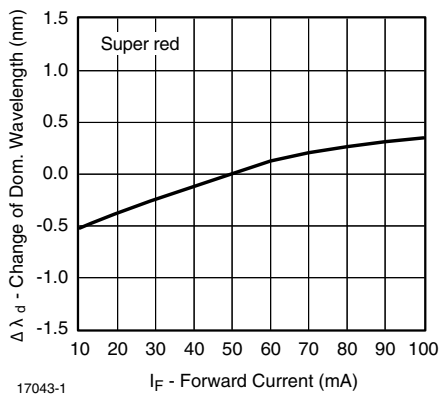

Figure 7. Change of Dominant Wavelength vs. Ambient Temperature

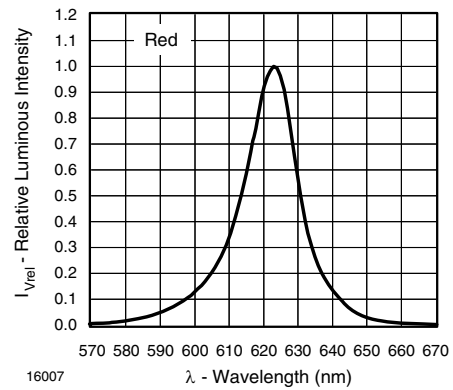

Figure 10. Relative Intensity vs. Wavelength

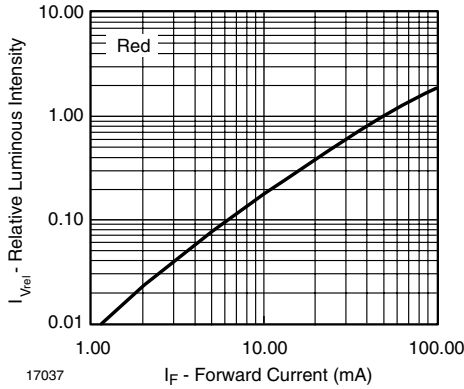

Figure 11. Relative Luminous Flux vs. Forward Current

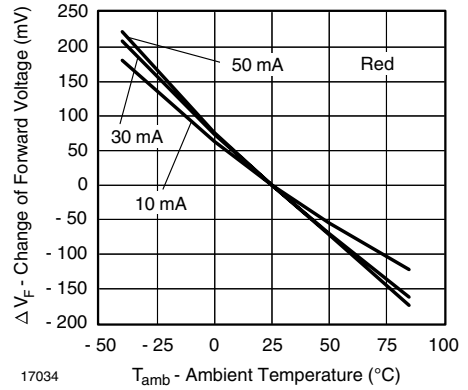

Figure 14. Change of Forward Voltage vs. Ambient Temperature

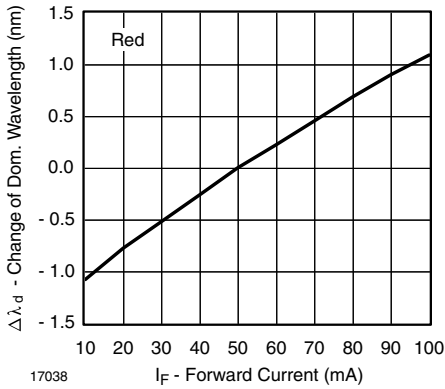

Figure 12. Changes of Dominant Wavelength vs. Forward Current

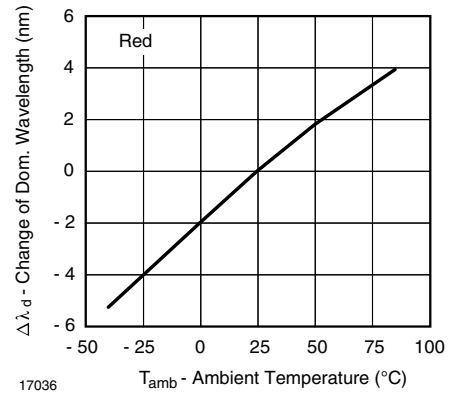

Figure 15. Change of Dominant Wavelength vs. Ambient Temperature

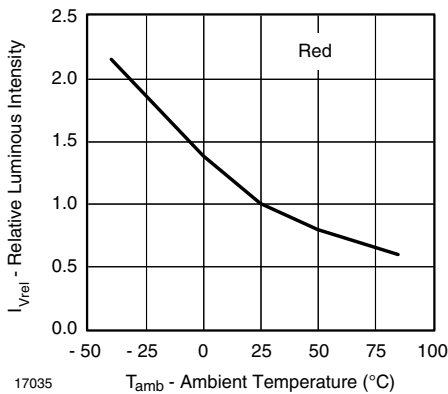

Figure 13. Relative Luminous Intensity vs. Ambient Temperature

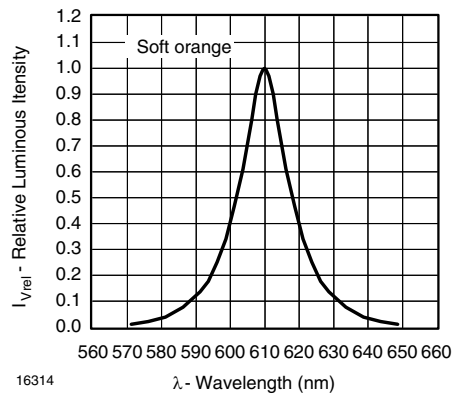

Figure 16. Relative Intensity vs. Wavelength

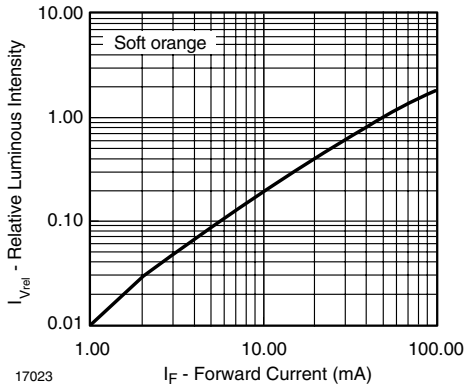

Figure 17. Relative Luminous Flux vs. Forward Current

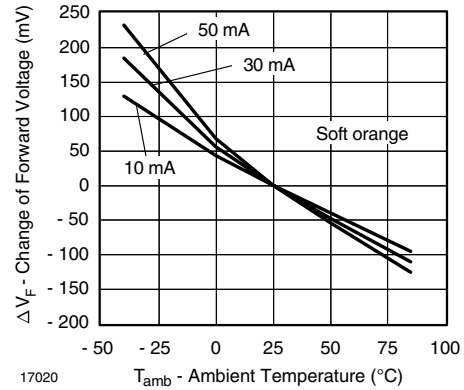

Figure 20. Change of Forward Voltage vs. Ambient Temperature

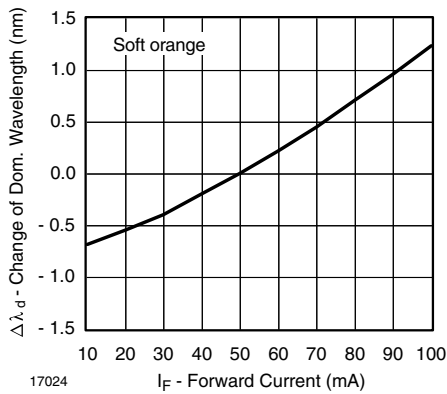

Figure 18. Change of Dominant Wavelength vs. Forward Current

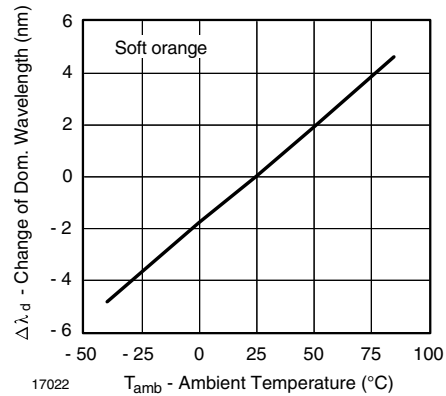

Figure 21. Change of Dominant Wavelength vs. Ambient Temperature

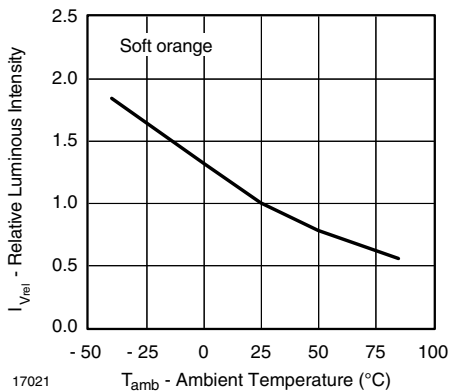

Figure 19. Relative Luminous Intensity vs. Ambient Temperature

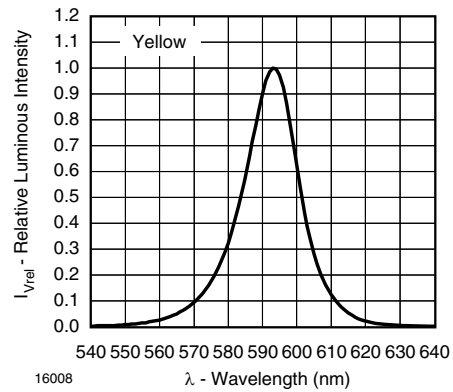

Figure 22. Relative Intensity vs. Wavelength

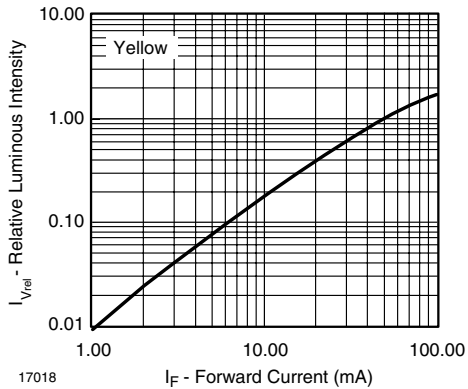

Figure 23. Relative Luminous Flux vs. Forward Current

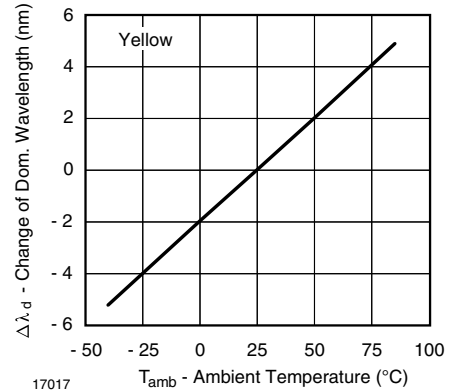

Figure 26. Change of Dominant Wavelength vs. Ambient Temperature

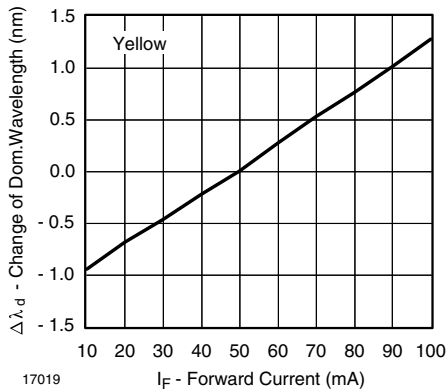

Figure 24. Change of Dominant Wavelength vs. Forward Current

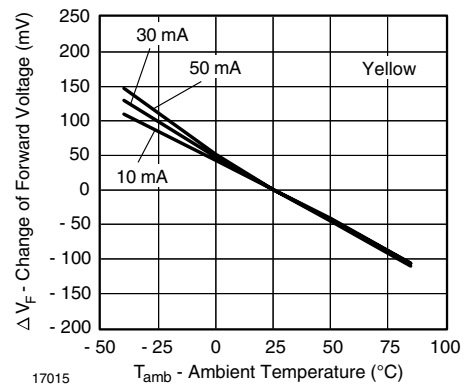

Figure 27. Change of Forward Voltage vs. Ambient Temperature

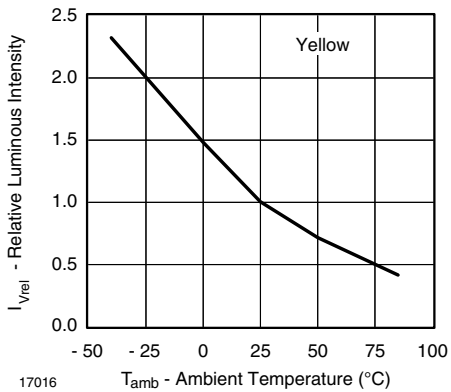

Figure 25. Relative Luminous Intensity vs. Ambient Temperature

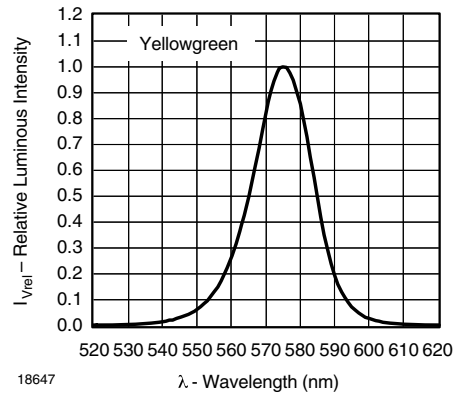

Figure 28. Relative Intensity vs. Wavelength

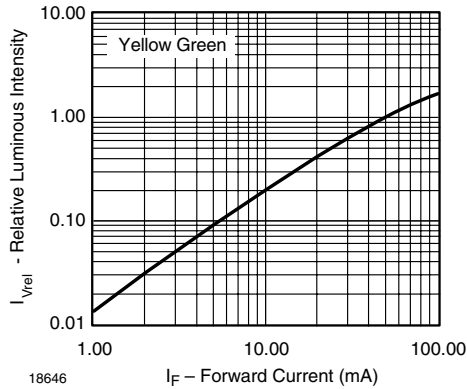

Figure 29. Relative Luminous Flux vs. Forward Current

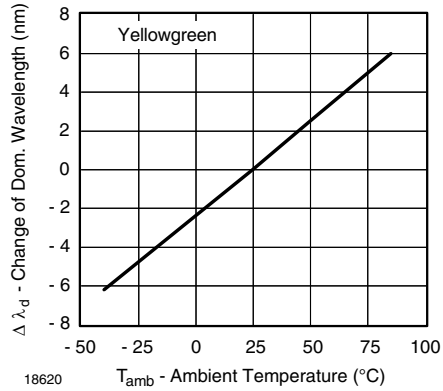

Figure 32. Change of Dominant Wavelength vs. Ambient Temperature

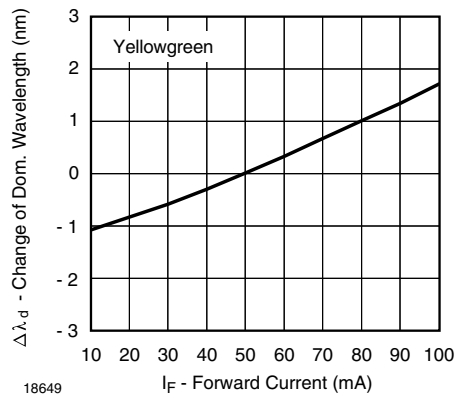

Figure 30. Change of Dominant Wavelength vs. Forward Current

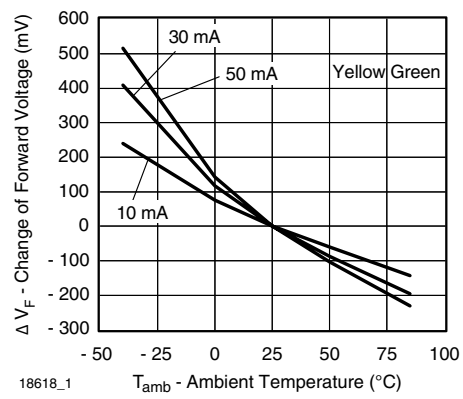

Figure 33. Change of Forward Voltage vs. Ambient Temperature

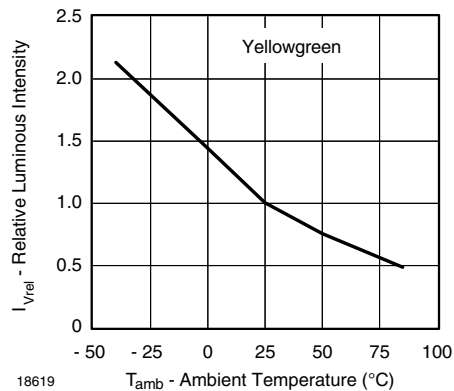

Figure 31. Relative Luminous Intensity vs. Ambient Temperature

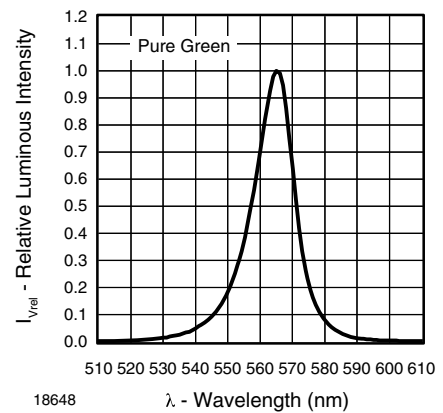

Figure 34. Relative Intensity vs. Wavelength

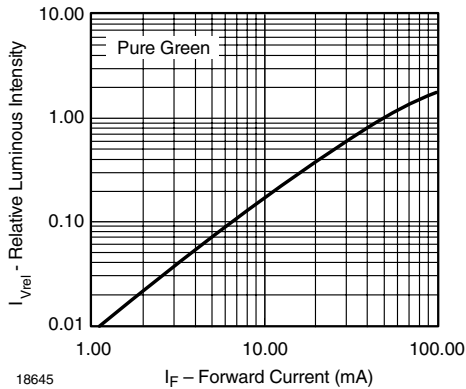

Figure 35. Relative Luminous Flux vs. Forward Current

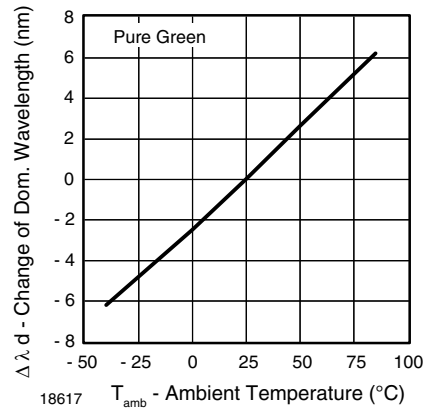

Figure 38. Change of Dominant Wavelength vs. Ambient Temperature

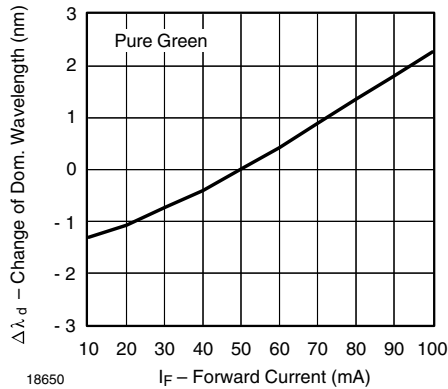

Figure 36. Change of Dominant Wavelength vs. Forward Current

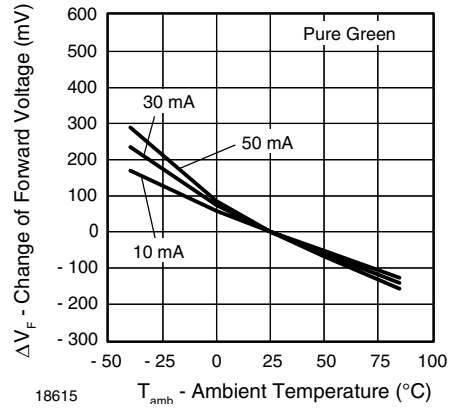

Figure 39. Change of Forward Voltage vs. Ambient Temperature

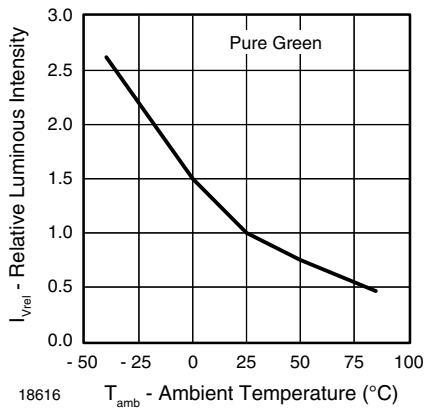
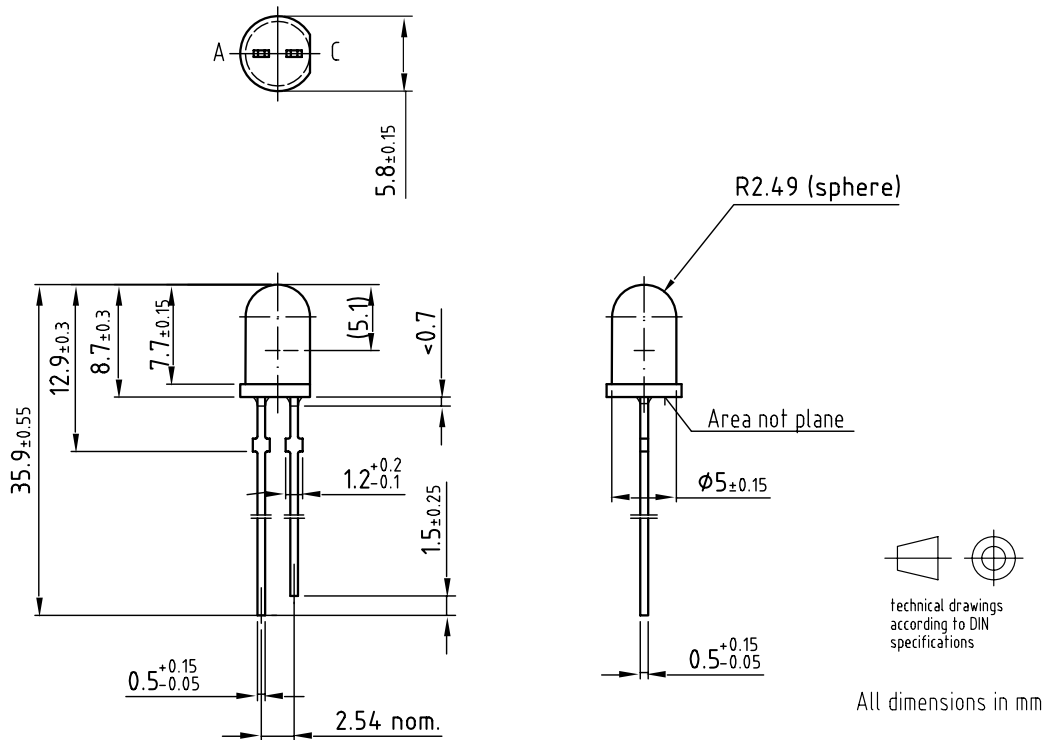

Figure 37. Relative Luminous Intensity vs. Ambient Temperature

PACKAGE DIMENSIONS IN MM



Drawing-No.: 6.544-5258.04-4
Issue: 6; 04.07.03

9612121



OZONE DEPLETING SUBSTANCES POLICY STATEMENT

It is the policy of Vishay Semiconductor GmbH to

1. Meet all present and future national and international statutory requirements.
2. Regularly and continuously improve the performance of our products, processes, distribution and operating systems with respect to their impact on the health and safety of our employees and the public, as well as their impact on the environment.

It is particular concern to control or eliminate releases of those substances into the atmosphere which are known as ozone depleting substances (ODSs).

The Montreal Protocol (1987) and its London Amendments (1990) intend to severely restrict the use of ODSs and forbid their use within the next ten years. Various national and international initiatives are pressing for an earlier ban on these substances.

Vishay Semiconductor GmbH has been able to use its policy of continuous improvements to eliminate the use of ODSs listed in the following documents.

1. Annex A, B and list of transitional substances of the Montreal Protocol and the London Amendments respectively
2. Class I and II ozone depleting substances in the Clean Air Act Amendments of 1990 by the Environmental Protection Agency (EPA) in the USA
3. Council Decision 88/540/EEC and 91/690/EEC Annex A, B and C (transitional substances) respectively.

Vishay Semiconductor GmbH can certify that our semiconductors are not manufactured with ozone depleting substances and do not contain such substances.

We reserve the right to make changes to improve technical design and may do so without further notice.

Parameters can vary in different applications. All operating parameters must be validated for each customer application by the customer. Should the buyer use Vishay Semiconductors products for any unintended or unauthorized application, the buyer shall indemnify Vishay Semiconductors against all claims, costs, damages, and expenses, arising out of, directly or indirectly, any claim of personal damage, injury or death associated with such unintended or unauthorized use.

Vishay Semiconductor GmbH, P.O.B. 3535, D-74025 Heilbronn, Germany



Notice

Specifications of the products displayed herein are subject to change without notice. Vishay Intertechnology, Inc., or anyone on its behalf, assumes no responsibility or liability for any errors or inaccuracies.

Information contained herein is intended to provide a product description only. No license, express or implied, by estoppel or otherwise, to any intellectual property rights is granted by this document. Except as provided in Vishay's terms and conditions of sale for such products, Vishay assumes no liability whatsoever, and disclaims any express or implied warranty, relating to sale and/or use of Vishay products including liability or warranties relating to fitness for a particular purpose, merchantability, or infringement of any patent, copyright, or other intellectual property right.

The products shown herein are not designed for use in medical, life-saving, or life-sustaining applications. Customers using or selling these products for use in such applications do so at their own risk and agree to fully indemnify Vishay for any damages resulting from such improper use or sale.