

High Brightness LED, Ø 5 mm Untinted Non-Diffused

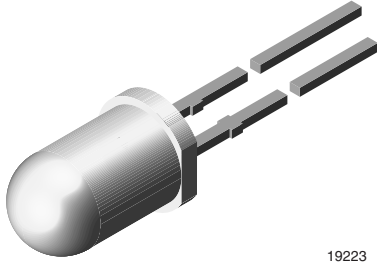

19223

DESCRIPTION

The VLC.58.. series is a clear, non diffused 5 mm LED for high end applications where supreme luminous intensity and a very small emission angle is required.

These lamps with clear untinted plastic case utilize the highly developed ultrabright AllnGaP technology.

The very small viewing angle of these devices provide a very high luminous intensity.

PRODUCT GROUP AND PACKAGE DATA

- Product group: LED
- Package: 5 mm
- Product series: power
- Angle of half intensity: $\pm 4^\circ$

FEATURES

- Untinted non diffused lens
- Utilizing ultrabright AllnGaP technology
- Very high luminous intensity
- Very small emission angle
- High operating temperature: T_j (chip junction temperature) up to 125 °C for AllnGaP devices
- Luminous intensity and color categorized for each packing unit
- ESD-withstand voltage: up to 2 kV according to JESD22-A114-B
- AEC-Q101 qualified
- Compliant to RoHS directive 2002/95/EC and in accordance to WEEE 2002/96/EC
- Find out more about Vishay's Automotive Grade Product requirements at: www.vishay.com/applications



APPLICATIONS

- Interior and exterior lighting
- Outdoor LED panels, displays
- Instrumentation and front panel indicators
- Central high mounted stop lights (CHMSL) for motor vehicles
- Replaces incandescent lamps
- Traffic signals and signs
- Light guide design

PARTS TABLE

PART	COLOR, LUMINOUS INTENSITY	TECHNOLOGY
VLCS5830	Red, $I_V > 24\,000$ mcd (typ. 65 000 mcd)	AllnGaP on Si

ABSOLUTE MAXIMUM RATINGS ($T_{amb} = 25\text{ }^\circ\text{C}$, unless otherwise specified) VLCS5830

PARAMETER	TEST CONDITION	SYMBOL	VALUE	UNIT
Reverse voltage ¹⁾		V_R	5	V
DC Forward current	$T_{amb} \leq 85^\circ\text{C}$	I_F	50	mA
Surge forward current	$t_p \leq 10\ \mu\text{s}$	I_{FSM}	0.1	A
Power dissipation		P_V	150	mW
Junction temperature		T_j	125	$^\circ\text{C}$
Operating temperature range		T_{amb}	- 40 to + 100	$^\circ\text{C}$
Storage temperature range		T_{stg}	- 40 to + 100	$^\circ\text{C}$
Soldering temperature	$t \leq 5\ \text{s}$, 2 mm from body	T_{sd}	260	$^\circ\text{C}$
Thermal resistance junction/ambient		R_{thJA}	300	K/W

Note:

1) Driving the LED in reverse direction is suitable for short term application

** Please see document "Vishay Material Category Policy": www.vishay.com/doc?99902

OPTICAL AND ELECTRICAL CHARACTERISTICS (T _{amb} = 25 °C, unless otherwise specified)							
VLCS5830, RED							
PARAMETER	TEST CONDITION	PART	SYMBOL	MIN.	TYP.	MAX.	UNIT
Luminous intensity ¹⁾	I _F = 50 mA	VLCS5830	I _V	24 000	65 000		mcd
Dominant wavelength ²⁾	I _F = 50 mA		λ _d	620	624	630	nm
Peak wavelength	I _F = 50 mA		λ _p		631		nm
Spectral bandwidth at 50 % I _{rel max.}	I _F = 50 mA		Δλ		18		nm
Angle of half intensity	I _F = 50 mA		φ		± 4		deg
Forward voltage ³⁾	I _F = 50 mA		V _F		2.2	3.0	V
Reverse voltage	I _R = 10 μA		V _R	5			V
Temperature coefficient of V _F	I _F = 50 mA		TC _{V_F}		- 2		mV/K
Temperature coefficient of λ _d	I _F = 50 mA		TCλ _d		0.05		nm/K

Note:

- ¹⁾ In one packing unit I_{Vmax}/I_{Vmin} ≤ 2.0
- ²⁾ Wavelengths are tested at a current pulse duration of 25 ms and a tolerance of ± 1 nm
- ³⁾ Forward voltages are tested at a current pulse duration of 1 ms and a tolerance of ± 0.05 V

LUMINOUS INTENSITY CLASSIFICATION		
GROUP	LIGHT INTENSITY (mcd)	
	MIN.	MAX.
RR	24 000	48 000
SS	32 000	64 000
TT	43 000	86 000
UU	57 500	115 000
VV	72 000	150 000
WW	100 000	200 000

Note:

Luminous intensity is tested at a current pulse duration of 25 ms and an accuracy of ± 11 %.
 The above type numbers represent the order groups which include only a few brightness groups. Only one group will be shipped on each reel (there will be no mixing of two groups on each reel).
 In order to ensure availability, single brightness groups will not be orderable.
 In a similar manner for colors where wavelength groups are measured and binned, single wavelength groups will be shipped in any one reel. In order to ensure availability, single wavelength groups will not be orderable.

TYPICAL CHARACTERISTICS (T_{amb} = 25 °C, unless otherwise specified)

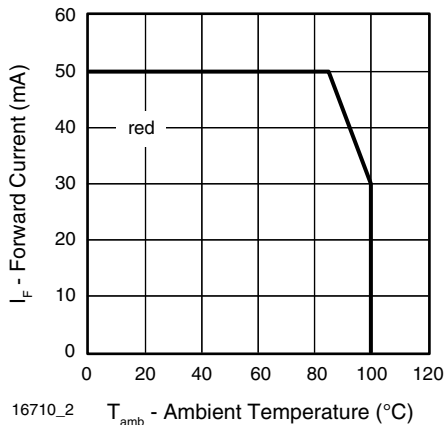

Figure 1. Max. Permissible Forward Current vs. Ambient Temperature

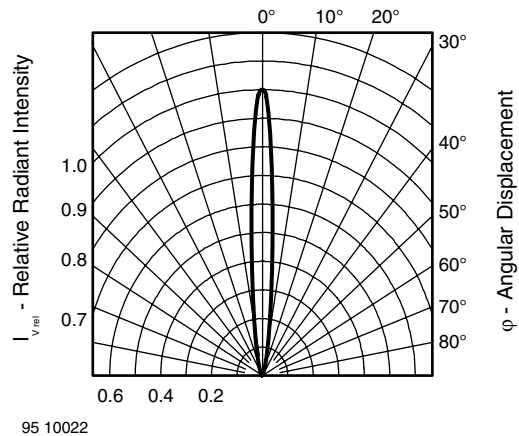

Figure 2. Relative Intensity vs. Angular Displacement

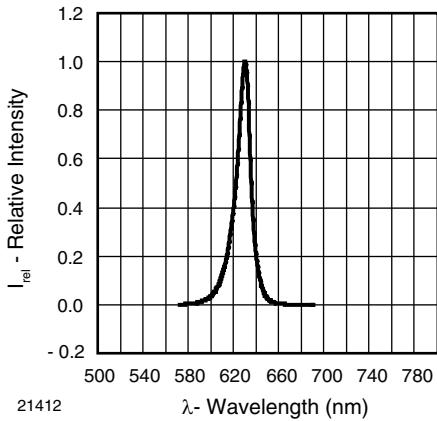

Figure 3. Relative Intensity vs. Wavelength

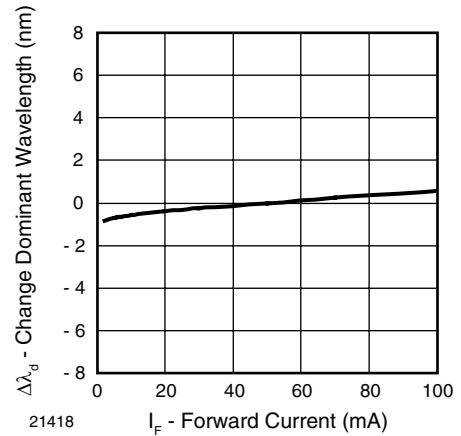

Figure 6. Change of Dominant Wavelength vs. Forward Current

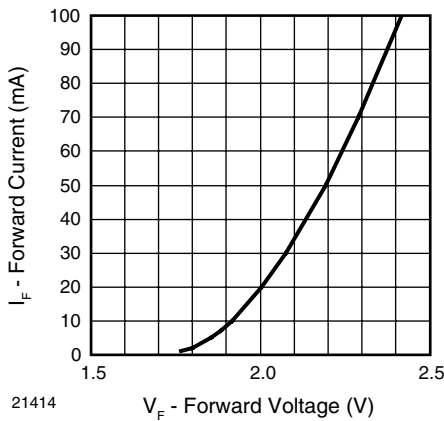

Figure 4. Forward Current vs. Forward Voltage

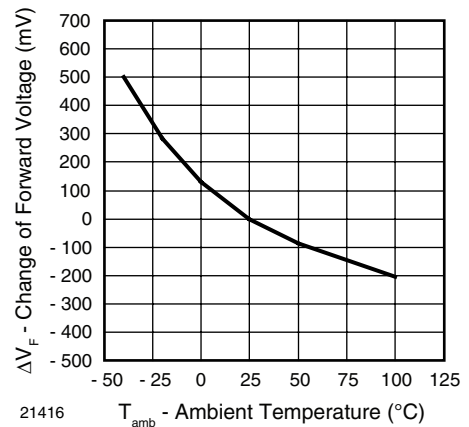

Figure 7. Change of Forward Voltage vs. Ambient Temperature

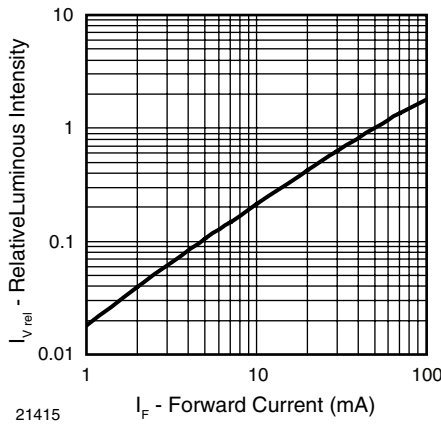

Figure 5. Relative Luminous Intensity vs. Forward Current

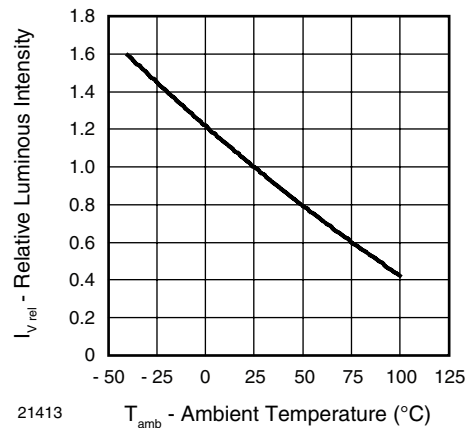
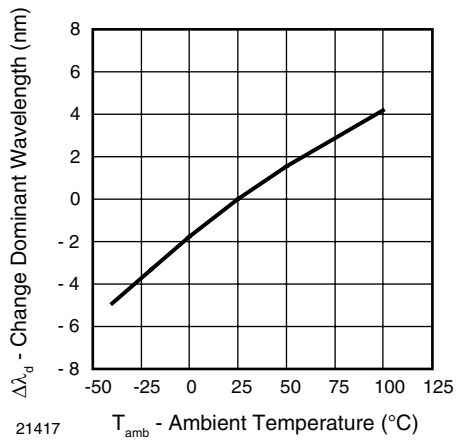

Figure 8. Relative Luminous Intensity vs. Ambient Temperature



21417 T_{amb} - Ambient Temperature (°C)

Figure 9. Change of Dominant Wavelength vs. Ambient Temperature

PACKAGE DIMENSIONS in millimeters

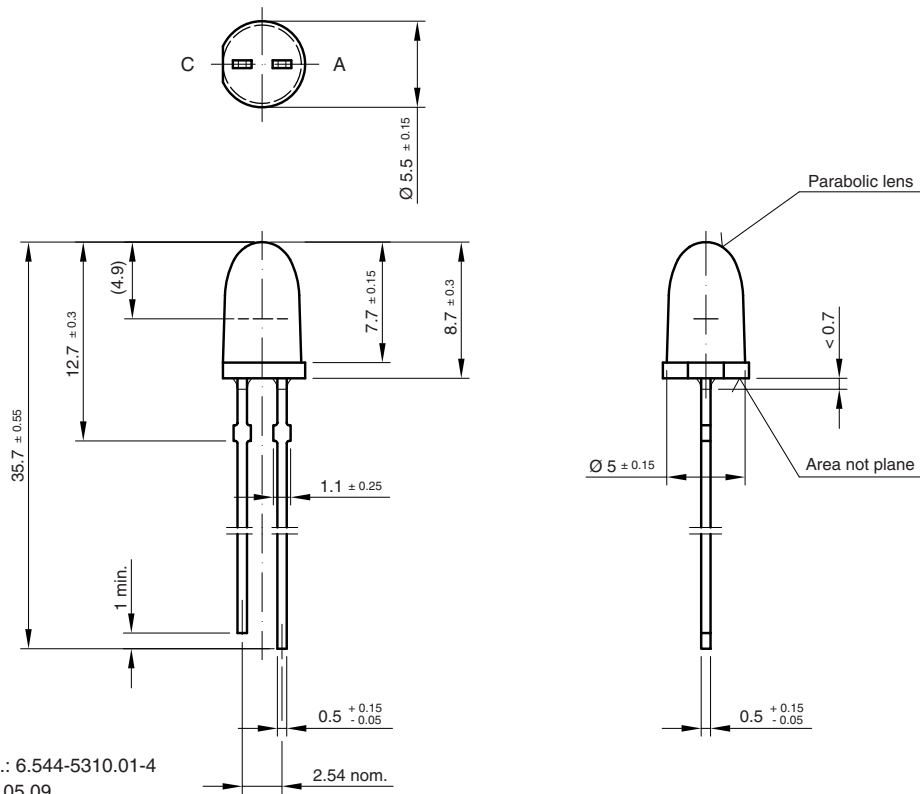

Drawing-No.: 6.544-5310.01-4
 Issue: 4; 19.05.09
 95 11476

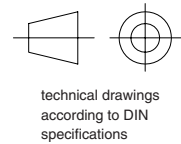



Disclaimer

ALL PRODUCT, PRODUCT SPECIFICATIONS AND DATA ARE SUBJECT TO CHANGE WITHOUT NOTICE TO IMPROVE RELIABILITY, FUNCTION OR DESIGN OR OTHERWISE.

Vishay Intertechnology, Inc., its affiliates, agents, and employees, and all persons acting on its or their behalf (collectively, "Vishay"), disclaim any and all liability for any errors, inaccuracies or incompleteness contained in any datasheet or in any other disclosure relating to any product.

Vishay makes no warranty, representation or guarantee regarding the suitability of the products for any particular purpose or the continuing production of any product. To the maximum extent permitted by applicable law, Vishay disclaims (i) any and all liability arising out of the application or use of any product, (ii) any and all liability, including without limitation special, consequential or incidental damages, and (iii) any and all implied warranties, including warranties of fitness for particular purpose, non-infringement and merchantability.

Statements regarding the suitability of products for certain types of applications are based on Vishay's knowledge of typical requirements that are often placed on Vishay products in generic applications. Such statements are not binding statements about the suitability of products for a particular application. It is the customer's responsibility to validate that a particular product with the properties described in the product specification is suitable for use in a particular application. Parameters provided in datasheets and/or specifications may vary in different applications and performance may vary over time. All operating parameters, including typical parameters, must be validated for each customer application by the customer's technical experts. Product specifications do not expand or otherwise modify Vishay's terms and conditions of purchase, including but not limited to the warranty expressed therein.

Except as expressly indicated in writing, Vishay products are not designed for use in medical, life-saving, or life-sustaining applications or for any other application in which the failure of the Vishay product could result in personal injury or death. Customers using or selling Vishay products not expressly indicated for use in such applications do so at their own risk and agree to fully indemnify and hold Vishay and its distributors harmless from and against any and all claims, liabilities, expenses and damages arising or resulting in connection with such use or sale, including attorneys fees, even if such claim alleges that Vishay or its distributor was negligent regarding the design or manufacture of the part. Please contact authorized Vishay personnel to obtain written terms and conditions regarding products designed for such applications.

No license, express or implied, by estoppel or otherwise, to any intellectual property rights is granted by this document or by any conduct of Vishay. Product names and markings noted herein may be trademarks of their respective owners.