

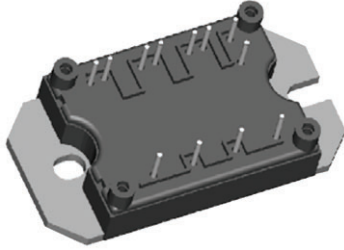

“Half Bridge” IGBT MTP (Ultrafast NPT IGBT), 80 A

MTP

PRIMARY CHARACTERISTICS	
V_{CES}	1200 V
$V_{CE(on)}$ typical at $V_{GE} = 15$ V	3.36 V
I_C at $T_C = 25$ °C	80 A
Speed	8 kHz to 30 kHz
Package	MTP
Circuit configuration	Half bridge

FEATURES

- Ultrafast non punch through (NPT) technology
- Positive $V_{CE(on)}$ temperature coefficient
- 10 μ s short circuit capability
- Square RBSOA
- HEXFRED® antiparallel diodes with ultrasoft reverse recovery and low V_F
- Al_2O_3 DBC
- Very low stray inductance design for high speed operation
- UL approved file E78996 
- Designed and qualified for industrial level
- Material categorization: for definitions of compliance please see www.vishay.com/doc?999912

RoHS*
Available

Note

* This datasheet provides information about parts that are RoHS-compliant and / or parts that are non RoHS-compliant. For example, parts with lead (Pb) terminations are not RoHS-compliant. Please see the information / tables in this datasheet for details

BENEFITS

- Optimized for welding, UPS and SMPS applications
- Rugged with ultrafast performance
- Benchmark efficiency above 20 kHz
- Outstanding ZVS and hard switching operation
- Low EMI, requires less snubbing
- Excellent current sharing in parallel operation
- Direct mounting to heatsink
- PCB solderable terminals
- Very low junction to case thermal resistance

ABSOLUTE MAXIMUM RATINGS				
PARAMETER	SYMBOL	TEST CONDITIONS	MAX.	UNITS
Collector to emitter breakdown voltage	V_{CES}		1200	V
Continuous collector current	I_C	$T_C = 25$ °C	80	A
		$T_C = 104$ °C	40	
Pulsed collector current	I_{CM}		160	
Clamped inductive load current	I_{LM}		160	
Diode continuous forward current	I_F	$T_C = 105$ °C	21	
Diode maximum forward current	I_{FM}		160	
Gate to emitter voltage	V_{GE}		± 20	V
RMS isolation voltage	V_{ISOL}	Any terminal to case, $t = 1$ min	2500	
Maximum power dissipation (only IGBT)	P_D	$T_C = 25$ °C	463	W
		$T_C = 100$ °C	185	



ELECTRICAL SPECIFICATIONS ($T_J = 25\text{ }^\circ\text{C}$ unless otherwise specified)						
PARAMETER	SYMBOL	TEST CONDITIONS	MIN.	TYP.	MAX.	UNITS
Collector to emitter breakdown voltage	$V_{(BR)CES}$	$V_{GE} = 0\text{ V}, I_C = 250\text{ }\mu\text{A}$	1200	-	-	V
Temperature coefficient of breakdown voltage	$\Delta V_{(BR)CES}/\Delta T_J$	$V_{GE} = 0\text{ V}, I_C = 3\text{ mA}$ (25 °C to 125 °C)	-	+1.1	-	V/°C
Collector to emitter saturation voltage	$V_{CE(on)}$	$V_{GE} = 15\text{ V}, I_C = 40\text{ A}$	-	3.36	3.59	V
		$V_{GE} = 15\text{ V}, I_C = 80\text{ A}$	-	4.53	4.91	
		$V_{GE} = 15\text{ V}, I_C = 40\text{ A}, T_J = 150\text{ }^\circ\text{C}$	-	3.88	4.10	
		$V_{GE} = 15\text{ V}, I_C = 80\text{ A}, T_J = 150\text{ }^\circ\text{C}$	-	5.35	5.68	
Gate threshold voltage	$V_{GE(th)}$	$V_{CE} = V_{GE}, I_C = 500\text{ }\mu\text{A}$	4	-	6	
Temperature coefficient of threshold voltage	$V_{GE(th)}/\Delta T_J$	$V_{CE} = V_{GE}, I_C = 1\text{ mA}$ (25 °C to 125 °C)	-	-12	-	mV/°C
Transconductance	g_{fe}	$V_{CE} = 50\text{ V}, I_C = 40\text{ A}, PW = 80\text{ }\mu\text{s}$	-	35	-	S
Zero gate voltage collector current	I_{CES}	$V_{GE} = 0\text{ V}, V_{CE} = 1200\text{ V}, T_J = 25\text{ }^\circ\text{C}$	-	-	250	μA
		$V_{GE} = 0\text{ V}, V_{CE} = 1200\text{ V}, T_J = 125\text{ }^\circ\text{C}$	-	0.4	1.0	mA
		$V_{GE} = 0\text{ V}, V_{CE} = 1200\text{ V}, T_J = 150\text{ }^\circ\text{C}$	-	0.2	10	
Gate to emitter leakage current	I_{GES}	$V_{GE} = \pm 20\text{ V}$	-	-	± 250	nA

SWITCHING CHARACTERISTICS ($T_J = 25\text{ }^\circ\text{C}$ unless otherwise specified)						
PARAMETER	SYMBOL	TEST CONDITIONS	MIN.	TYP.	MAX.	UNITS
Total gate charge (turn-on)	Q_g	$I_C = 40\text{ A}$ $V_{CC} = 600\text{ V}$ $V_{GE} = 15\text{ V}$	-	399	599	nC
Gate to emitter charge (turn-on)	Q_{ge}		-	43	65	
Gate to collector charge (turn-on)	Q_{gc}		-	187	281	
Turn-on switching loss	E_{on}	$V_{CC} = 600\text{ V}, I_C = 40\text{ A}, V_{GE} = 15\text{ V},$ $R_g = 5\text{ }\Omega, L = 200\text{ }\mu\text{H}, T_J = 25\text{ }^\circ\text{C},$ energy losses include tail and diode reverse recovery	-	1.14	1.71	mJ
Turn-off switching loss	E_{off}		-	1.35	2.02	
Total switching loss	E_{tot}		-	2.49	3.73	
Turn-on switching loss	E_{on}	$V_{CC} = 600\text{ V}, I_C = 40\text{ A}, V_{GE} = 15\text{ V},$ $R_g = 5\text{ }\Omega, L = 200\text{ }\mu\text{H}, T_J = 125\text{ }^\circ\text{C},$ energy losses include tail and diode reverse recovery	-	1.60	2.40	mJ
Turn-off switching loss	E_{off}		-	1.62	2.43	
Total switching loss	E_{tot}		-	3.22	4.82	
Input capacitance	C_{ies}	$V_{GE} = 0\text{ V}$ $V_{CC} = 30\text{ V}$ $f = 1.0\text{ MHz}$	-	5521	8282	pF
Output capacitance	C_{oes}		-	380	570	
Reverse transfer capacitance	C_{res}		-	171	257	
Reverse bias safe operating area	RBSOA	$T_J = 150\text{ }^\circ\text{C}, I_C = 160\text{ A}$ $V_{CC} = 1000\text{ V}, V_p = 1200\text{ V}$ $R_g = 5\text{ }\Omega, V_{GE} = +15\text{ V to }0\text{ V}$	Fullsquare			
Short circuit safe operating area	SCSOA	$T_J = 150\text{ }^\circ\text{C},$ $V_{CC} = 900\text{ V}, V_p = 1200\text{ V}$ $R_g = 5\text{ }\Omega, V_{GE} = +15\text{ V to }0\text{ V}$	10	-	-	μs

DIODE SPECIFICATIONS ($T_J = 25\text{ }^\circ\text{C}$ unless otherwise specified)						
PARAMETER	SYMBOL	TEST CONDITIONS	MIN.	TYP.	MAX.	UNITS
Diode forward voltage drop	V_{FM}	$I_C = 40\text{ A}$	-	2.98	3.38	V
		$I_C = 80\text{ A}$	-	3.90	4.41	
		$I_C = 40\text{ A}, T_J = 125\text{ }^\circ\text{C}$	-	3.08	3.39	
		$I_C = 80\text{ A}, T_J = 125\text{ }^\circ\text{C}$	-	4.29	4.72	
		$I_C = 40\text{ A}, T_J = 150\text{ }^\circ\text{C}$	-	3.12	3.42	
Reverse recovery energy of the diode	E_{rec}	$V_{GE} = 15\text{ V}, R_g = 5\text{ }\Omega, L = 200\text{ }\mu\text{H}$ $V_{CC} = 600\text{ V}, I_C = 40\text{ A}$ $T_J = 125\text{ }^\circ\text{C}$	-	574	861	μJ
Diode reverse recovery time	t_{rr}		-	120	180	ns
Peak reverse recovery current	I_{rr}		-	43	65	A



THERMAL AND MECHANICAL SPECIFICATIONS						
PARAMETER	SYMBOL	TEST CONDITIONS	MIN.	TYP.	MAX.	UNITS
Operating junction temperature range	T_J		-40	-	150	°C
Storage temperature range	T_{Stg}		-40	-	125	
Junction to case	IGBT		-	-	0.29	°C/W
	Diode					
Case to sink per module	R_{thCS}	Heatsink compound thermal conductivity = 1 W/mK	-	0.06	-	
Clearance ⁽¹⁾		External shortest distance in air between 2 terminals	5.5	-	-	
Creepage ⁽²⁾		Shortest distance along external surface of the insulating material between 2 terminals	8	-	-	
Mounting torque to heatsink		A mounting compound is recommended and the torque should be checked after 3 hours to allow for the spread of the compound. Lubricated threads.	3 ± 10 %			Nm
Weight			66			g

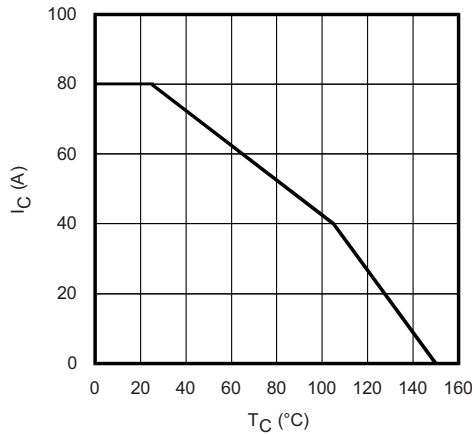

Fig. 1 - Maximum DC Collector Current vs. Case Temperature

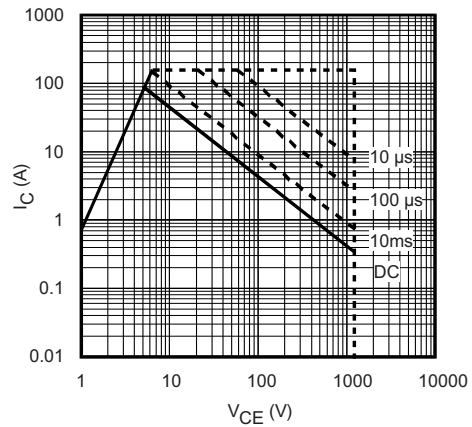

Fig. 3 - Forward SOA
 $T_C = 25$ °C; $T_J \leq 150$ °C

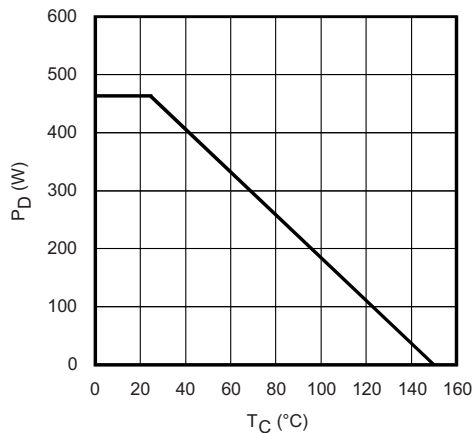

Fig. 2 - Power Dissipation vs. Case Temperature

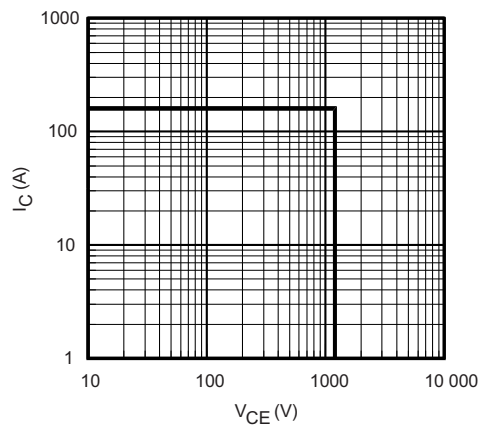

Fig. 4 - Reverse BIAS SOA
 $T_J = 150$ °C; $V_{GE} = 15$ V

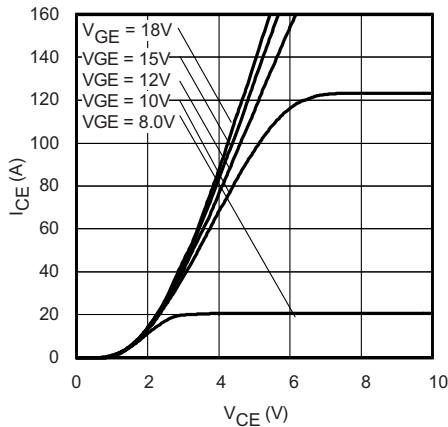

Fig. 5 - Typical IGBT Output Characteristics
 $T_J = -40\text{ }^\circ\text{C}; t_p = 80\text{ }\mu\text{s}$

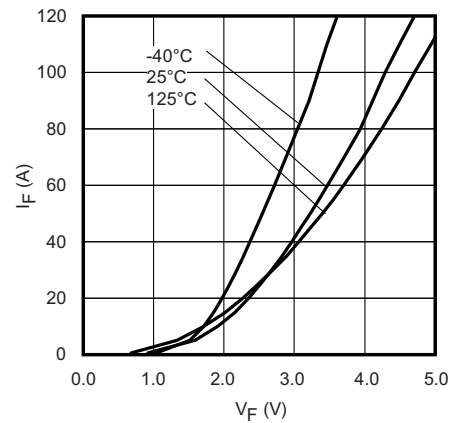

Fig. 8 - Typical Diode Forward Characteristics
 $t_p = 80\text{ }\mu\text{s}$

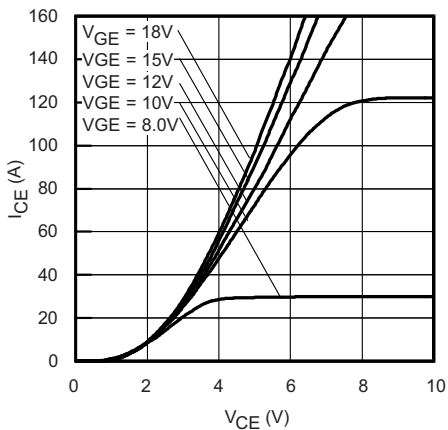

Fig. 6 - Typical IGBT Output Characteristics
 $T_J = 25\text{ }^\circ\text{C}; t_p = 80\text{ }\mu\text{s}$

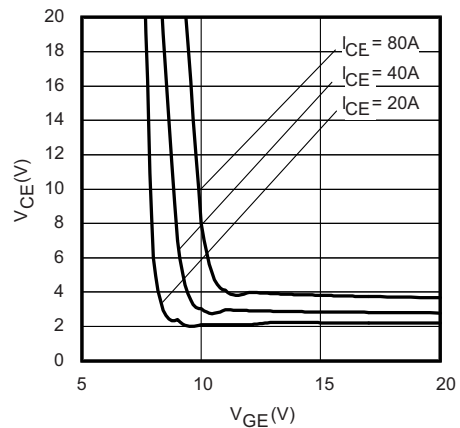

Fig. 9 - Typical V_{CE} vs. V_{GE}
 $T_J = -40\text{ }^\circ\text{C}$

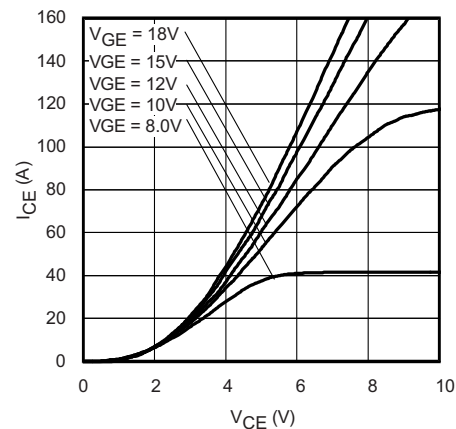

Fig. 7 - Typical IGBT Output Characteristics
 $T_J = 125\text{ }^\circ\text{C}; t_p = 80\text{ }\mu\text{s}$

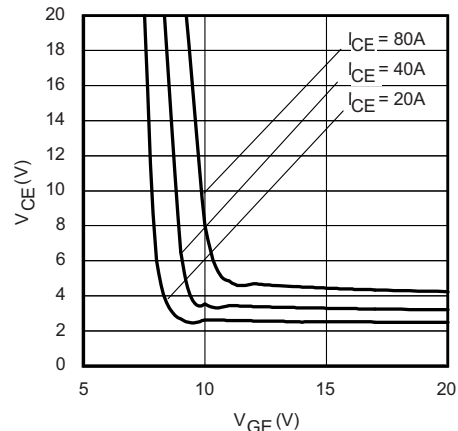

Fig. 10 - Typical V_{CE} vs. V_{GE}
 $T_J = 25\text{ }^\circ\text{C}$

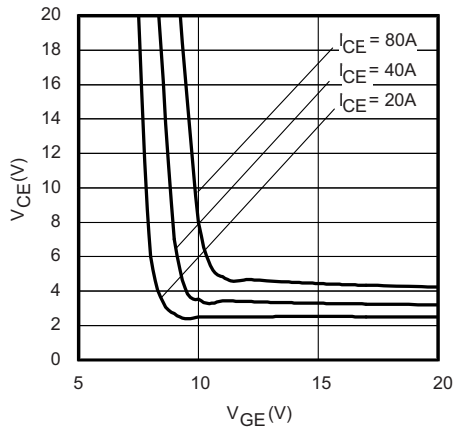

Fig. 11 - Typical V_{CE} vs. V_{GE}
 $T_J = 125^\circ\text{C}$

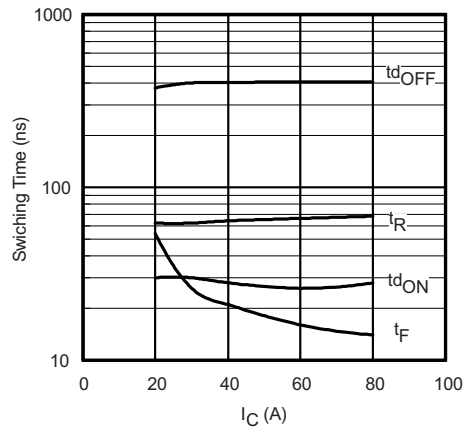

Fig. 14 - Typical Switching Time vs. I_C
 $T_J = 125^\circ\text{C}$; $L = 250\ \mu\text{H}$; $V_{CE} = 400\ \text{V}$
 $R_g = 5\ \Omega$; $V_{GE} = 15\ \text{V}$

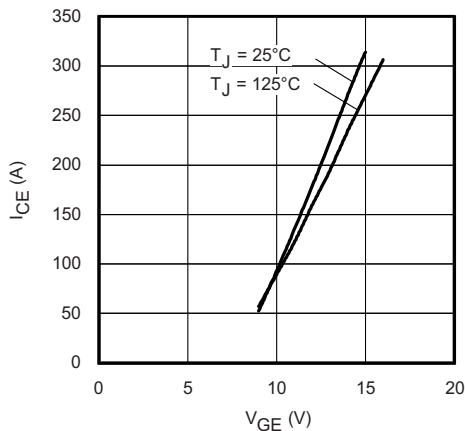

Fig. 12 - Typical Transfer Characteristics
 $V_{CE} = 50\ \text{V}$; $t_p = 10\ \mu\text{s}$

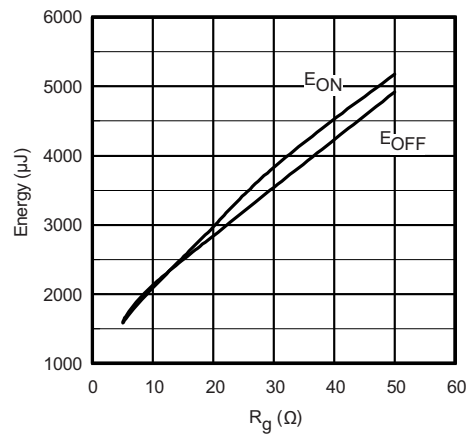

Fig. 15 - Typical Energy Loss vs. R_g
 $T_J = 150^\circ\text{C}$; $L = 250\ \mu\text{H}$; $V_{CE} = 600\ \text{V}$
 $I_{CE} = 40\ \text{A}$; $V_{GE} = 15\ \text{V}$

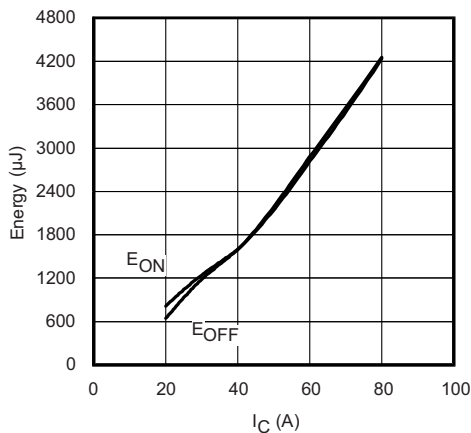

Fig. 13 - Typical Energy Loss vs. I_C
 $T_J = 125^\circ\text{C}$; $L = 250\ \mu\text{H}$; $V_{CE} = 400\ \text{V}$
 $R_g = 5\ \Omega$; $V_{GE} = 15\ \text{V}$

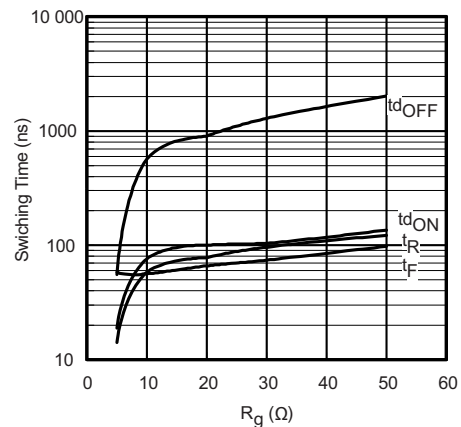

Fig. 16 - Typical Switching Time vs. R_g
 $T_J = 150^\circ\text{C}$; $L = 250\ \mu\text{H}$; $V_{CE} = 600\ \text{V}$
 $I_{CE} = 40\ \text{A}$; $V_{GE} = 15\ \text{V}$

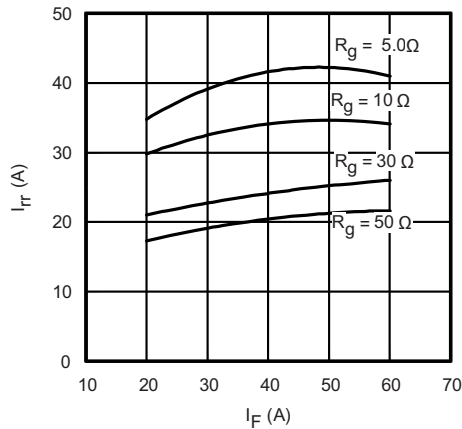

Fig. 17 - Typical Diode I_{rr} vs. I_F
 $T_J = 125\text{ }^\circ\text{C}$

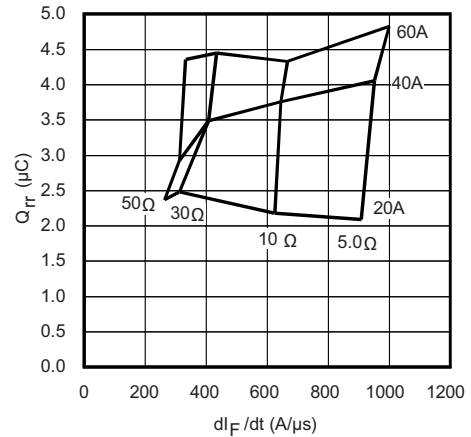

Fig. 20 - Typical Diode Q_{rr} vs. dI_F/dt
 $V_{CC} = 600\text{ V}$; $V_{GE} = 15\text{ V}$; $T_J = 125\text{ }^\circ\text{C}$

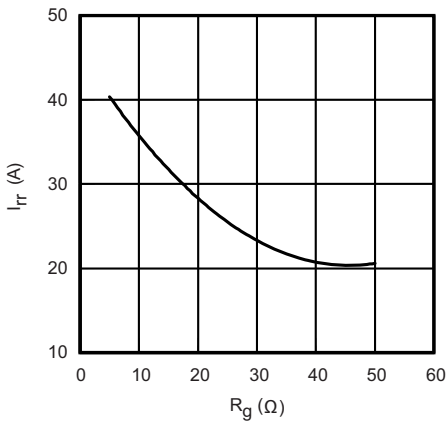

Fig. 18 - Typical Diode I_{rr} vs. R_g
 $T_J = 125\text{ }^\circ\text{C}$; $I_F = 40\text{ A}$

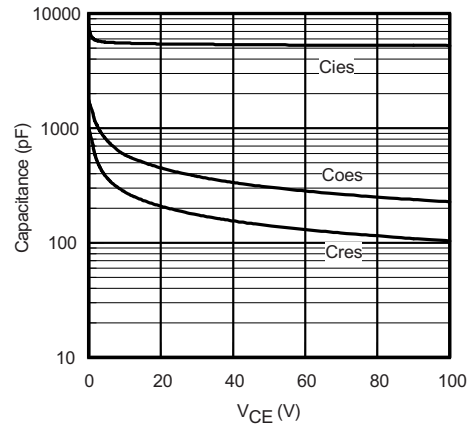

Fig. 21 - Typical Capacitance vs. V_{CE}
 $V_{GE} = 0\text{ V}$; $f = 1\text{ MHz}$

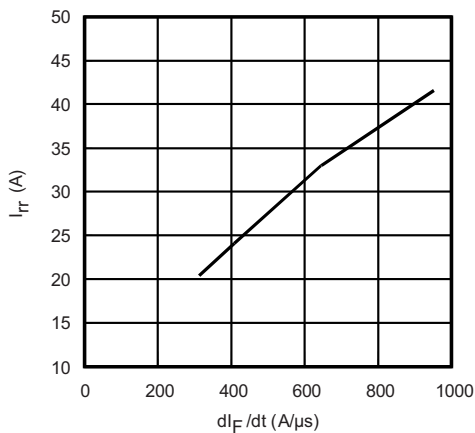

Fig. 19 - Typical Diode I_{rr} vs. dI_F/dt
 $V_{CC} = 600\text{ V}$; $V_{GE} = 15\text{ V}$; $I_{CE} = 40\text{ A}$; $T_J = 125\text{ }^\circ\text{C}$

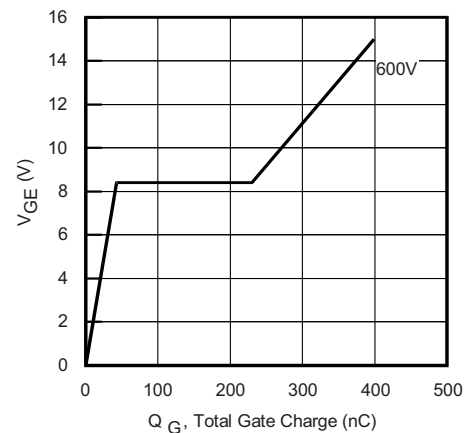

Fig. 22 - Typical Gate Charge vs. V_{GE}
 $I_{CE} = 5.0\text{ A}$; $L = 600\text{ }μ\text{H}$

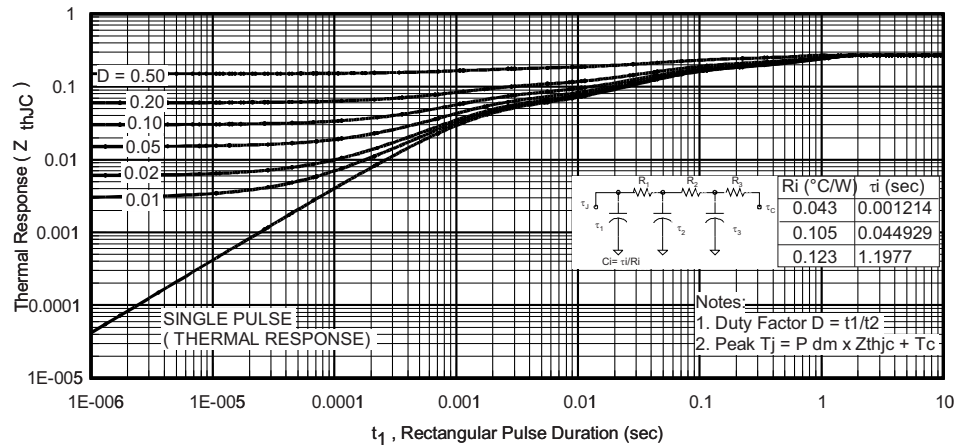

Fig. 23 - Maximum Transient Thermal Impedance, Junction to Case (IGBT)

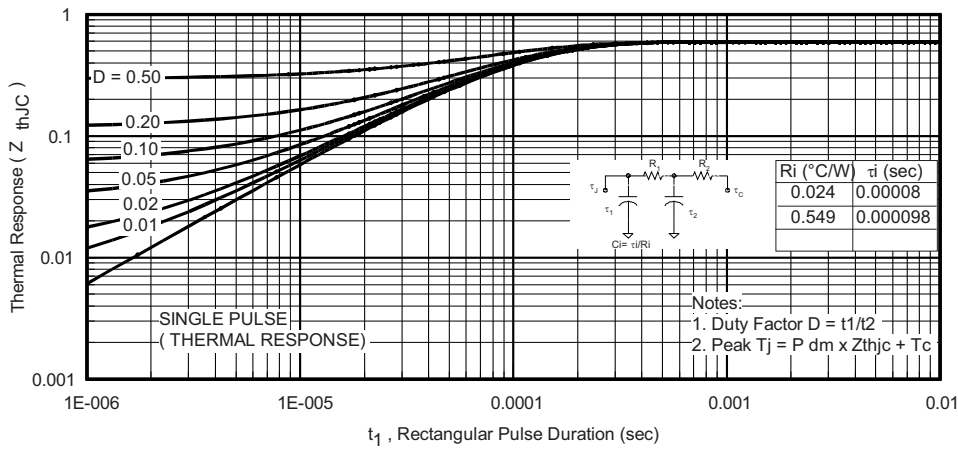

Fig. 24 - Maximum Transient Thermal Impedance, Junction to Case (Diode)

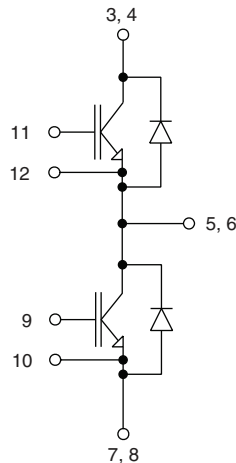

Fig. 25 - Electrical diagram

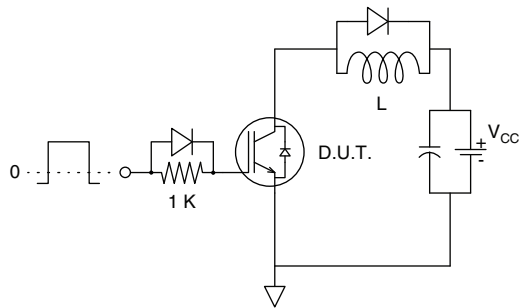

Fig. CT.1 - Gate Charge Circuit (Turn-Off)

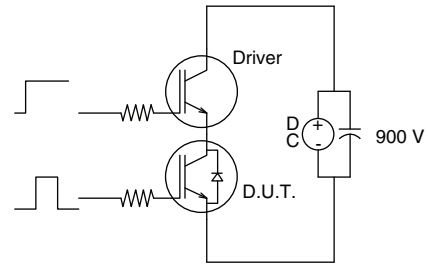

Fig. CT.3 - S.C. SOA Circuit

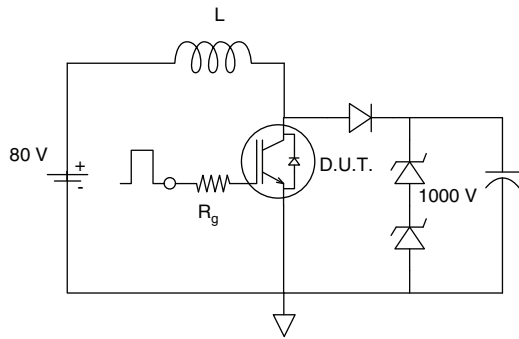

Fig. CT.2 - RBSOA Circuit

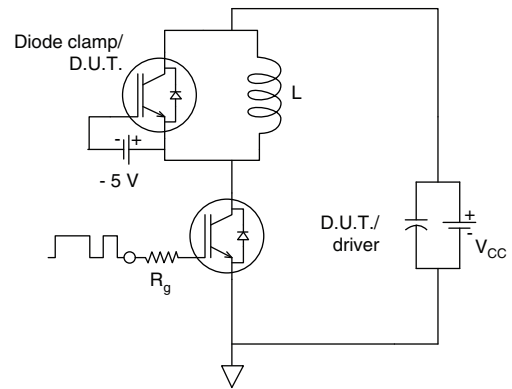

Fig. CT.4 - Switching Loss Circuit

ORDERING INFORMATION TABLE

Device code	VS-	40	MT	120	U	H	A	PbF
	1	2	3	4	5	6	7	8

- 1** - Vishay Semiconductors product
- 2** - Current rating (40 = 40 A)
- 3** - Essential part number
- 4** - Voltage code (120 = 1200 V)
- 5** - Speed / type (U = ultrafast IGBT)
- 6** - Circuit configuration (H = half bridge)
- 7** - A = Al₂O₃ DBC substrate
- 8** - PbF = lead (Pb)-free



CIRCUIT CONFIGURATION

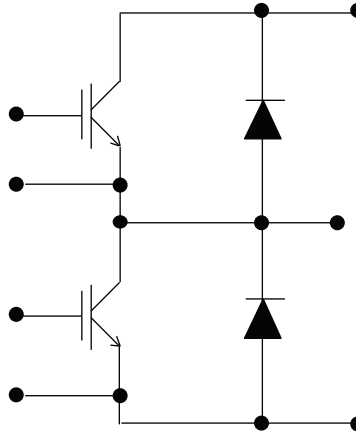

LINKS TO RELATED DOCUMENTS

LINKS TO RELATED DOCUMENTS	
Dimensions	www.vishay.com/doc?95175



MTP

DIMENSIONS in millimeters

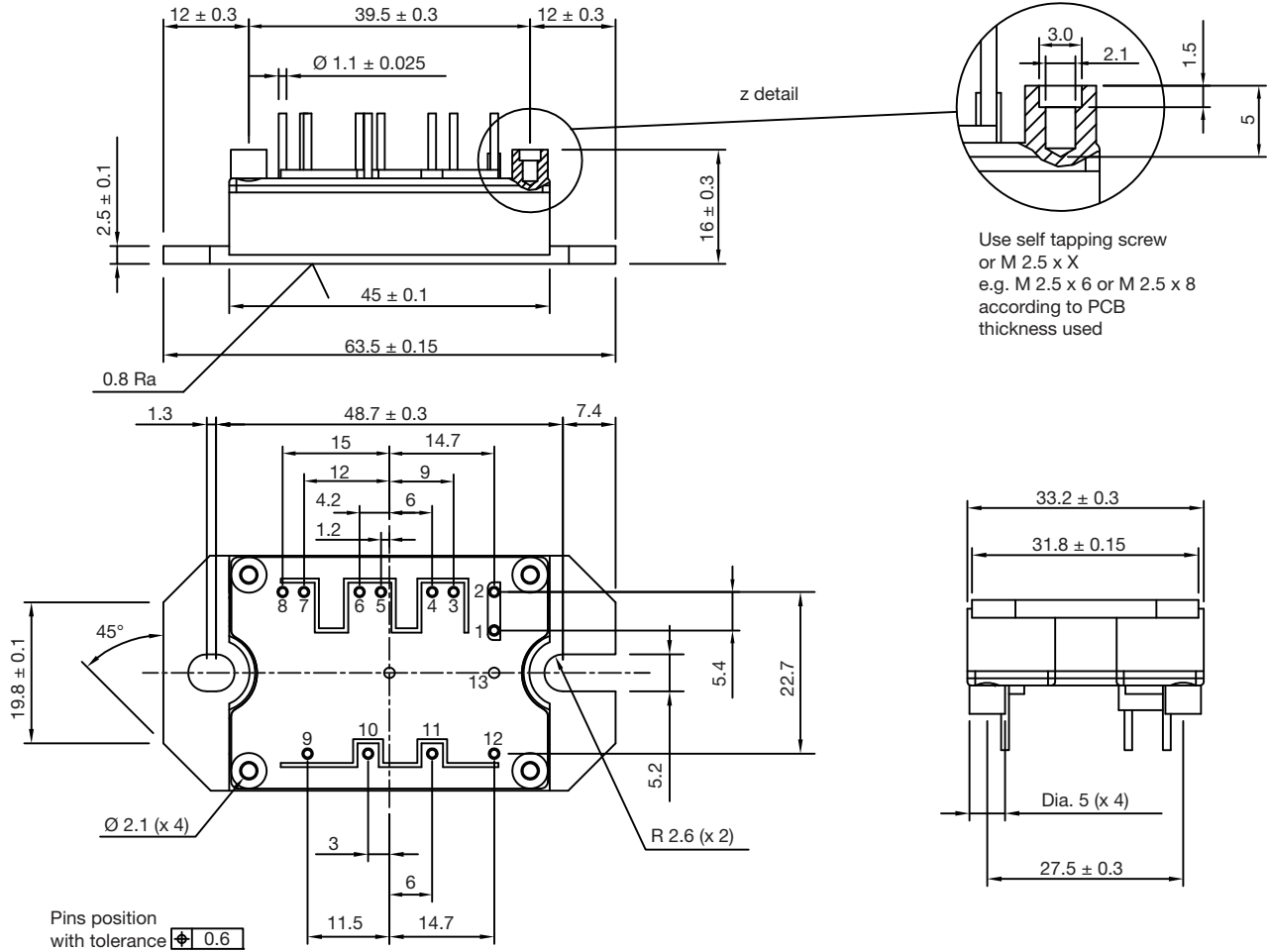

Use self tapping screw or M 2.5 x X e.g. M 2.5 x 6 or M 2.5 x 8 according to PCB thickness used

Note

- Unused terminals are not assembled in the package



Disclaimer

ALL PRODUCT, PRODUCT SPECIFICATIONS AND DATA ARE SUBJECT TO CHANGE WITHOUT NOTICE TO IMPROVE RELIABILITY, FUNCTION OR DESIGN OR OTHERWISE.

Vishay Intertechnology, Inc., its affiliates, agents, and employees, and all persons acting on its or their behalf (collectively, "Vishay"), disclaim any and all liability for any errors, inaccuracies or incompleteness contained in any datasheet or in any other disclosure relating to any product.

Vishay makes no warranty, representation or guarantee regarding the suitability of the products for any particular purpose or the continuing production of any product. To the maximum extent permitted by applicable law, Vishay disclaims (i) any and all liability arising out of the application or use of any product, (ii) any and all liability, including without limitation special, consequential or incidental damages, and (iii) any and all implied warranties, including warranties of fitness for particular purpose, non-infringement and merchantability.

Statements regarding the suitability of products for certain types of applications are based on Vishay's knowledge of typical requirements that are often placed on Vishay products in generic applications. Such statements are not binding statements about the suitability of products for a particular application. It is the customer's responsibility to validate that a particular product with the properties described in the product specification is suitable for use in a particular application. Parameters provided in datasheets and / or specifications may vary in different applications and performance may vary over time. All operating parameters, including typical parameters, must be validated for each customer application by the customer's technical experts. Product specifications do not expand or otherwise modify Vishay's terms and conditions of purchase, including but not limited to the warranty expressed therein.

Except as expressly indicated in writing, Vishay products are not designed for use in medical, life-saving, or life-sustaining applications or for any other application in which the failure of the Vishay product could result in personal injury or death. Customers using or selling Vishay products not expressly indicated for use in such applications do so at their own risk. Please contact authorized Vishay personnel to obtain written terms and conditions regarding products designed for such applications.

No license, express or implied, by estoppel or otherwise, to any intellectual property rights is granted by this document or by any conduct of Vishay. Product names and markings noted herein may be trademarks of their respective owners.

Mouser Electronics

Authorized Distributor

Click to View Pricing, Inventory, Delivery & Lifecycle Information:

[Vishay:](#)

[VS-40MT120UHAPBF](#)