



Thyristor/Diode and Thyristor/Thyristor (SUPER MAGN-A-PAK Power Modules), 500 A



SUPER MAGN-A-PAK

FEATURES

- High current capability
- High surge capability
- Industrial standard package
- 3000 V_{RMS} isolating voltage with non-toxic substrate
- UL approved file E78996 
- Compliant to RoHS directive 2002/95/EC
- Designed and qualified for industrial level



RoHS COMPLIANT

PRODUCT SUMMARY

| | |
|---------------------------|-------|
| $I_{T(AV)}$, $I_{F(AV)}$ | 500 A |
|---------------------------|-------|

MAJOR RATINGS AND CHARACTERISTICS

| SYMBOL | CHARACTERISTICS | VALUES | UNITS |
|---------------------------|-----------------|-------------|--------------------|
| $I_{T(AV)}$, $I_{F(AV)}$ | 82 °C | 500 | A |
| $I_{T(RMS)}$ | | 785 | A |
| | T_C | 82 | °C |
| I_{TSM} | 50 Hz | 17.8 | kA |
| | 60 Hz | 18.7 | |
| I^2t | 50 Hz | 1591 | kA ² s |
| | 60 Hz | 1452 | |
| $I^2\sqrt{t}$ | | 15 910 | kA ² √s |
| V_{RRM} | Range | 800 to 1600 | V |
| T_{Stg} | Range | - 40 to 150 | °C |
| T_J | Range | - 40 to 130 | |

ELECTRICAL SPECIFICATIONS

VOLTAGE RATINGS

| TYPE NUMBER | VOLTAGE CODE | V_{RRM}/V_{DRM} , MAXIMUM REPETITIVE PEAK REVERSE VOLTAGE V | V_{RSM} , MAXIMUM NON-REPETITIVE PEAK REVERSE VOLTAGE V | I_{RRM}/I_{DRM} MAXIMUM AT $T_J = T_J$ MAXIMUM mA |
|-------------|--------------|--|--|--|
| VSK.500 | 08 | 800 | 900 | 100 |
| | 12 | 1200 | 1300 | |
| | 14 | 1400 | 1500 | |
| | 16 | 1600 | 1700 | |

| ON-STATE CONDUCTION | | | | | |
|--|------------------------------|---|----------------------------|---|--------------------|
| PARAMETER | SYMBOL | TEST CONDITIONS | | VALUES | UNITS |
| Maximum average on-state current at case temperature | $I_{T(AV)}$, $I_{F(AV)}$ | 180° conduction, half sine wave | | 500 | A |
| | | | | 82 | °C |
| Maximum RMS on-state current | $I_{T(RMS)}$ | 180° conduction, half sine wave at $T_C = 82\text{ °C}$ | | 785 | A |
| Maximum peak, one-cycle, non-repetitive on-state surge current | I_{TSM} , I_{FSM} | t = 10 ms | No voltage reappplied | Sinusoidal half wave, initial $T_J = T_J$ maximum | kA |
| | | t = 8.3 ms | | | |
| | | t = 10 ms | 100 % V_{RRM} reappplied | | |
| | | t = 8.3 ms | | | |
| Maximum I^2t for fusing | I^2t | t = 10 ms | No voltage reappplied | | kA ² s |
| | | t = 8.3 ms | | | |
| | | t = 10 ms | 100 % V_{RRM} reappplied | | |
| | | t = 8.3 ms | | | |
| Maximum $I^2\sqrt{t}$ for fusing | $I^2\sqrt{t}$ | t = 0.1 ms to 10 ms, no voltage reappplied | | 15 910 | kA ² √s |
| Low level value or threshold voltage | $V_{T(TO)1}$ | (16.7 % $\times \pi \times I_{T(AV)} < I < \pi \times I_{T(AV)}$, $T_J = T_J$ maximum) | | 0.85 | V |
| High level value of threshold voltage | $V_{T(TO)2}$ | (I $> \pi \times I_{T(AV)}$, $T_J = T_J$ maximum) | | 0.93 | |
| Low level value on-state slope resistance | r_{t1} | (16.7 % $\times \pi \times I_{T(AV)} < I < \pi \times I_{T(AV)}$, $T_J = T_J$ maximum) | | 0.36 | mΩ |
| High level value on-state slope resistance | r_{t2} | (I $> \pi \times I_{T(AV)}$, $T_J = T_J$ maximum) | | 0.32 | |
| Maximum on-state voltage drop | V_{TM} | $I_{pk} = 1500\text{ A}$, $T_J = 25\text{ °C}$, $t_p = 10\text{ ms}$ sine pulse | | 1.50 | V |
| Maximum forward voltage drop | V_{FM} | $I_{pk} = 1500\text{ A}$, $T_J = 25\text{ °C}$, $t_p = 10\text{ ms}$ sine pulse | | 1.50 | V |
| Maximum holding current | I_H | $T_J = 25\text{ °C}$, anode supply 12 V resistive load | | 500 | mA |
| Maximum latching current | I_L | | | 1000 | |

| SWITCHING | | | | | |
|---|---------|---|--|--------|-------|
| PARAMETER | SYMBOL | TEST CONDITIONS | | VALUES | UNITS |
| Maximum rate of rise of turned-on current | di/dt | $T_J = T_J$ maximum, $I_{TM} = 400\text{ A}$, V_{DRM} applied | | 1000 | A/μs |
| Typical delay time | t_d | Gate current 1 A, $di_g/dt = 1\text{ A}/\mu\text{s}$ $V_d = 0.67\% V_{DRM}$, $T_J = 25\text{ °C}$ | | 2.0 | μs |
| Typical turn-off time | t_q | $I_{TM} = 750\text{ A}$; $T_J = T_J$ maximum, $di/dt = -60\text{ A}/\mu\text{s}$, $V_R = 50\text{ V}$, $dV/dt = 20\text{ V}/\mu\text{s}$, gate 0 V 100 Ω | | 200 | |

| BLOCKING | | | | | |
|--|--------------------------|--|--|--------|-------|
| PARAMETER | SYMBOL | TEST CONDITIONS | | VALUES | UNITS |
| Maximum critical rate of rise of off-state voltage | dV/dt | $T_J = 130\text{ °C}$, linear to $V_D = 80\% V_{DRM}$ | | 1000 | V/μs |
| RMS insulation voltage | V_{INS} | t = 1 s | | 3000 | V |
| Maximum peak reverse and off-state leakage current | I_{RRM} , I_{DRM} | $T_J = T_J$ maximum, rated V_{DRM}/V_{RRM} applied | | 100 | mA |



VSKT500-..PbF, VSKH500-..PbF, VSKL500-..PbF

Thyristor/Diode and Thyristor/Thyristor Vishay Semiconductors
(SUPER MAGN-A-PAK Power Modules), 500 A

| TRIGGERING | | | | |
|---|-------------|--|--------|-------|
| PARAMETER | SYMBOL | TEST CONDITIONS | VALUES | UNITS |
| Maximum peak gate power | P_{GM} | $T_J = T_J$ maximum, $t_p \leq 5$ ms | 10 | W |
| Maximum peak average gate power | $P_{G(AV)}$ | $T_J = T_J$ maximum, $f = 50$ Hz, $d\% = 50$ | 2.0 | |
| Maximum peak positive gate current | $+I_{GM}$ | $T_J = T_J$ maximum, $t_p \leq 5$ ms | 3.0 | A |
| Maximum peak positive gate voltage | $+V_{GM}$ | | 20 | V |
| Maximum peak negative gate voltage | $-V_{GM}$ | | 5.0 | |
| Maximum DC gate current required to trigger | I_{GT} | $T_J = 25$ °C, $V_{ak} 12$ V | 200 | mA |
| DC gate voltage required to trigger | V_{GT} | | 3.0 | V |
| DC gate current not to trigger | I_{GD} | $T_J = T_J$ maximum | 10 | mA |
| DC gate voltage not to trigger | V_{GD} | | 0.25 | V |

| THERMAL AND MECHANICAL SPECIFICATIONS | | | | |
|---|------------------|--|------------------|-------|
| PARAMETER | SYMBOL | TEST CONDITIONS | VALUES | UNITS |
| Maximum junction operating temperature range | T_J | | - 40 to 130 | °C |
| Maximum storage temperature range | T_{Stg} | | - 40 to 150 | |
| Maximum thermal resistance, junction to case per junction | R_{thJC} | DC operation | 0.065 | K/W |
| Maximum thermal resistance, case to heatsink | R_{thC-hs} | | 0.02 | |
| Mounting torque ± 10 % | SMAP to heatsink | A mounting compound is recommended and the torque should be rechecked after a period of 3 hours to allow for the spread of the compound. | 6 to 8 | Nm |
| | busbar to SMAP | | 12 to 15 | |
| Approximate weight | | | 1500 | g |
| Case style | | See dimensions - link at the end of datasheet | SUPER MAGN-A-PAK | |

| ΔR_{thJC} CONDUCTION | | | | |
|------------------------------|-----------------------|------------------------|---------------------|-------|
| CONDUCTION ANGLE | SINUSOIDAL CONDUCTION | RECTANGULAR CONDUCTION | TEST CONDITIONS | UNITS |
| 180° | 0.009 | 0.006 | $T_J = T_J$ maximum | K/W |
| 120° | 0.011 | 0.011 | | |
| 90° | 0.014 | 0.015 | | |
| 60° | 0.021 | 0.022 | | |
| 30° | 0.037 | 0.038 | | |

Note

- Table shows the increment of thermal resistance R_{thJC} when devices operate at different conduction angles than DC

VSKT500-..PbF, VSKH500-..PbF, VSKL500-..PbF



Vishay Semiconductors Thyristor/Diode and Thyristor/Thyristor
(SUPER MAGN-A-PAK Power Modules), 500 A

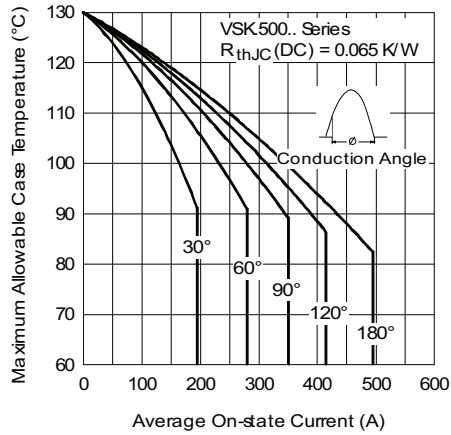

Fig. 1 - Current Ratings Characteristics

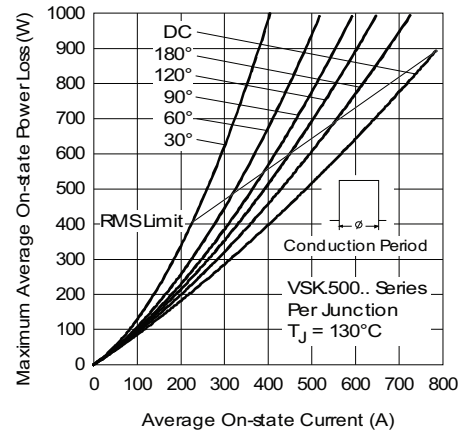

Fig. 4 - On-State Power Loss Characteristics

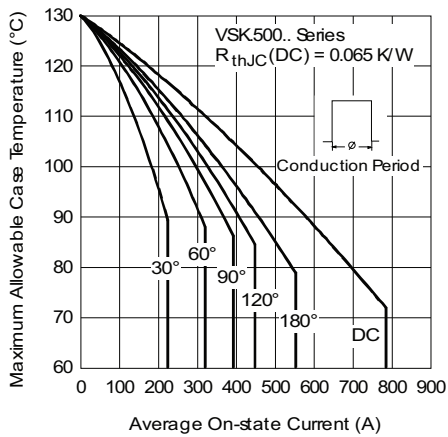

Fig. 2 - Current Ratings Characteristics

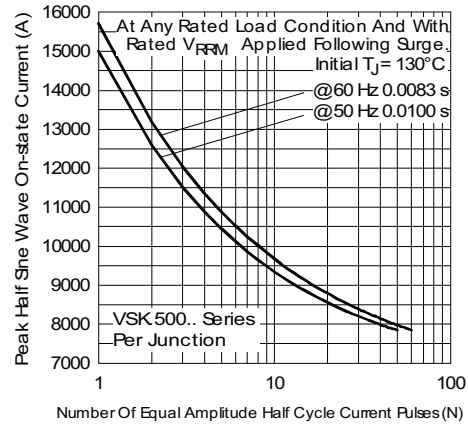

Fig. 5 - Maximum Non-Repetitive Surge Current

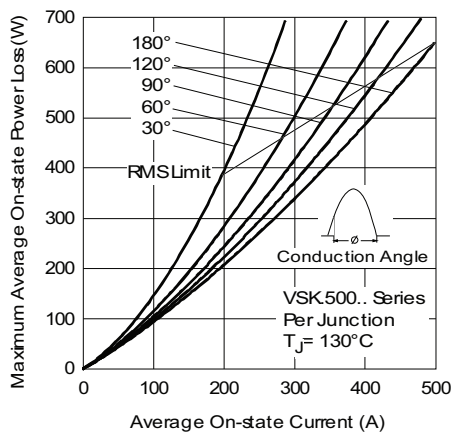

Fig. 3 - On-State Power Loss Characteristics

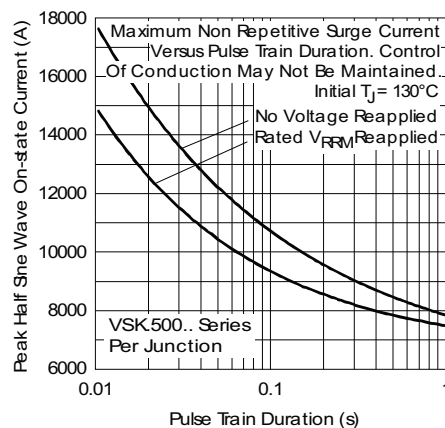

Fig. 6 - Maximum Non-Repetitive Surge Current



VSKT500-..PbF, VSKH500-..PbF, VSKL500-..PbF

Thyristor/Diode and Thyristor/Thyristor Vishay Semiconductors
(SUPER MAGN-A-PAK Power Modules), 500 A

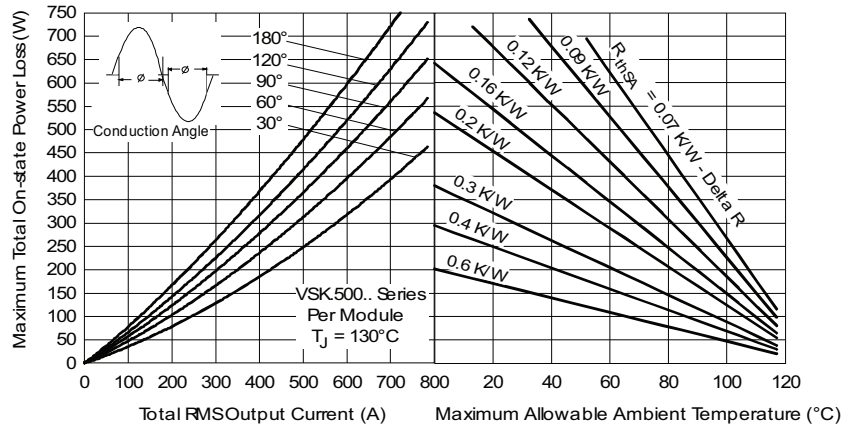

Fig. 7 - On-State Power Loss Characteristics

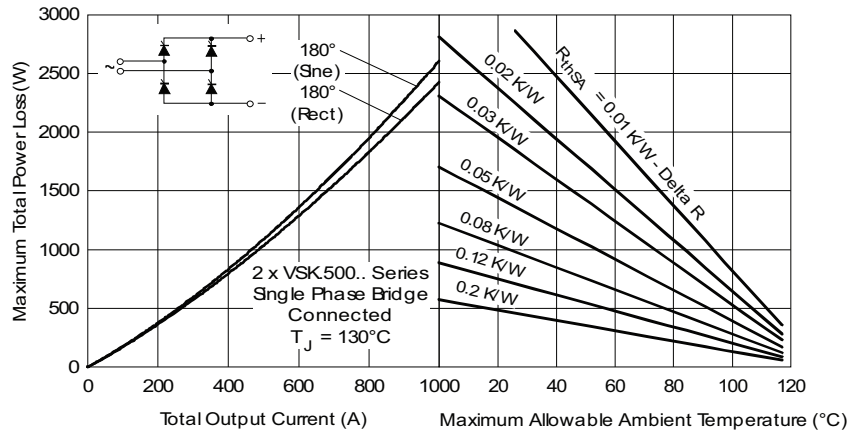

Fig. 8 - On-State Power Loss Characteristics

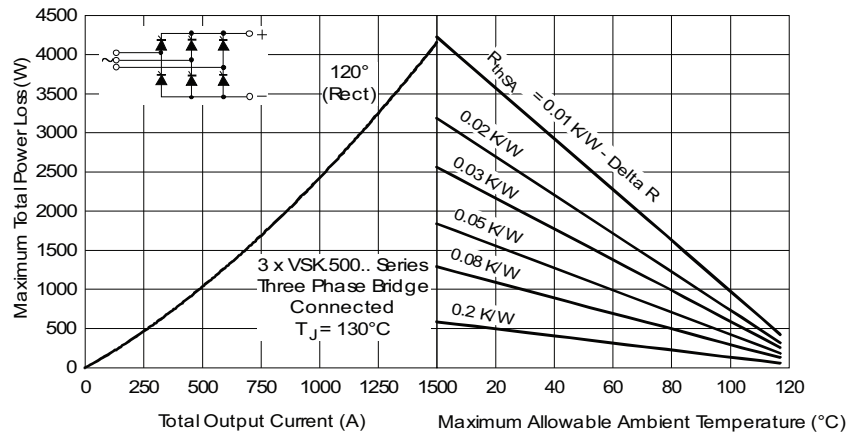

Fig. 9 - On-State Power Loss Characteristics

VSKT500-..PbF, VSKH500-..PbF, VSKL500-..PbF



Vishay Semiconductors Thyristor/Diode and Thyristor/Thyristor
(SUPER MAGN-A-PAK Power Modules), 500 A

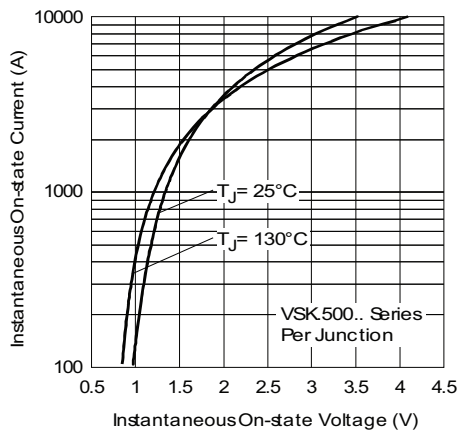

Fig. 10 - On-State Voltage Drop Characteristics

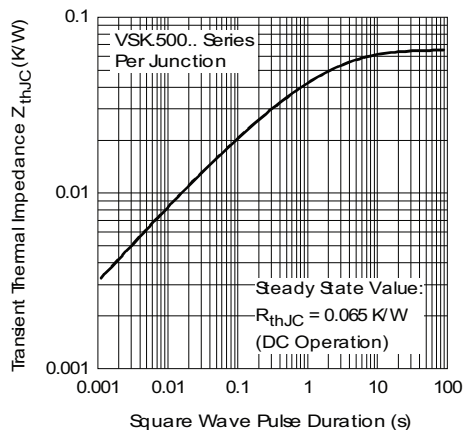

Fig. 11 - Thermal Impedance Z_{thJC} Characteristics

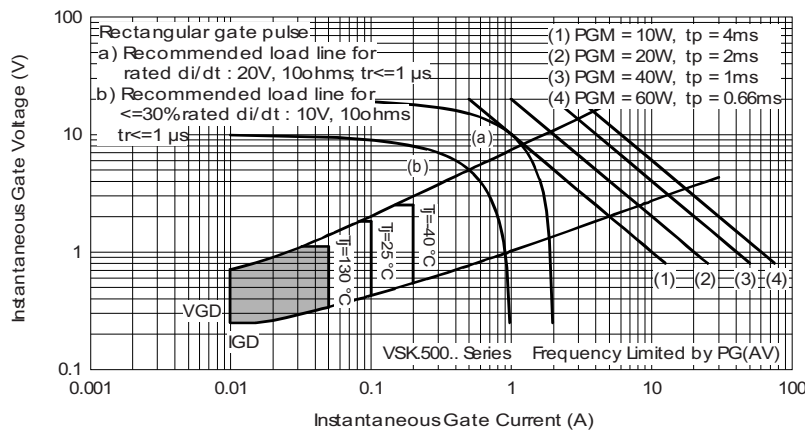

Fig. 12 - Gate Characteristics

ORDERING INFORMATION TABLE

| | | | | | | |
|-------------|------------|----------|--|----------|-----------|------------|
| Device code | VSK | T | 500 | - | 16 | PbF |
| | ① | ② | ③ | | ④ | ⑤ |
| | 1 | - | Module type | | | |
| | 2 | - | Circuit configuration (see end of datasheet) | | | |
| | 3 | - | Current rating | | | |
| | 4 | - | Voltage code x 100 = V_{RRM} (see Voltage Ratings table) | | | |
| | 5 | - | Lead (Pb)-free | | | |

Note

- To order the optional hardware go to www.vishay.com/doc?95172



VSKT500-..PbF, VSKH500-..PbF, VSKL500-..PbF

Thyristor/Diode and Thyristor/Thyristor Vishay Semiconductors
(SUPER MAGN-A-PAK Power Modules), 500 A

CIRCUIT CONFIGURATION

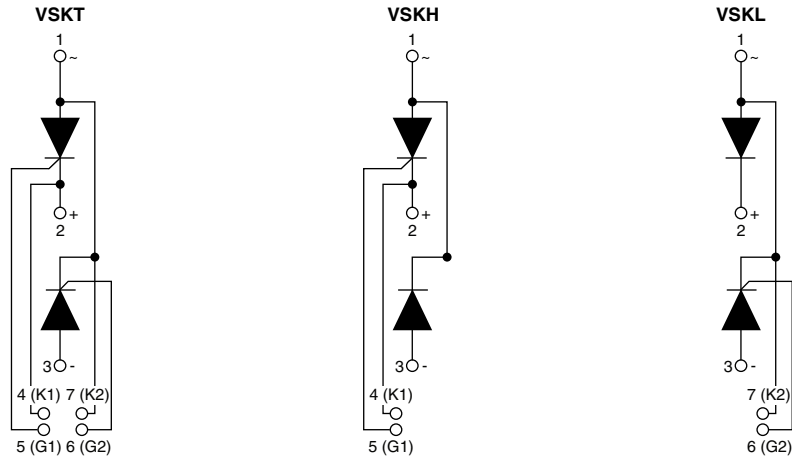

LINKS TO RELATED DOCUMENTS

Dimensions

www.vishay.com/doc?95283

Super MAGN-A-PAK Thyristor/Diode

DIMENSIONS in millimeters (inches)

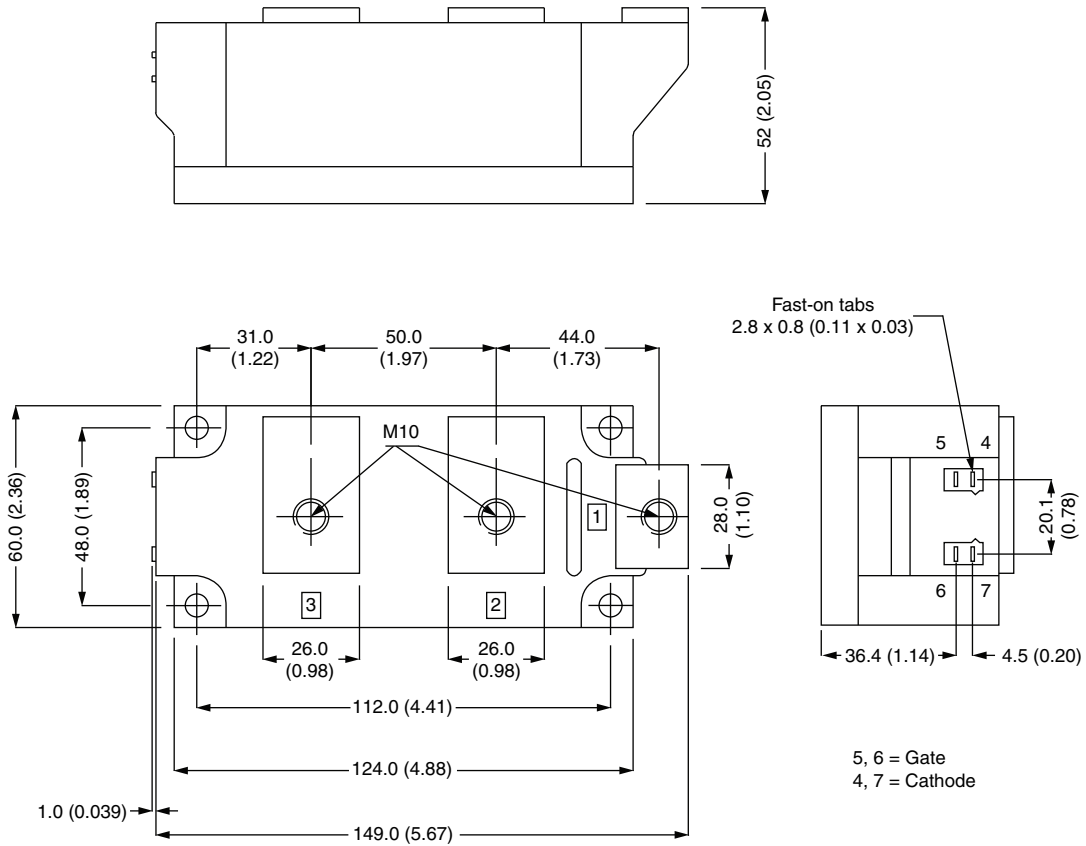



Disclaimer

ALL PRODUCT, PRODUCT SPECIFICATIONS AND DATA ARE SUBJECT TO CHANGE WITHOUT NOTICE TO IMPROVE RELIABILITY, FUNCTION OR DESIGN OR OTHERWISE.

Vishay Intertechnology, Inc., its affiliates, agents, and employees, and all persons acting on its or their behalf (collectively, "Vishay"), disclaim any and all liability for any errors, inaccuracies or incompleteness contained in any datasheet or in any other disclosure relating to any product.

Vishay makes no warranty, representation or guarantee regarding the suitability of the products for any particular purpose or the continuing production of any product. To the maximum extent permitted by applicable law, Vishay disclaims (i) any and all liability arising out of the application or use of any product, (ii) any and all liability, including without limitation special, consequential or incidental damages, and (iii) any and all implied warranties, including warranties of fitness for particular purpose, non-infringement and merchantability.

Statements regarding the suitability of products for certain types of applications are based on Vishay's knowledge of typical requirements that are often placed on Vishay products in generic applications. Such statements are not binding statements about the suitability of products for a particular application. It is the customer's responsibility to validate that a particular product with the properties described in the product specification is suitable for use in a particular application. Parameters provided in datasheets and/or specifications may vary in different applications and performance may vary over time. All operating parameters, including typical parameters, must be validated for each customer application by the customer's technical experts. Product specifications do not expand or otherwise modify Vishay's terms and conditions of purchase, including but not limited to the warranty expressed therein.

Except as expressly indicated in writing, Vishay products are not designed for use in medical, life-saving, or life-sustaining applications or for any other application in which the failure of the Vishay product could result in personal injury or death. Customers using or selling Vishay products not expressly indicated for use in such applications do so at their own risk and agree to fully indemnify and hold Vishay and its distributors harmless from and against any and all claims, liabilities, expenses and damages arising or resulting in connection with such use or sale, including attorneys fees, even if such claim alleges that Vishay or its distributor was negligent regarding the design or manufacture of the part. Please contact authorized Vishay personnel to obtain written terms and conditions regarding products designed for such applications.

No license, express or implied, by estoppel or otherwise, to any intellectual property rights is granted by this document or by any conduct of Vishay. Product names and markings noted herein may be trademarks of their respective owners.