



WS58P20SMB-BH

Power Transient Voltage Suppressor

Features

- 2000 watts Peak Pulse Power (10/1000µs)
- Bidirectional Protection
- Fast Response Time: Typically < 1ns
- Excellent Clamping Capability
- Glass Passivated Junction
- Built-in Strain relief
- Low inductance
- Low profile package
- IEC 61000-4-2 (ESD) ±30kV(air), ±30kV(contact)
- MSL: Level 1

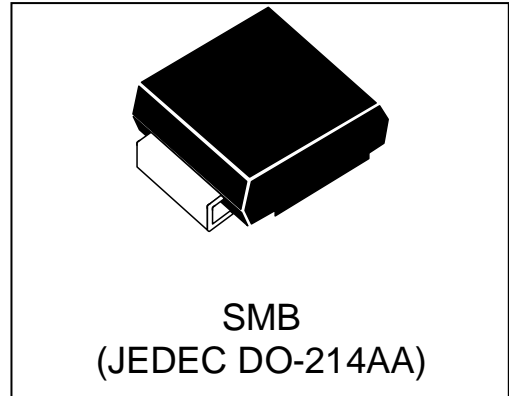

Mechanical Characteristics

- JEDEC DO-214AA package
- Molding compound flammability rating: UL 94V-0
- Marking: Marking Code
- Packaging : Tape and Reel per EIA 481
- RoHS & HF Compliant

Applications

- I/O Interfaces
- Power lines
- Telecommunication
- Computers & Consumer Electronics
- Industrial Electronics

Absolute Maximum Rating			
Rating	Symbol	Value	Units
Peak Pulse Power (tp =10/1000µs) (see Note1,2)	P _{PPM}	2000	Watts
Non-repetitive peak impulse Voltage 10/700µs (ITU-T K.20, K.21 & K.45, K.44)	V _{PPSM}	4000	V
Peak pulse current (10/1000µs) (see Note2)	I _{PP}	22.0	A
Power Dissipation on infinite heat sink T _L = 50 °C (Fig4)	P _D	6.5	W
Operating Junction Temperature range	T _J	-65 to + 150	°C
Storage Temperature range	T _{STG}	-65 to + 150	°C

Note1: Peak Pulse Power Rating as Pulse Width ,per Fig1.

Note2: Peak Pulse Power or Current Derated above T_A=25°C Per Fig. 2 and Non-Repetitive Current Pulse,Per Fig.3.

Pin Configuration

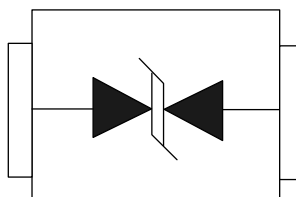

Electrical Characteristics

Symbol	Parameter
I_{PP}	Maximum Reverse Peak Pulse Current
V_C	Clamping Voltage @ I_{PP}
V_{RWM}	Working Peak Reverse Voltage
I_R	Maximum Reverse Leakage Current @ V_{RWM}
V_{BR}	Breakdown Voltage @ I_T
I_T	Test Current

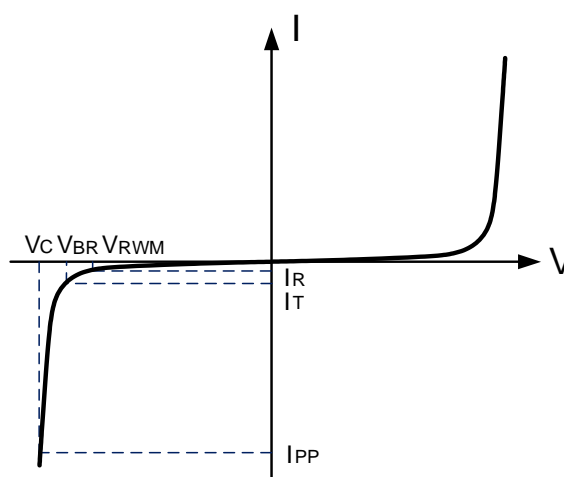

WS58P20SMB-BH					
Parameter	Symbol	Conditions	Minimum	Maximum	Units
Reverse Stand-Off Voltage	V_{RWM}			58	V
Reverse Breakdown Voltage	V_{BR}	$I_T=1mA$	62	71.2	V
Reverse Leakage Current	I_R	$V_{RWM}=58V, T=25^{\circ}C$		1	μA
Clamping Voltage	V_C	$I_{PP}=22.0A, t_p=10/1000\mu s$		93.6	V
Clamping Voltage	V_C	$V_{PPSM}=4KV, t_p=10/700\mu s$		90	V

Typical Characteristics

Figure 1: Peak Pulse Power Rating Curve

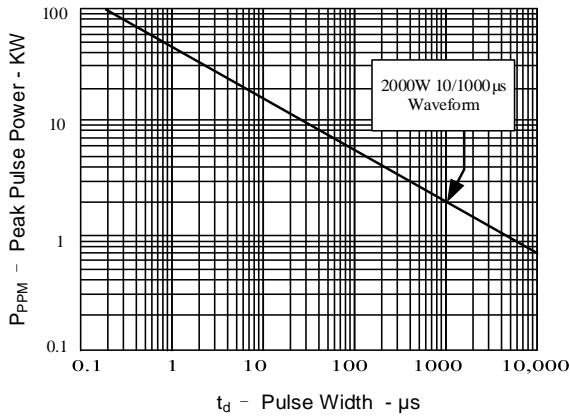

Figure 2: Pulse Derating Curve

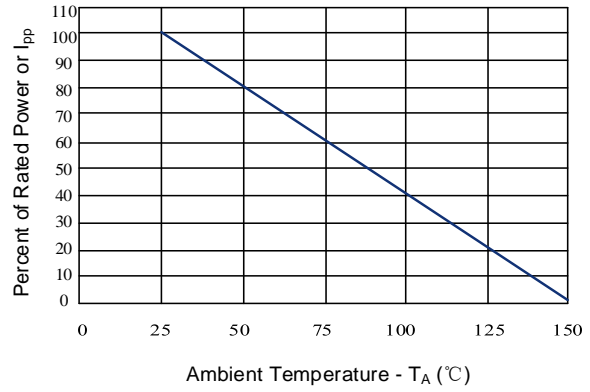

Figure 3: Pulse Waveform

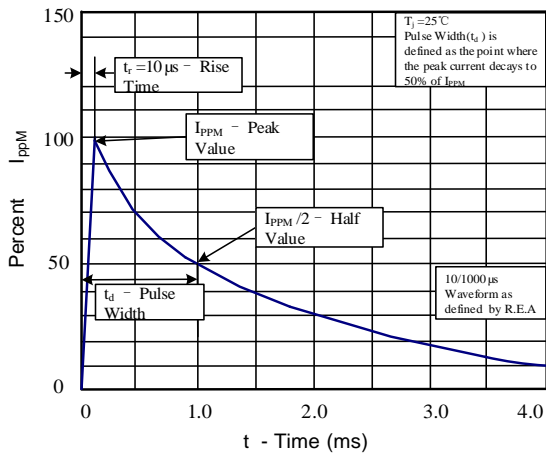
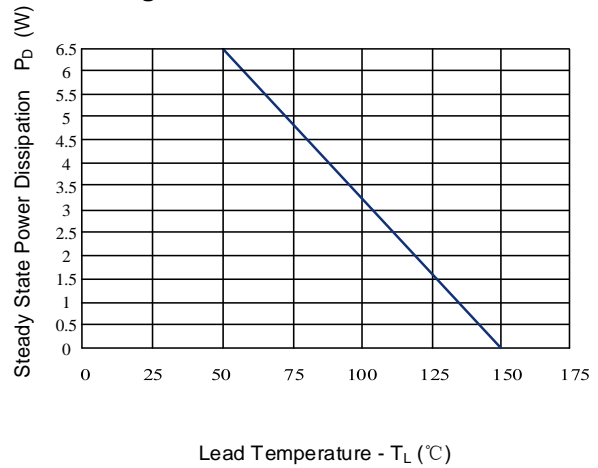
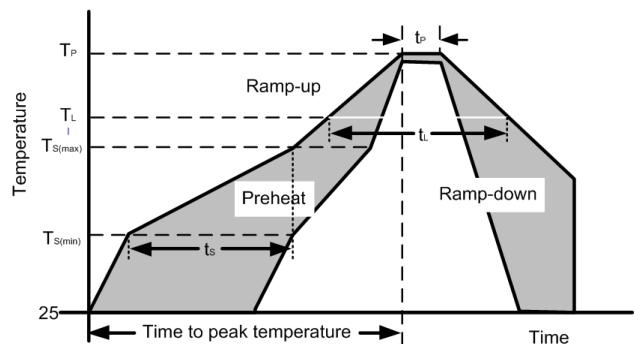

Figure 4: Steady State Power Dissipation Derating Curve



Recommended Soldering Parameters

Reflow Condition		
Pre-Heat	Temperature min ($T_{s(min)}$)	150°C
	Temperature max ($T_{s(max)}$)	200°C
	Time (min to max) (t_s)	60-190 s
Average ramp up rate (Liquidus Temp) (T_L) to peak		3°C/s max
Ts(max) to TL - Ramp-up Rate		3°C/s max
Reflow	Temperature (T_L) (Liquidus)	217°C
	Temperature (t_L)	60-150 s
Peak Temperature (T_P)		260 ^{+0/-5} °C
Time within actual peak Temperature (t_p)		20-40 s
Ramp-down Rate		5°C/s max
Time 25°C to peak Temperature (T_P)		8 minutes max
Do not exceed		260°C



Outline Drawing – SMB(DO-214AA)

Ref. (mm)	Millimeters	
	Min.	Max.
A	2.130	2.600
A1	-	0.300
B	1.900	2.200
E	4.100	4.750
E1	5.210	5.590
D	3.300	3.940
L	0.760	1.520

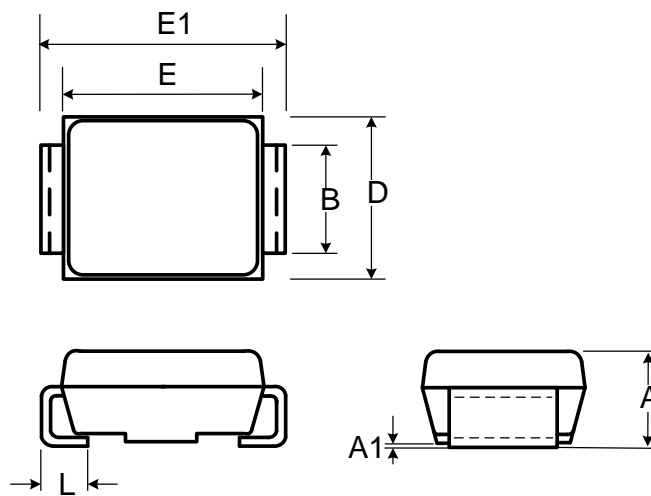

Recommended Solder Pad Layout

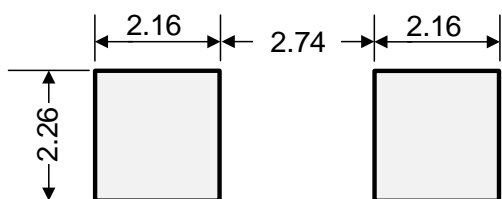

Dimensions in mm

Marking Code



Package Information

Package Type	Description	Quantity (pcs)
SMB(DO-214AA)	Tape & Reel -12mm/13" tape	3000

Tape and Reel Information

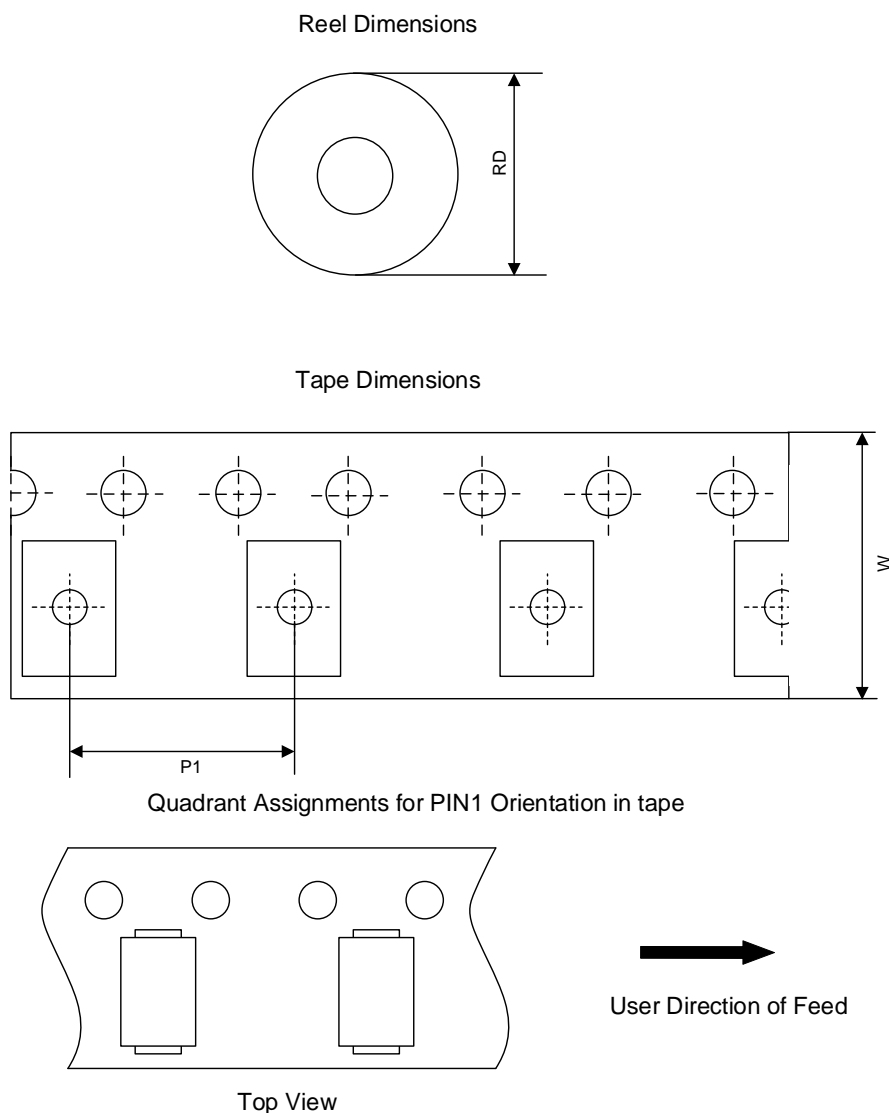

Quadrant Assignments for PIN1 Orientation in tape

RD	Reel Dimensions	13 inch
W	Overall width of the carrier tape	12 mm
P1	Pitch between successive cavity centers	8 mm

Contact Information

No.1001, Shiwan(7) Road, Pudong District, Shanghai, P.R.China.201207

Tel: 86-21-68969993 Fax: 86-21-50757680 Email: market@way-on.com

WAYON website: <http://www.way-on.com>

For additional information, please contact your local Sales Representative.

WAYON ® are registered trademarks of Wayon Corporation.

*Specifications are subject to change without notice.
The device characteristics and parameters in this data sheet can and do vary in different applications and actual device performance may vary over time.
Users should verify actual device performance in their specific applications.*