

## 100V N-Channel Enhancement Mode Power MOSFET

### Description

WMM043N10HGS uses Wayon's advanced power trench MOSFET technology that has been especially tailored to minimize the on-state resistance and yet maintain superior switching performance. This device is well suited for high efficiency fast switching applications.

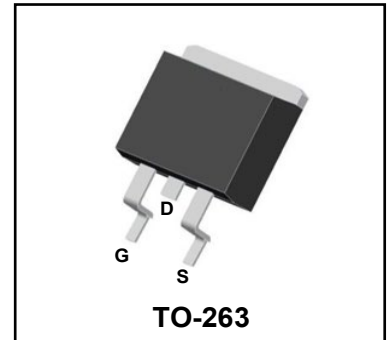

### Features

- $V_{DS} = 100V$ ,  $I_D = 145A$
- $R_{DS(on)} < 4.5m\Omega @ V_{GS} = 10V$
- Green Device Available
- Low Gate Charge
- 100% EAS Guaranteed

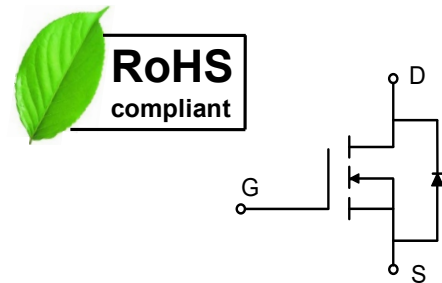

### Applications

- Power Management Switches
- DC/DC Converter
- LED Backlighting

### Absolute Maximum Ratings ( $T_A = 25^\circ C$ , unless otherwise noted)

| Parameter  | Symbol         | Value             | Unit       |
|--|----------------|-------------------|------------|
| Drain-Source Voltage                             | $V_{DS}$       | 100               | V          |
| Gate-Source Voltage                              | $V_{GS}$       | $\pm 20$          | V          |
| Continuous Drain Current                         | $I_D$          | $T_C=25^\circ C$  | 145        |
|  |                | $T_C=100^\circ C$ | 92         |
| Pulsed Drain Current <sup>1</sup>                | $I_{DM}$       | 580               | A          |
| Single Pulse Avalanche Energy <sup>2</sup>       | EAS            | 320               | mJ         |
| Total Power Dissipation                          | $P_D$          | 208               | W          |
| Operating Junction and Storage Temperature Range | $T_J, T_{STG}$ | -55 to 150        | $^\circ C$ |

### Thermal Characteristics

| Parameter  | Symbol          | Value | Unit         |
|--|-----------------|-------|--------------|
| Thermal Resistance from Junction-to-Ambient <sup>3</sup> | $R_{\theta JA}$ | 38    | $^\circ C/W$ |
| Thermal Resistance from Junction-to-Case                 | $R_{\theta JC}$ | 0.6   | $^\circ C/W$ |

**Electrical Characteristics** (T<sub>J</sub> = 25°C, unless otherwise noted)

| Parameter                                      | Symbol               | Test Conditions  | Min.                   | Typ.  | Max. | Unit |    |
|--|----------------------|--|------------------------|-------|------|------|----|
| <b>Static Characteristics</b>                  |                      |  |                        |       |      |      |    |
| Drain-Source Breakdown Voltage                 | V <sub>(BR)DSS</sub> | V <sub>GS</sub> = 0V, I <sub>D</sub> = 250μA   | 100                    | -     | -    | V    |    |
| Gate-body Leakage current                      | I <sub>gss</sub>     | V <sub>DS</sub> = 0V, V <sub>GS</sub> = ±20V   | -                      | -     | ±100 | nA   |    |
| Zero Gate Voltage Drain Current                | I <sub>DSS</sub>     | V <sub>DS</sub> = 100V, V <sub>GS</sub> = 0V   | T <sub>J</sub> = 25°C  | -     | -    | 1    | μA |
|  |                      |  | T <sub>J</sub> = 100°C | -     | -    | 100  |    |
| Gate-Threshold Voltage                         | V <sub>GS(th)</sub>  | V <sub>DS</sub> = V <sub>GS</sub> , I <sub>D</sub> = 250μA                                 | 2                      | 3     | 4    | V    |    |
| Drain-Source on-Resistance <sup>4</sup>        | R <sub>DS(on)</sub>  | V <sub>GS</sub> = 10V, I <sub>D</sub> = 20A  | -                      | 3.7   | 4.5  | mΩ   |    |
| Forward Transconductance <sup>4</sup>          | g <sub>fs</sub>      | V <sub>DS</sub> = 10V, I <sub>D</sub> = 20A  | -                      | 62    | -    | S    |    |
| <b>Dynamic Characteristics<sup>5</sup></b>     |                      |  |                        |       |      |      |    |
| Input Capacitance                              | C <sub>iss</sub>     | V <sub>DS</sub> = 50V, V <sub>GS</sub> = 0V,<br>f = 1MHz                                   | -                      | 6868  | -    | pF   |    |
| Output Capacitance                             | C <sub>oss</sub>     |  | -                      | 740   | -    |      |    |
| Reverse Transfer Capacitance                   | C <sub>rss</sub>     |  | -                      | 21    | -    |      |    |
| Gate Resistance                                | R <sub>g</sub>       | f = 1MHz   | -                      | 1.3   | -    | Ω    |    |
| <b>Switching Characteristics<sup>5</sup></b>   |                      |  |                        |       |      |      |    |
| Total Gate Charge                              | Q <sub>g</sub>       | V <sub>GS</sub> = 10V, V <sub>DS</sub> = 50V,<br>I <sub>D</sub> = 20A                      | -                      | 112.5 | -    | nC   |    |
| Gate-Source Charge                             | Q <sub>gs</sub>      |  | -                      | 30.5  | -    |      |    |
| Gate-Drain Charge                              | Q <sub>gd</sub>      |  | -                      | 27.3  | -    |      |    |
| Turn-on Delay Time                             | t <sub>d(on)</sub>   | V <sub>GS</sub> = 10V, V <sub>DD</sub> = 50V,<br>R <sub>G</sub> = 3Ω, I <sub>D</sub> = 20A | -                      | 33    | -    | ns   |    |
| Rise Time                                      | t <sub>r</sub>       |  | -                      | 39    | -    |      |    |
| Turn-off Delay Time                            | t <sub>d(off)</sub>  |  | -                      | 67.1  | -    |      |    |
| Fall Time                                      | t <sub>f</sub>       |  | -                      | 32    | -    |      |    |
| Body Diode Reverse Recovery Time               | t <sub>rr</sub>      | I <sub>F</sub> = 20A, dI/dt = 100A/μs  | -                      | 58.7  | -    | ns   |    |
| Body Diode Reverse Recovery Charge             | Q <sub>rr</sub>      |  | -                      | 97.3  | -    | nC   |    |
| <b>Drain-Source Body Diode Characteristics</b> |                      |  |                        |       |      |      |    |
| Diode Forward Voltage <sup>4</sup>             | V <sub>SD</sub>      | I <sub>S</sub> = 20A, V <sub>GS</sub> = 0V   | -                      | -     | 1.2  | V    |    |
| Continuous Source Current                      | I <sub>S</sub>       | T <sub>C</sub> = 25°C  | -                      | -     | 145  | A    |    |

## Notes:

1. Repetitive rating, pulse width limited by junction temperature T<sub>J(MAX)</sub> = 150°C.
2. The EAS data shows Max. rating . The test condition is V<sub>DD</sub> = 35V, V<sub>GS</sub> = 10V, L = 0.4mH, I<sub>AS</sub> = 40A.
3. The data tested by surface mounted on a 1 inch<sup>2</sup> FR-4 board with 2OZ copper, The value in any given application depends on the user's specific board design.
4. The data tested by pulsed , pulse width ≤ 300us , duty cycle ≤ 2%.
5. This value is guaranteed by design hence it is not included in the production test.

### Typical Characteristics

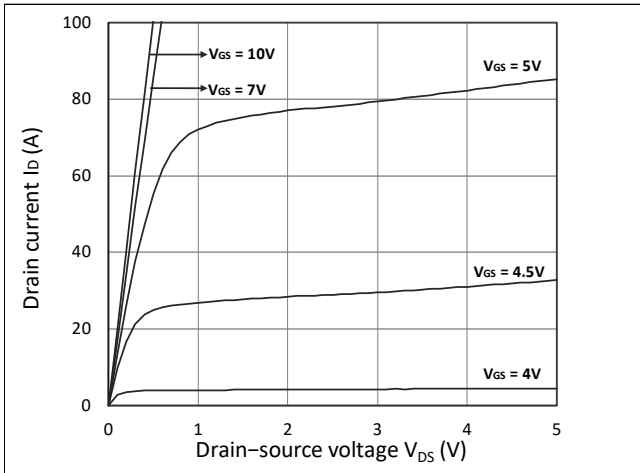

Figure 1. Output Characteristics

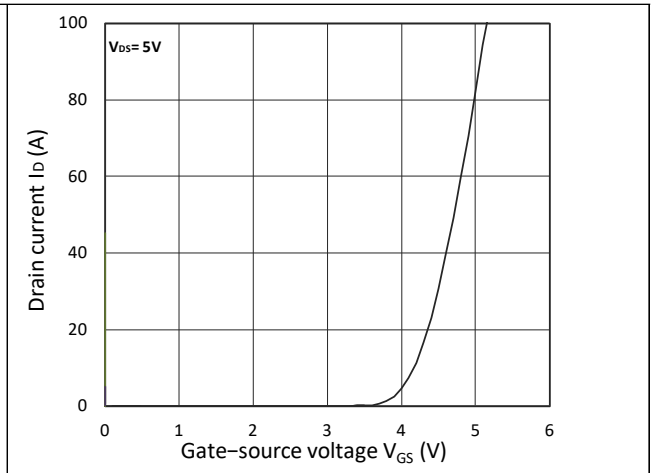

Figure 2. Transfer Characteristics

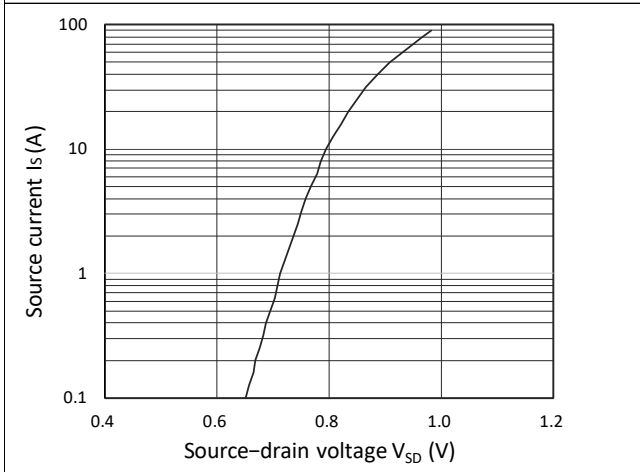

Figure 3. Forward Characteristics of Reverse

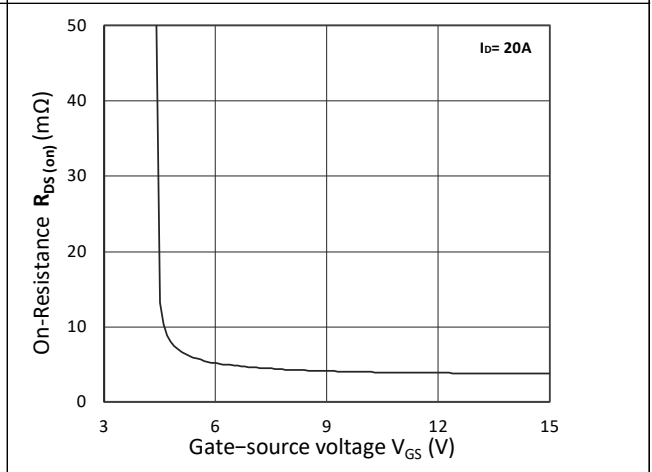

Figure 4.  $R_{DS(on)}$  vs.  $V_{GS}$

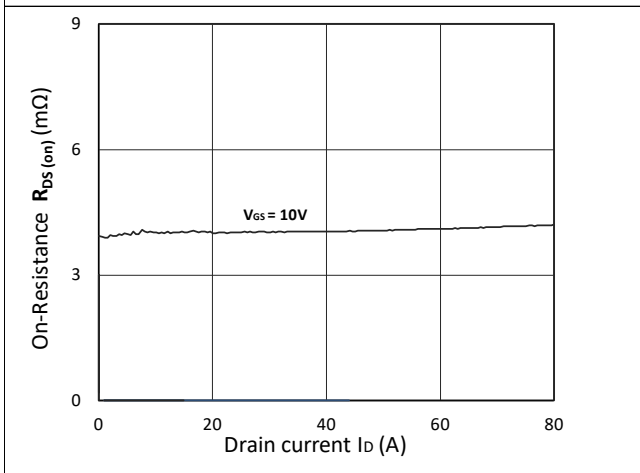

Figure 5.  $R_{DS(on)}$  vs.  $I_D$

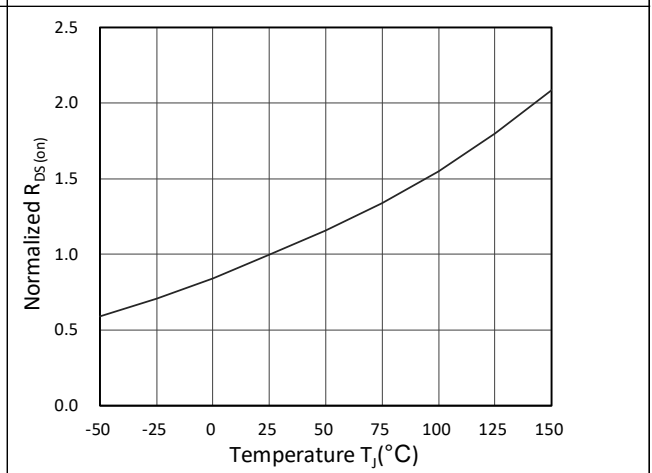

Figure 6. Normalized  $R_{DS(on)}$  vs. Temperature

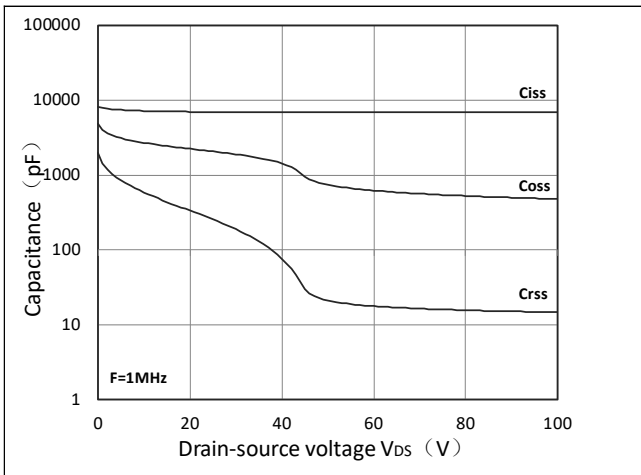

Figure 7. Capacitance Characteristics

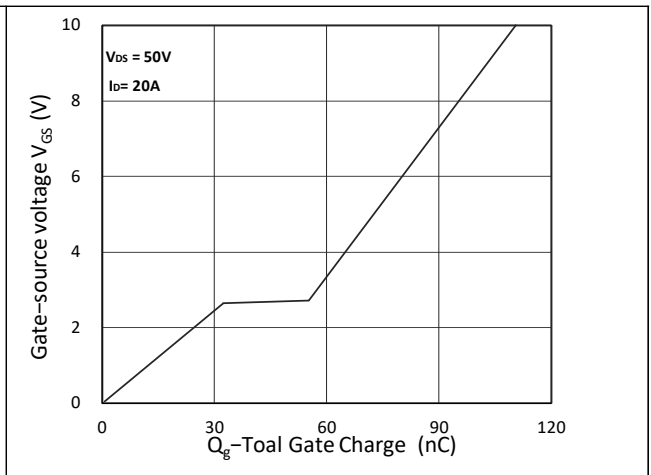

Figure 8. Gate Charge Characteristics

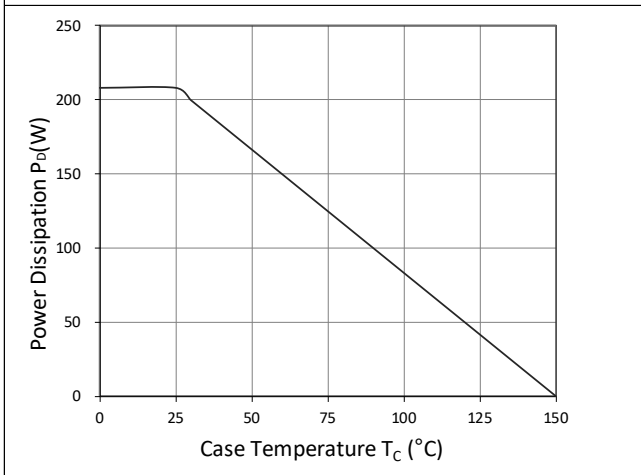

Figure 9. Power Dissipation

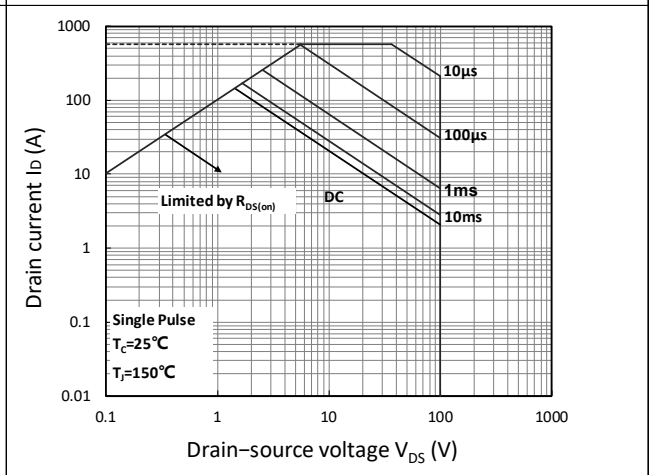

Figure 10. Safe Operating Area

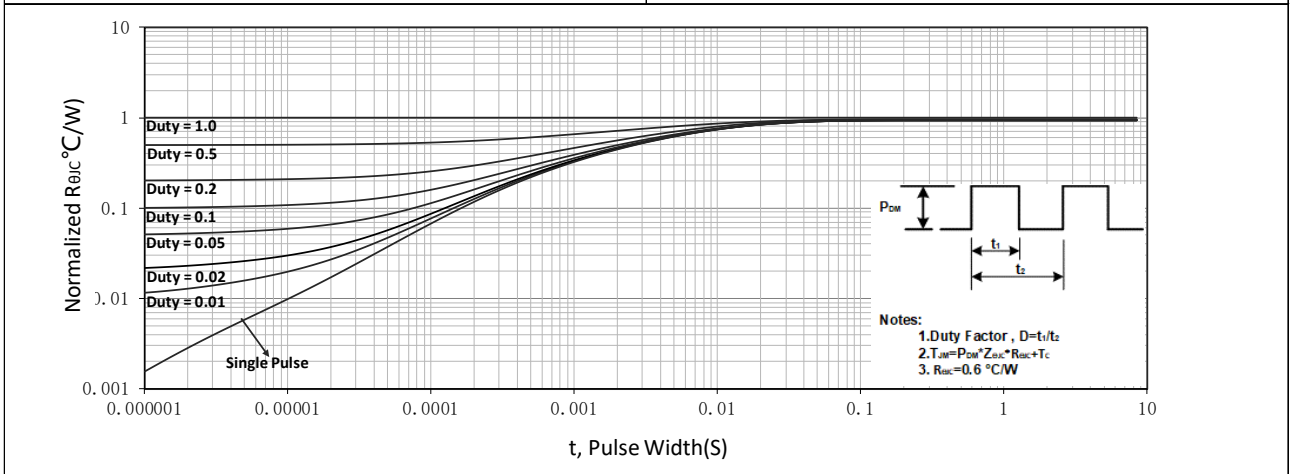

Figure 11. Normalized Maximum Transient Thermal Impedance

Test Circuit

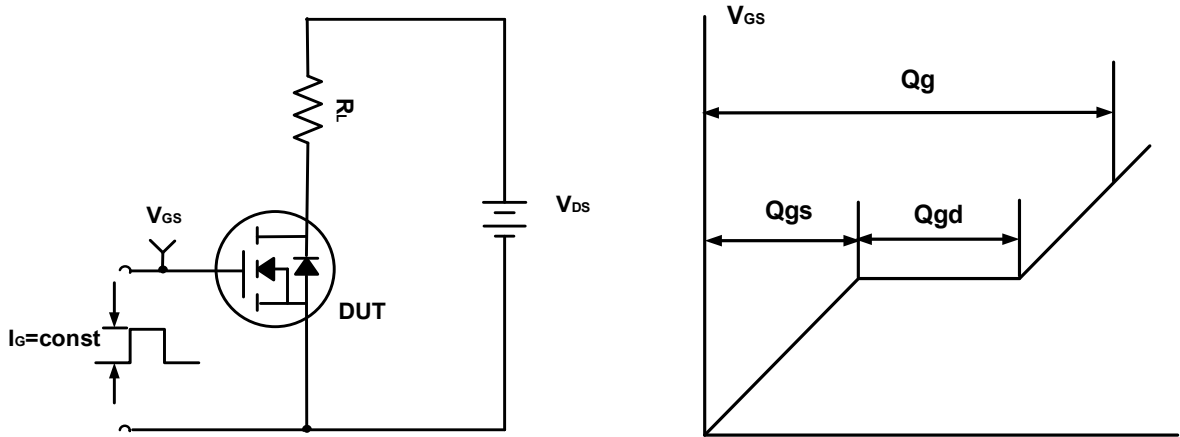

Figure A. Gate Charge Test Circuit & Waveforms

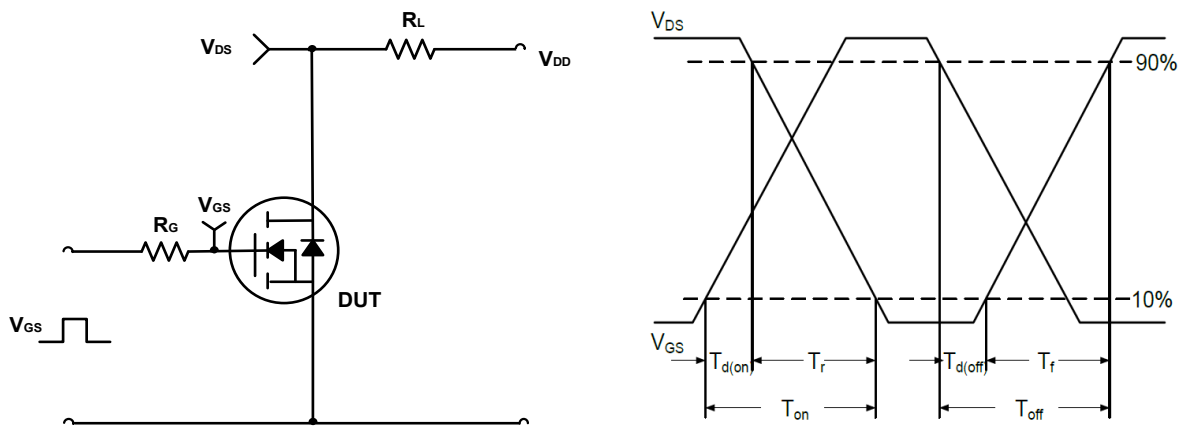

Figure B. Switching Test Circuit & Waveforms

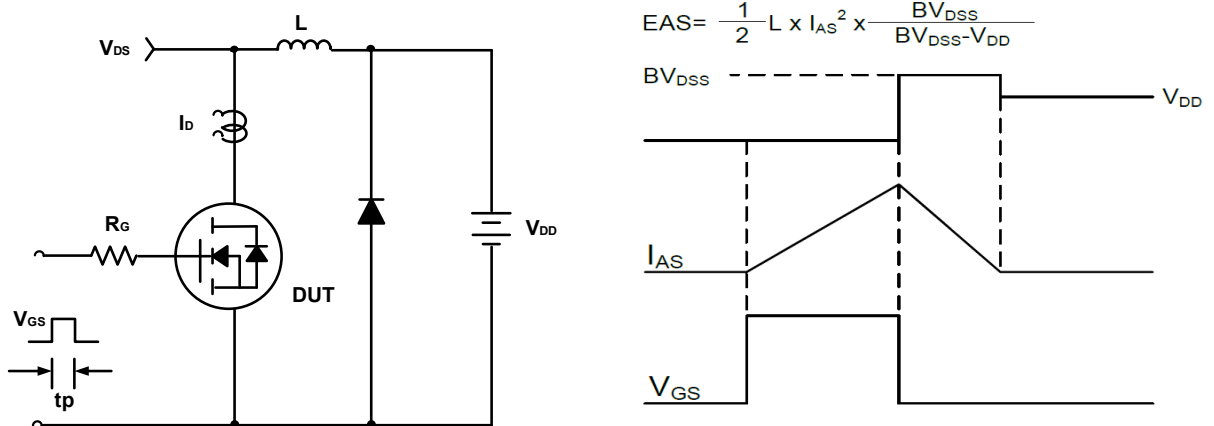
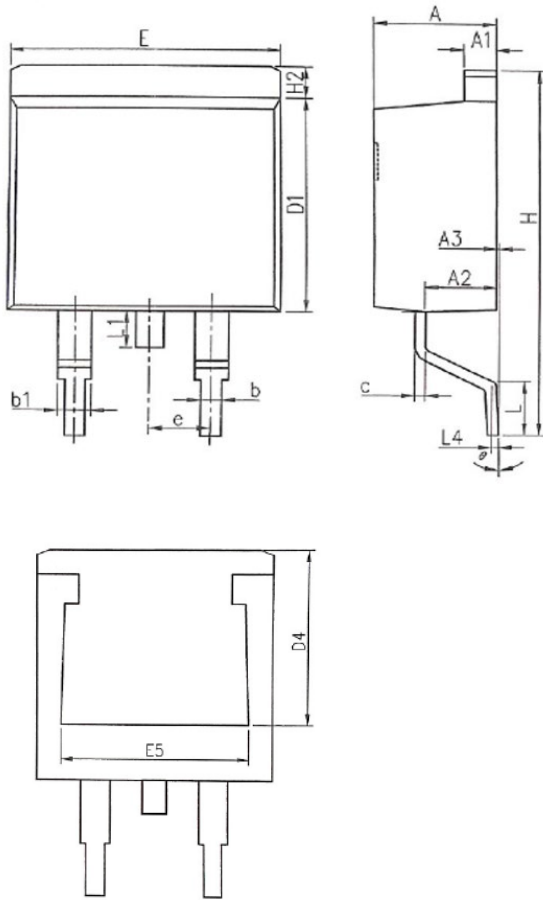

Figure C. Unclamped Inductive Switching Circuit & Waveforms

Mechanical Dimensions for TO-263

COMMON DIMENSIONS



| SYMBOL   | MM       |       |
|----------|----------|-------|
|          | MIN      | MAX   |
| A        | 4.37     | 4.89  |
| A1       | 1.17     | 1.42  |
| A2       | 2.20     | 2.90  |
| A3       | 0.00     | 0.25  |
| b        | 0.70     | 0.96  |
| b1       | 1.17     | 1.47  |
| c        | 0.28     | 0.60  |
| D1       | 8.45     | 9.30  |
| D4       | 6.60     | -     |
| E        | 9.80     | 10.40 |
| E5       | 7.06     | -     |
| e        | 2.54BSC  |       |
| H        | 14.70    | 15.70 |
| H2       | 1.07     | 1.47  |
| L        | 2.00     | 2.80  |
| L1       | -        | 1.75  |
| L4       | 0.254BSC |       |
| $\theta$ | 0°       | 9°    |

## Ordering Information

| Part         | Package | Marking      | Packing method |
|--------------|---------|--------------|----------------|
| WMM043N10HGS | TO-263  | WMM043N10HGS | Tape and Reel  |

## Marking Information

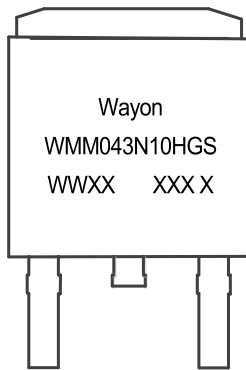

WMM043N10HGS = Device code

WWXX XXX X= Date code

## Contact Information

No.1001, Shiwan(7) Road, Pudong District, Shanghai, P.R.China.201207

Tel: 86-21-50310888 Fax: 86-21-50757680 Email: market@way-on.com

WAYON website: <http://www.way-on.com>

For additional information, please contact your local Sales Representative.

 is registered trademarks of Wayon Corporation.

## Disclaimer

WAYON reserves the right to make changes without further notice to any Products herein to improve reliability, function, or design. The Products are not designed for use in hostile environments, including, without limitation, aircraft, nuclear power generation, medical appliances, and devices or systems in which malfunction of any Product can reasonably be expected to result in a personal injury. The information given in this document shall in no event be regarded as a guarantee of conditions or characteristics. WAYON does not assume any liability for infringement of patents, copyrights, or other intellectual property rights of third parties by or arising from the use of Products or technical information described in this document.