



Temperature and Humidity Module
(Model No.ZS03)

Manual

Version: 1.6

Valid from: 2022-5-13

Zhengzhou Winsen Electronics Technology Co.,Ltd

Statement

This manual copyright belongs to Zhengzhou Winsen Electronics Technology Co., LTD.

Without the written permission, any part of this manual shall not be copied, translated, stored in database or retrieval system, also can't spread through electronic, copying, record ways.

Thanks for purchasing our product. In order to let customers use it better and reduce the faults caused by misuse, please read the manual carefully and operate it correctly in accordance with the instructions. If users disobey the terms or remove, disassemble, change the components inside of the sensor, we shall not be responsible for the loss.

The specific such as color, appearance, sizes &etc, please in kind prevail.

We are devoting ourselves to products development and technical innovation, so we reserve the right to improve the products without notice. Please confirm it is the valid version before using this manual. At the same time, users' comments on optimized using way are welcome.

Please keep the manual properly, in order to get help if you have questions during the usage in the future.

Zhengzhou Winsen Electronics Technology CO., LTD

ZS03 Temperature and Humidity Module

Profile

ZS03 is digital type of temperature and humidity module. It employs polymer resistance-type moisture sensor and NTC, and matches SCM with good performance. It has advantages of high quality, quick response, strong anti-interference &etc.

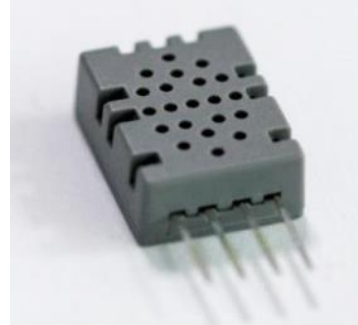

Features

- Low cost
- Low power consumption
- Small sizes
- Single wire serial interface
- High sensitivity
- Calibrated, digital output

Application

Storage, industrial production, process controlling, environment monitoring, household appliances, meteorological field

Parameters

Table 1.

Part No.	ZS03
Detection Object	Relative humidity, temperature
Operation Voltage	3.3~5.5V DC
Detection Range	20~90%RH
Accuracy for humidity detection	±5%RH (at25℃, 60%RH, Vin=3.3V)
Accuracy for temperature detection	±1℃
Operation temperature	-20~60℃
Operation humidity	20~90%RH (non-condensation)
Package	Single row straight 4-pins(SIP4)

Structure

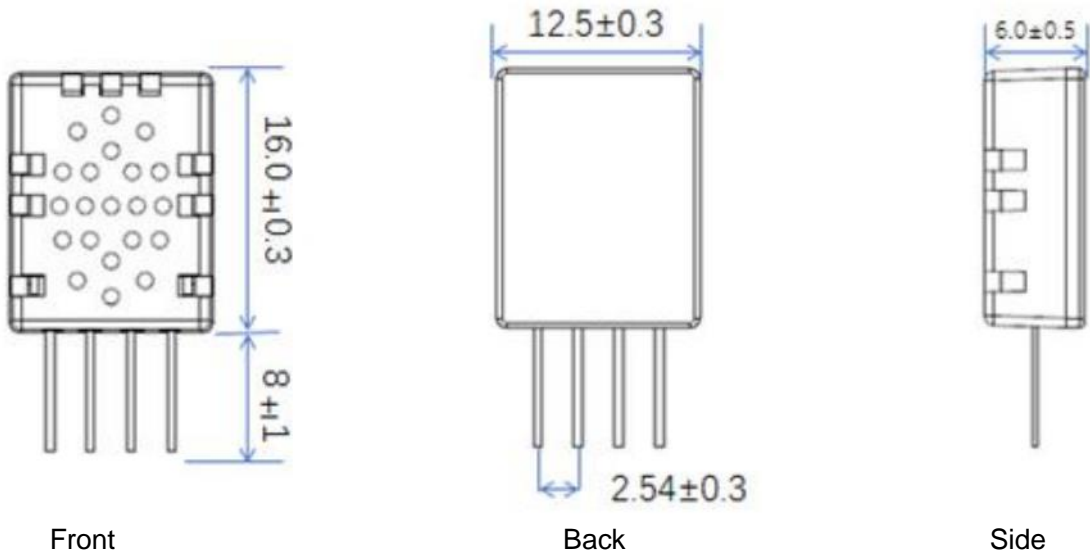
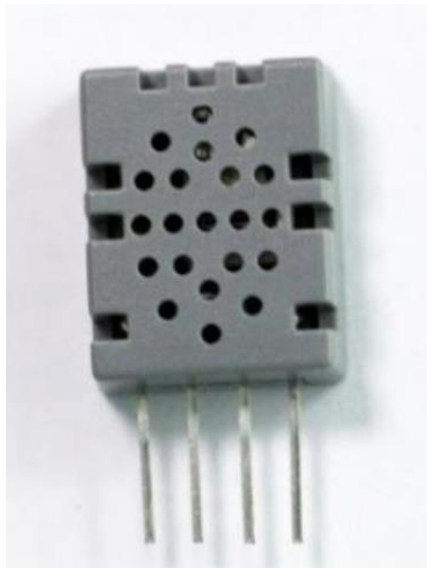

Fig1: Structure

Pins definition

1. VCC Power supply 3.3~5.5V DC
2. DATA Serial data, unibus
3. NC NULL (hang in the air)
4. GND ground, power negative



VCC DATA NC GND

Fig2. Pins

Typical circuit

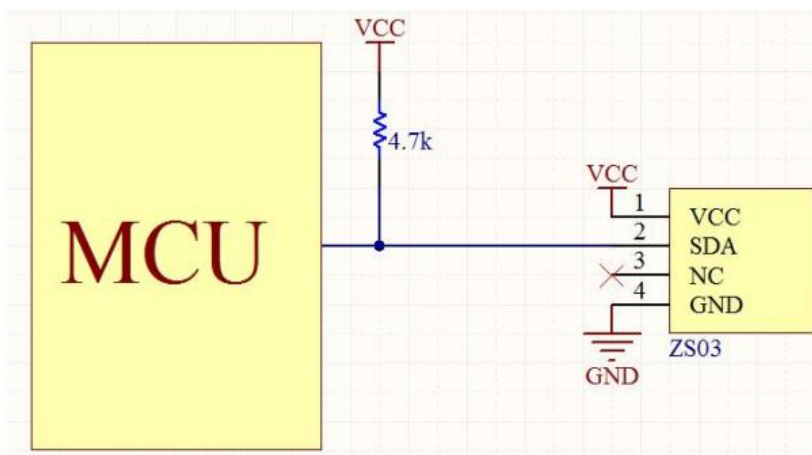

Fig3 Application circuit

Serial Port (Bidirectional Single Line)

DATA is used to communicate and synchronize between microprocessor and ZS03, it adopts unibus data format, one communication takes about 4ms, data includes fractional part and integral part, one complete data transportation has 40 bits, high bits first.

Data format: 8 bit humidity integral data+ 8 bit humidity decimal data
 +8 bit temperature integral data + 8 bit temperature decimal data
 +8 bit checksum

If data transportation is correct, checksum is equal to the end 8 bits of the value of “8 bit humidity integral data+ 8 bit humidity decimal data+8 bit temperature integral data + 8 bit temperature decimal data ”

NOTE: The decimal part of temperature and humidity is 0.

Communication Process

Idle state of bus is high level, host pull down the bus to wait ZS03’s response, the continue time must be longer than 18 ms to ensure ZS03 can detect the start signal. ZS03 receives the start signal from host, wait for the moment when the start signal ends, then send 80us low level response signal. After host sending start signal, delay waiting for 20-40us, read ZS03 ‘s response signal, after host sending start signal, to switch input mode or output high level. bus is pulled up by pull-up resistor.

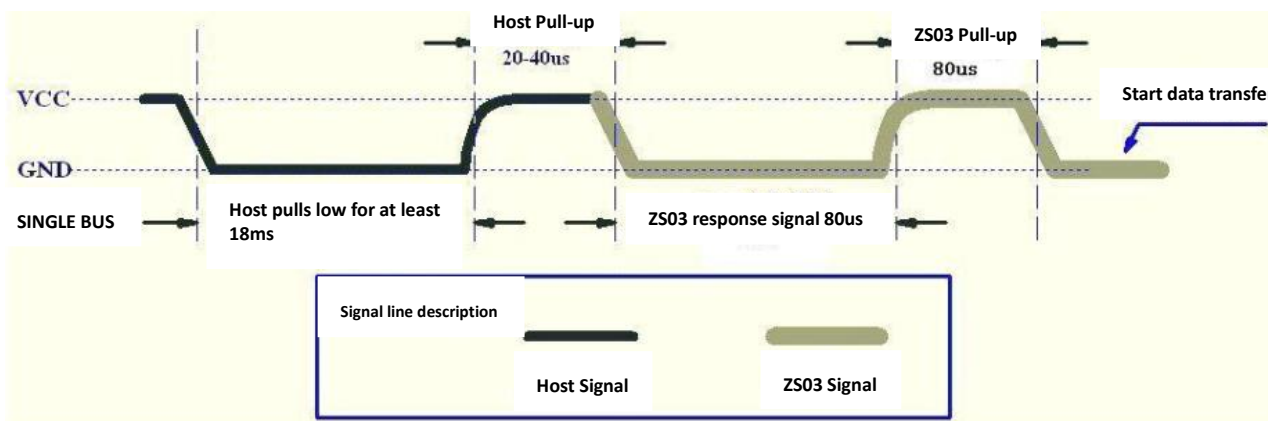

Fig4.

If bus is low level, it indicates the sensor is sending response signal, after ZS03 sending response signal,

pull up the bus high level for 80us, ready to send data, every bit data starts at 50us low level, length of high level decides the data bit is either 0 or 1.

If response signal is high level, it indicates the sensor doesn't response, please check the circuit is normal or not. After the last bit data is sent, the sensor pulls down the bus for 50us, then the bus is pulled up by pull-up resistor to idle state.

Number 0 signal is showed by Fig5.

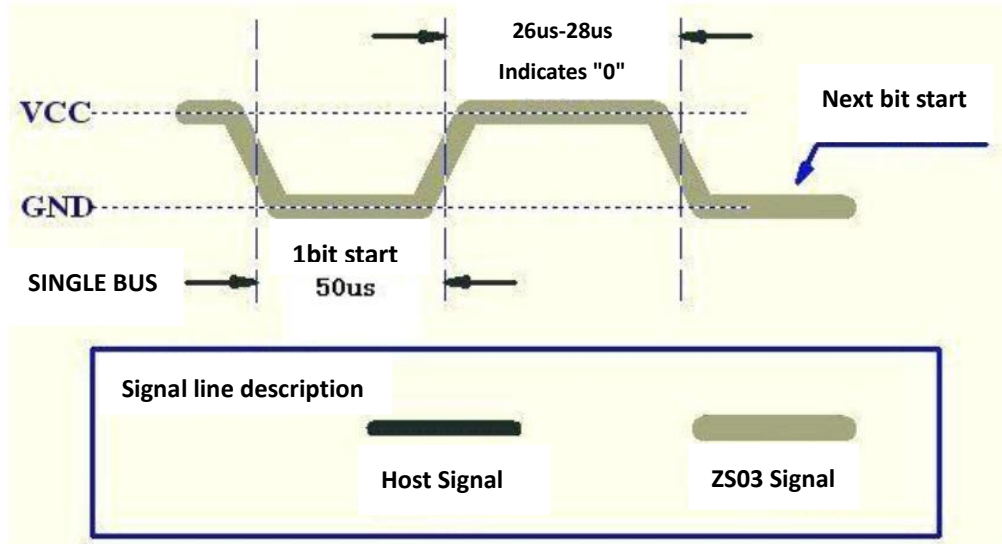

Fig5: How to show number 0 signal

Number 1 signal is showed by Fig6.

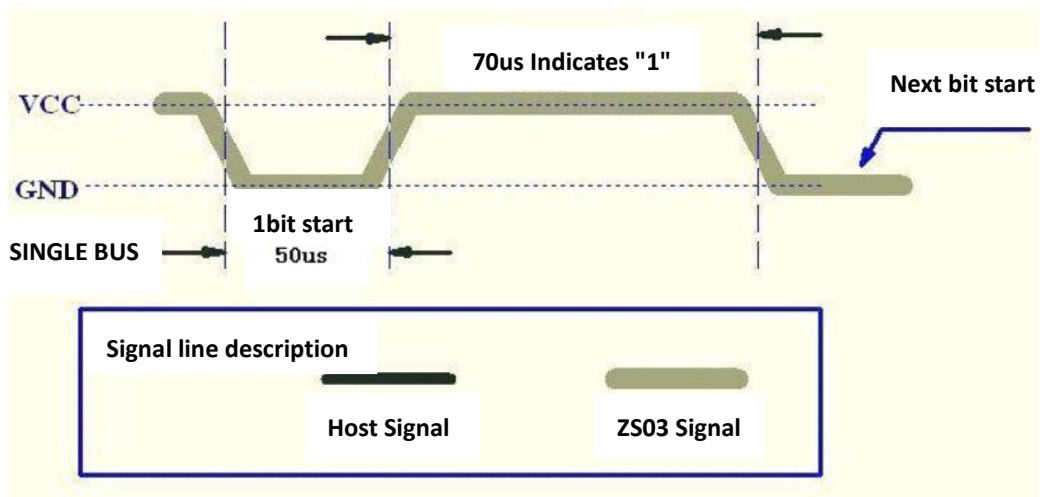

Fig6: How to show number 1 signal

Examples:

Example1: the received data of 40 bit as follow:

00110111 00000000 00010010 00000000 01001001

high 8 bits of humidity, low 8 bits of humidity, high 8 bits of temperature, low 8 bits of temperature, check bit

Determine whether the temperature is positive or negative:

Judging the highest digit of the 8-bit lower temperature, if the highest digit of the 8-bit lower temperature is "1", then the temperature is judged to be a negative value, and a minus sign is added before the value when outputting the temperature value, if the highest digit of the 8-bit lower temperature is "1" 0", the temperature is judged to be a positive value, and the temperature value is output normally.

Calculation:

$00110111 + 00000000 + 00010010 + 00000000 = 01001001$

The received data is correct:

humidity: $00110111 = 37H = 55\%RH$

temperature: $00010010 = 12H = 18^{\circ}C$

Example2: the received data of 40 bit as follow:

00101001 00000000 00000110 00000000 01000100

high 8 bits of humidity, low 8 bits of humidity, high 8 bits of temperature, low 8 bits of temperature, check bit

Determine whether the temperature is positive or negative:

Judging the highest digit of the 8-bit lower temperature, if the highest digit of the 8-bit lower temperature is "1", then the temperature is judged to be a negative value, and a minus sign is added before the value when outputting the temperature value, if the highest digit of the 8-bit lower temperature is "1" 0", the temperature is judged to be a positive value, and the temperature value is output normally.

Calculation:

$00101001 + 00000000 + 00000110 + 00000000 = 00101111$

00101111 is not equal to 01000100

The received data is not correct, give it up and receive the data again

Example3: the received data of 40 bit as follow:

00110111 00000000 00010010 10000000 11001001

high 8 bits of humidity, low 8 bits of humidity, high 8 bits of temperature, low 8 bits of temperature, check bit

Determine whether the temperature is positive or negative:

Judging the highest digit of the 8-bit lower temperature, if the highest digit of the 8-bit lower temperature is "1", then the temperature is judged to be a negative value, and a minus sign is added before the value when outputting the temperature value, if the highest digit of the 8-bit lower temperature is "1" 0", the temperature is judged to be a positive value, and the temperature value is output normally.

Calculation:

$00110111 + 00000000 + 00010010 + 10000000 = 11001001$

The received data is correct:

humidity: 00110111 = 37H = 55%RH

temperature: 00010010 = 12H = -18°C

Note: Since the water vapor below zero will exist in the form of ice crystals, only the temperature can be tested when the temperature is below zero, and the humidity data is inaccurate.

Suggestions for application

1.If connecting cable length is shorter than 20 meters, 4.7K pull-up resistor is necessary; if it is longer than 20 meters, the pull-up resistor should be reduced according to the actual situation.

2. When using 3.3V voltage power supply, cable length is recommended not longer than 100CM, otherwise it may cause that the sensor power supply is insufficient, resulting in measurement bias.

3. Each readout temperature and humidity value is the result of the last measurement, to obtain real-time data, users need to read twice, but several times is not recommended.

While reading the sensor, you could get accurate data if the interval is greater than 5 seconds.

Caution

- When the module is soldered, the temperature of the case should not be higher than 150°C, and the temperature of the sensor should not exceed 120°C. For manual soldering, the contact time should be less than 10 seconds at the highest temperature of 260°C.
- Temperature affects the relative humidity of gas, so when measuring humidity, the humidity sensor should work at the same temperature as much as possible. If sharing a printed circuit board with electronic components that emit heat, mount the sensor as far away from the electronic components as possible and under the heat source while maintaining good ventilation of the enclosure.
- Don't use it in dusty environment for long time
- Don't touch the humidity component inside
- Forbid storing the module in corrosive environment for long time.
- Recommended storage conditions: temperature 10°C~40°C, humidity is less than 60%RH
- Avoid condensation