

深圳市维拓精电科技有限公司

WTL International Limited

APPROVAL SHEET

DESCRIPTION :	HC-49/SMD Crystal			
NOMINAL FREQ.:	12.0000MHz			
WTL P/N:	WTL9M85419FO			
VERSION:	1			
DATE:	2022.10.12			
Customer	Customer P/N			
Promelectronica	/			
Customer Signature	WTL			
	Approved by: <i>Kevin Liu</i>			
	Checked by: <i>Shu Ping</i>			
	Issued by: <i>Shengbiao</i>			
REVISION HISTORY				
Revised Page	Revision Content	Date	Ref. No.	Reviser



CONTENT CATALOG

APPROVAL SHEET	P. 1
CONTENT CATALOG	P. 2
ELECTRICAL SPECIFICATIONS	P. 3
DIMENSIONS	P. 4
MARKING	P. 4
STRUCTURE ILLUSTRATION	P. 5
RELIABILITY SPECIFICATIONS	P. 6
SUGGESTED REFLOW PROFILE	P. 6
SUBSTANCES IN PRODUCT	P. 7
PACKING SPECIFICATIONS	P. 8
WTL PART NUMBER SYSTEM	P. 9

Attachment(s):

- 1.Product Specification Sheet
- 2.Electrical Testing Report
- 3.Reliability Report
- 4.ICP Test Report (SGS)

FEATURE

- Height 4.0mm, compact unit for surface mount
- Able to by means of a metal case and completely sealed high solution characteristics
- Copes with high density mounting and is the optimum for mass production



1、 ELECTRICAL SPECIFICATIONS

Hold Style	HC-49/SMD
Nominal Frequency	12.0000MHz
Modew	Fundamental / AT
Frequency Tolerance (at 25°C)	±30ppm
Frequency Stability Over Operating Temperature Characteristics	±50ppm
Operating Temperature Range	-20°C ~ +70°C
Storage Temperature Range	-55°C ~ +125°C
Shunt Capacitance (C ₀)	7.0pF Max
Driver Level (Typical)	100μW
Load Capacitance(C _L)	20pF
ESR	50Ω Max
Insulation Resistance	More than 500Mohms at DC100V
Aging @25°C 1 st year (Max)	±5ppm/year

REMARK: SPECIFICATIONS SUBJECT TO CHANGE WITHOUT PRIOR NOTICE. PLEASE CONFIRM WITH OUR SALES ENGINEER.

2、DIMENSIONS (Unit: mm)

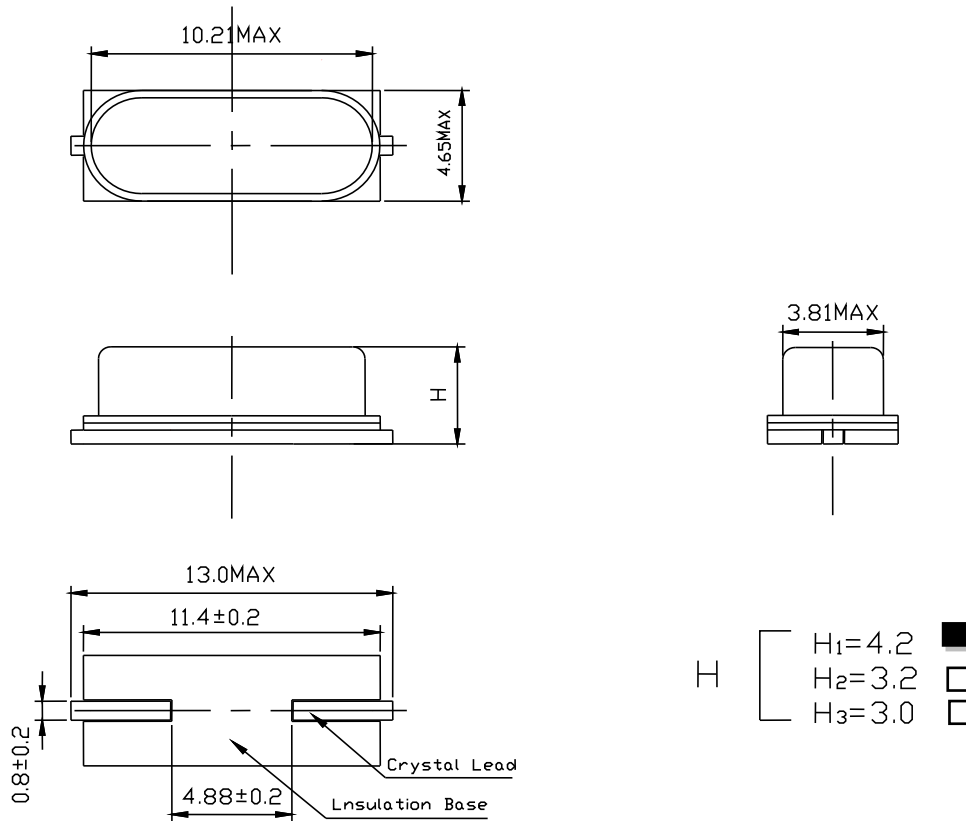

3、MARKING

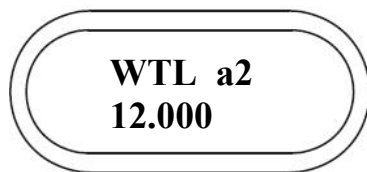

- WTL → Brand Logo
- 12.000 → Frequency (MHz)
- a → Week (a、b、c...z、A、B、C...Y、Z ,from 1 to 52week)
- 2 → YEAR (0=2020year, 1=2021year,2=2022year....)

Marking Instruction :

The date code was marked on the crystal body, which will be easily traced back in case of quality issue.

4、STRUCTURE ILLUSTRATION

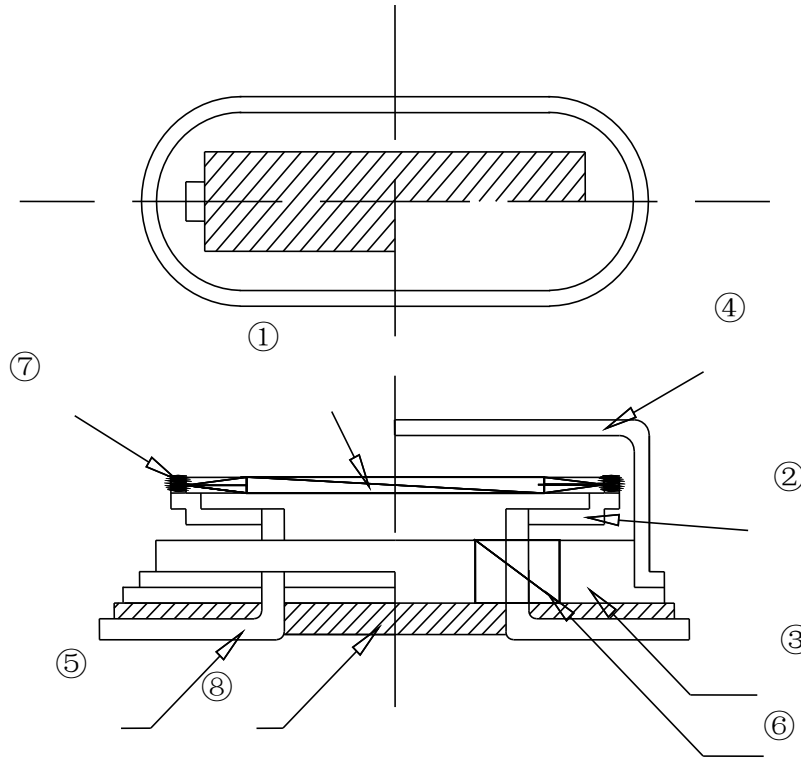

NO	COMPONENT	MATERIALS	QTY	SURFACE
①	CRYSTAL BLANK	SiO ₂	1	POLISH/ETCHED
②	SUPPORTER	COPPER	2	
③	BASE	Fe-NI	1	NI PLATED
④	CAN	NICKEL-COPPER	1	
⑤	LEAD	KOVAR	2	NI PLATED+SOLDER DIPPED
⑥	GLASS	KOVER-GLASS	2	
⑦	ADHESIVE GENT	Ag-URETHANE	2	
⑧	INSULATOR	PPS	1	

5、RELIABILITY SPECIFICATIONS

Item	Conditions	Result
Low Temp. Storage	Put the crystal into the $-40^{\circ}\text{C} \pm 2^{\circ}\text{C}$ constant temperature box for 500 ± 2 H , Measurement taken after 2 hour.	$\Delta F \cong \pm 5$ PPM $\Delta RR \cong \pm 15\%$ or 5 ohms
High Temp. Storage	Put the crystal into the $+100^{\circ}\text{C} \pm 2^{\circ}\text{C}$ constant temperature box for 500 ± 2 H, Measurement taken after 2 hour.	$\Delta F \cong \pm 5$ PPM $\Delta RR \cong \pm 15\%$ or 5 ohms
High Temp & Humidity	Put the crystal into the constant temperature & humid with the temperatures $85^{\circ}\text{C} \pm 3^{\circ}\text{C}$ and the humidity 98% for 500 ± 2 H. Measurement taken after 2 hour.	$\Delta F \cong \pm 5$ PPM $\Delta RR \cong \pm 15\%$ or 5 ohms
Thermal Shock	Put the crystal into the constant temperature $-55^{\circ}\text{C} \pm 2^{\circ}\text{C}$ for 30 ± 1 M, then change the temperature to $+85^{\circ}\text{C} \pm 2^{\circ}\text{C}$ for 30 ± 1 M, the total is 100times. Measurement taken after 2 hour.	$\Delta F \cong \pm 5$ PPM $\Delta RR \cong \pm 15\%$ or 5 ohms
Resistance To Soldering Heat	Passed through the re-flow oven under the following condition. Preheat to $150^{\circ}\text{C} \pm 5^{\circ}\text{C}$ for 60 to 120 sec, and peak $265^{\circ}\text{C} \pm 5^{\circ}\text{C}$ for $10 \text{s} \pm 3 \text{sec}$. Measurement taken after DUT being left at room temperature for at 24 ± 2 hours	$\Delta F \cong \pm 5$ PPM $\Delta RR \cong \pm 15\%$ or 5 ohms
Drop Test	The crystal fall off the cement floor with the height $75 \text{cm} \pm 5 \text{cm}$ for 3 times . Measurement taken after 2 hour.	$\Delta F \cong \pm 5$ PPM $\Delta RR \cong \pm 15\%$ or 5 ohms
Vibration Test	Apply 0.75mm vibration at sweep frequency $10 \sim 500$ Hz, for 2h. 10 cycles in each direction of 3 axis. Measurement taken after 2 hour.	$\Delta F \cong \pm 5$ PPM $\Delta RR \cong \pm 15\%$ or 5 ohms
Fine Leak	Take measurements with a helium leakage detector, or measure insulation resistance under pressure.	$1 \times 10^{-2} \mu\text{Pa} \cdot \text{m}^3 / \text{s}$ Max or $IR \geq 500 \text{M}\Omega$
Solder ability	In $245 \pm 5^{\circ}\text{C}$ solder bath for 2 ± 0.5 seconds. 8-12X magnifier.	Terminals shall be covered more then 95% with solder.

6、SUGGESTED REFLOW PROFILE

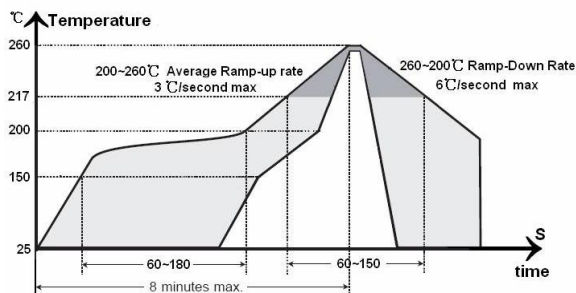

Peak temperature $260^{\circ}\text{C} \pm 5^{\circ}\text{C}$ (10sec. max)

7、SUBSTANCES IN PRODUCT

Drawing number	Disassembly Unit/component description	Homogeneous Material Name.	Substance Name	CAS No.	Substance Mass. (mg)	Content Rate(%)per
HC-49/SMD	BASE	Fe-NI	Fe	7439-89-6	290.9292	99.76%
			C	7440-44-0	0.1458	0.05%
			Mn	7439-96-5	0.4958	0.17%
			P	7723-14-0	0.035	0.01%
			Si	7440-21-3	0.0292	0.01%
	WIRE	Kovar ring	Fe	7439-89-6	12.9626	37.38%
			Cobal	7440-48-4	5.5091	15.89%
			Nickel	7440-02-0	4.5369	13.08%
			Copper	7440-50-8	10.3701	29.91%
			Sn	7440-31-5	0.6481	1.87%
			Ag	7440-22-4	0.6481	1.87%
	GLASS	GLASS	SiO2	15468-32-3	27.083	70.00%
			Al2O3	1344-28-1	3.4821	9.00%
			B2O3	1303-86-2	3.0952	8.00%
			Li2O	12057-24-8	0.4643	1.20%
			Na2O	1313-59-3	3.869	10.00%
			K2O	12136-45-7	0.5804	1.50%
	CAN	Kovar	Copper	7440-50-8	97.8194	64.26%
			Zn	7440-66-6	28.3137	18.60%
			Nickel	7440-02-0	25.9543	17.05%
			Fe	7439-89-6	0.137	0.09%
	Crystal Blank	Quartz	SiO2	14464-46-1	4.3658	100.00%
	Electrode	Ag	Ag	7440-22-4	0.3122	100.00%
	Sliver adhesive	Sliver adhesive	Ag	7440-22-4	3	75.00%
			Xylene	1330-20-7	0.4	10.00%
			C6H12O3	111-15-9	0.152	3.80%
			Isophorone	78-59-1	0.448	11.20%
	INSULATOR	INSULATOR	Poly	25212-74-2	10.40	40.00%
			Glass Fiber	65997-17-3	10.40	40.00%
			Filler	11097-59-9	4.42	17.00%
			Carbon Black	1333-86-4	0.78	3.00%

All the products we provide meet the requirements of RoHS and Reach regulations, and we send SGS for ICP test every year.

8、PACKING SPECIFICATIONS (Unit: mm)

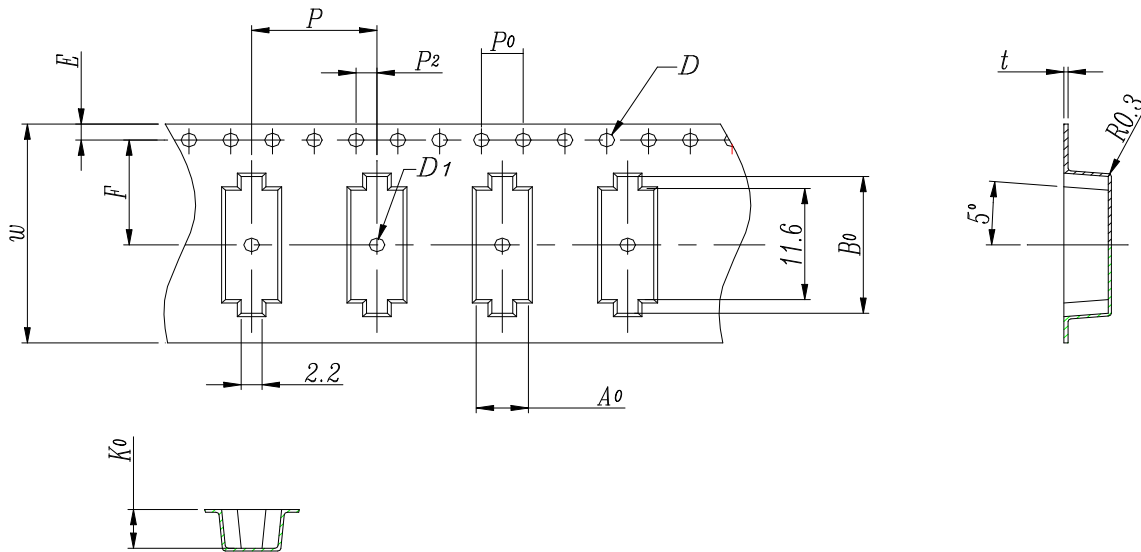

Item	W	A0	B0	K0	E	F	P	P0	P2	D	D1	t
DIM	24±0.3	4.6±0.1	14.3±0.1	4.25±0.1	1.75±0.1	11.5±0.1	12.0±0.1	4.0±0.1	2.0±0.1	±1.5	±1.5	5.0±0.1

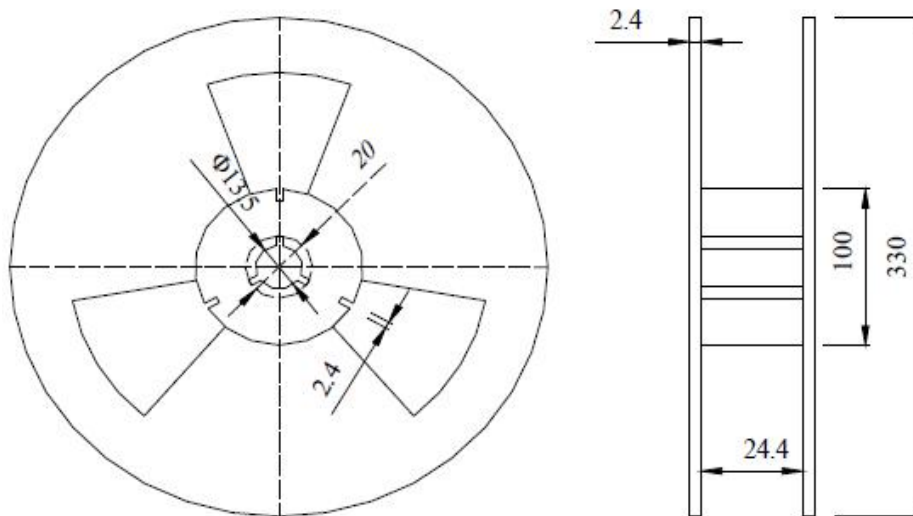

*1000pcs/Reel

9、WTL PART NUMBER SYSTEM :

For example: WTL9M85419FO

[Instructions: for project management, WTL will trace back the part number to developer wherever it goes]

WTL - 9M - 85419 - FO

WTL: Brand

9M : Package Code

85419: Serial number , flow code , without any rules

FO: WTL Developer Code, for example: VH,CH,PZ,RZ,ML