

Dual Switching Diode

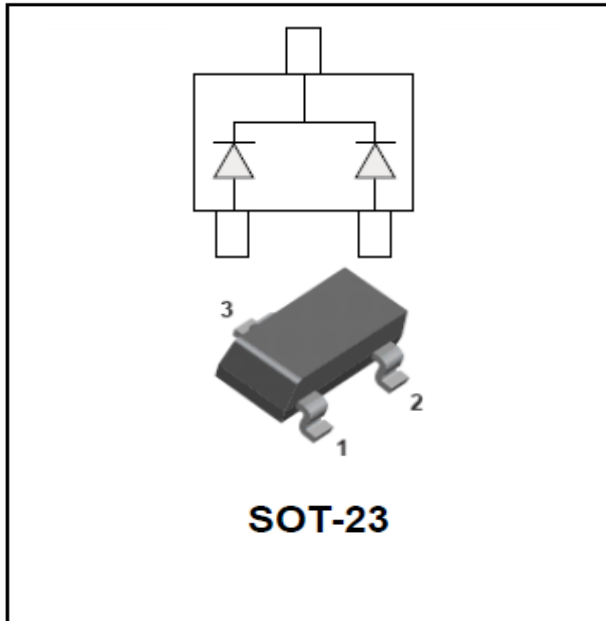

Features

- Epoxy meets UL-94 V-0 flammability rating
- Moisture Sensitivity Level 1
- Fast switching speed
- High Conductance
- Surface mount package ideally Suited for Automatic Insertion

Mechanical Data

- **Package:** SOT-23
- **Terminals:** Tin plated leads, solderable per J-STD-002 and JESD22-B102
- **Polarity:** Cathode line denotes the cathode end
- **Marking:** A4

■ Maximum Rating, ($T_a=25^\circ\text{C}$ Unless otherwise specified)

Item	Symbol	Unit	Value
Peak Reverse Voltage	V_{RRM}	V	100
Reverse Voltage	V_R	V	75
Forward Continuous Current@ $f>=50\text{Hz}$, Per Leg	I_F	mA	150
Non-Repetitive Peak Forward Surge Current@8.3ms, Half sine-wave, Per Leg	I_{FSM}	A	2.0
Power Dissipation	P_D	mW	350
Maximum Thermal Resistance	$R_{\theta JA}$	$^\circ\text{C/W}$	357
Storage Temperature	T_{STG}	$^\circ\text{C}$	-55 to +150
Operating Junction Temperature	T_j	$^\circ\text{C}$	-55 to +150

■ Ordering Information (Example)

PREFERRED P/N	PACKING CODE	UNIT WEIGHT(g)	MINIMUM PACKAGE(pcs)	INNER BOX QUANTITY(pcs)	OUTER CARTON QUANTITY(pcs)	DELIVERY MODE
BAV70	F2	Approximate 0.008	3000	30000	120000	7" reel



BAV70

■ Electrical Characteristics (T_a=25°C Unless otherwise specified, Per Leg)

Item	Symbol	Unit	Conditions	Value
Reverse Voltage	V _R	V	I _R =2.5μA	75
Maximum Instantaneous Forward Voltage	V _F	V	I _{FM} =10mA	1
Maximum DC Reverse Current	I _R	μA	V _R =75V	2.5
Typical Junction Capacitance	C _J	pF	f=1.0MHz, V _R =0V	4
Reverse Recovery Time	T _{rr}	ns	I _F =10mA, V _R =6V, R _L =100Ω, I _{rr} =1mA	4

■ Typical Characteristics (Per Leg)

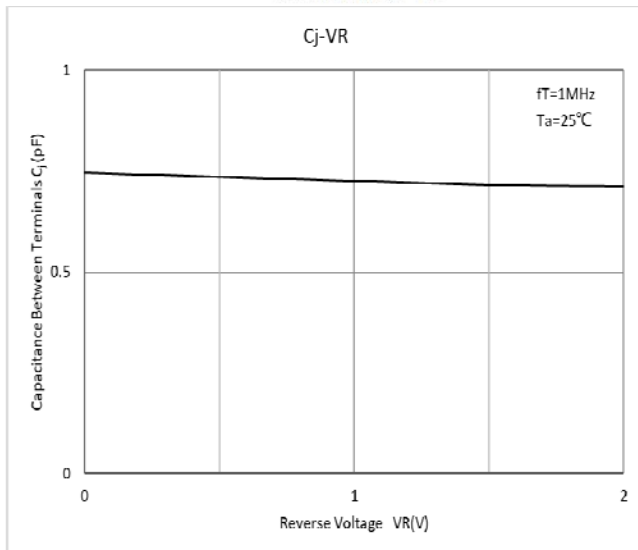
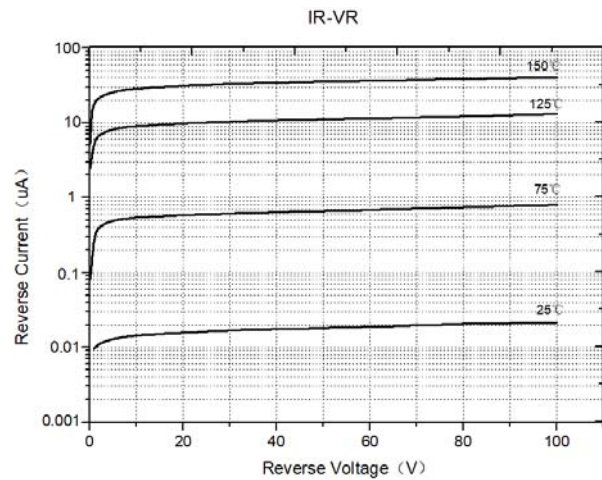
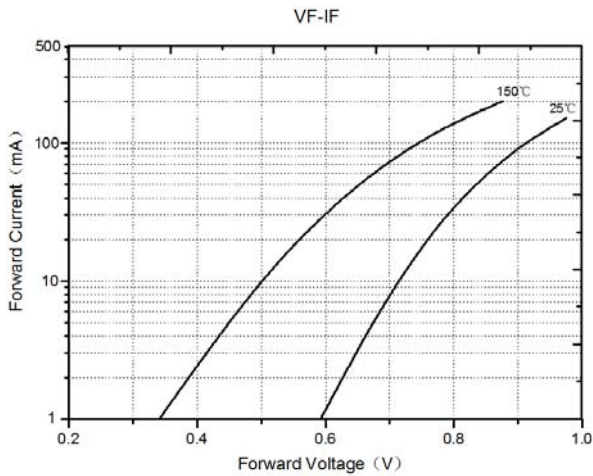



BAV70

■SOT-23 Package Outline Dimensions

SOT-23

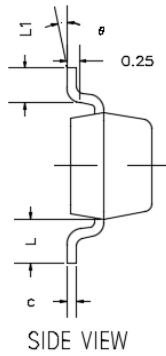
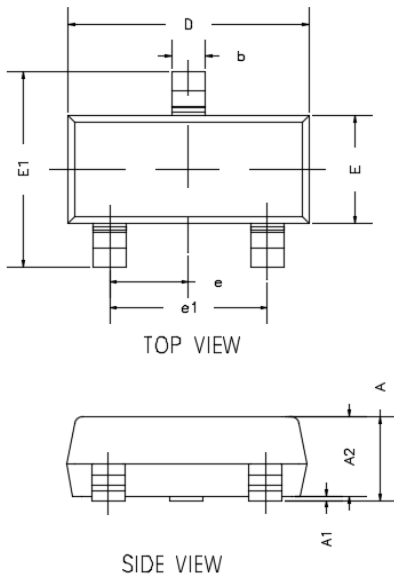

DIMENSIONS				
DIM	INCHES		MM	
	MIN	MAX	MIN	MAX
A	0.035	0.045	0.900	1.150
A1	0.000	0.004	0.000	0.100
A2	0.035	0.041	0.900	1.050
b	0.012	0.020	0.300	0.500
c	0.004	0.008	0.100	0.200
D	0.110	0.118	2.800	3.000
E	0.047	0.055	1.200	1.400
E1	0.089	0.100	2.250	2.550
e	0.037TYP		0.95TYP	
e1	0.071	0.079	1.800	2.000
L	0.022TYP		0.55TYP	
L1	0.012	0.020	0.300	0.500
θ	0°	8°	0°	8°

■SOT-23 Suggested Pad Layout

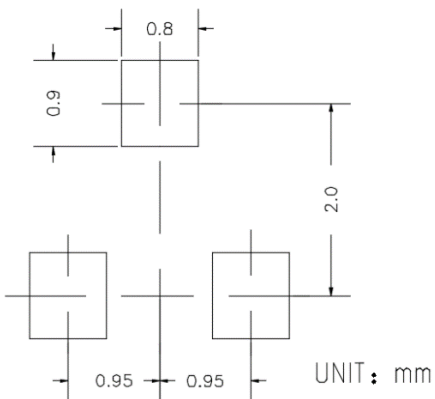

SUGGESTED SOLDER PAD LAYOUT



BAV70

Disclaimer

The information presented in this document is for reference only. Yangzhou Yangjie Electronic Technology Co., Ltd. reserves the right to make changes without notice for the specification of the products displayed herein to improve reliability, function or design or otherwise.

The product listed herein is designed to be used with ordinary electronic equipment or devices, and not designed to be used with equipment or devices which require high level of reliability and the malfunction of which would directly endanger human life (such as medical instruments, transportation equipment, aerospace machinery, nuclear-reactor controllers, fuel controllers and other safety devices), Yangjie or anyone on its behalf, assumes no responsibility or liability for any damages resulting from such improper use of sale.

This publication supersedes & replaces all information previously supplied. For additional information, please visit our website [http:// www.21yangjie.com](http://www.21yangjie.com) , or consult your nearest Yangjie's sales office for further assistance.