



Rectifier Diode Modules

V_{RRM} 800 to 1800V

I_{FAV} 350 A

Applications

- Non-controllable rectifiers for AC/AC converters
- Line rectifiers for transistorized AC motor controllers
- Field supply for DC motors

Features

- Blocking voltage: 800 to 1800V
- Heat transfer through aluminum oxide ceramic isolated metal baseplate

Circuit

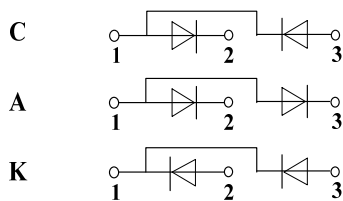

Module Type

TYPE			V _{RRM}	V _{RSM}
MD350C08D4	MD350A08D4	MD350K08D4	800V	900V
MD350C12D4	MD350A12D4	MD350K12D4	1200V	1300V
MD350C16D4	MD350A16D4	MD350K16D4	1600V	1700V
MD350C18D4	MD350A18D4	MD350K18D4	1800V	1900V

Maximum Ratings

Symbol	Conditions	Values	Units
I _{FAV}	Single phase ,half wave 180° conduction T _c =85°C	350	A
I _{FSM}	t=10mS T _{vj} =45°C	13000	A
i ² t	t=10mS T _{vj} =45°C	845000	A ² s
V _{isol}	a.c.50HZ;r.m.s.;1min	3000	V
T _{vj}		-40 to 150	°C
T _{stg}		-40 to 125	°C
M _t	To terminals(M10)	9±15%	Nm
M _s	To heatsink(M6)	5±15%	Nm
Weight	Module (Approximately)	1509	g

Thermal Characteristics

Symbol	Conditions	Values	Units
R _{th(j-c)}	Per diode	0.05	°C/W
R _{th(c-s)}	Module	0.02	°C/W

Electrical Characteristics

Symbol	Conditions	Values			Units
		Min.	Typ.	Max.	
V _{FM}	T=25°C I _F =1200A	—	—	1.8	V
I _{RD}	T _{vj} =T _{vjM} V _{RD} =V _{RRM}	—	—	20	mA

Performance Curves

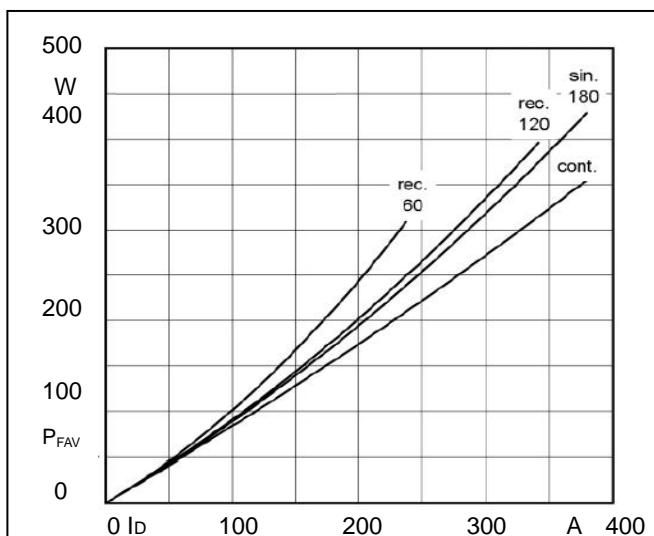

Fig1. Power dissipation

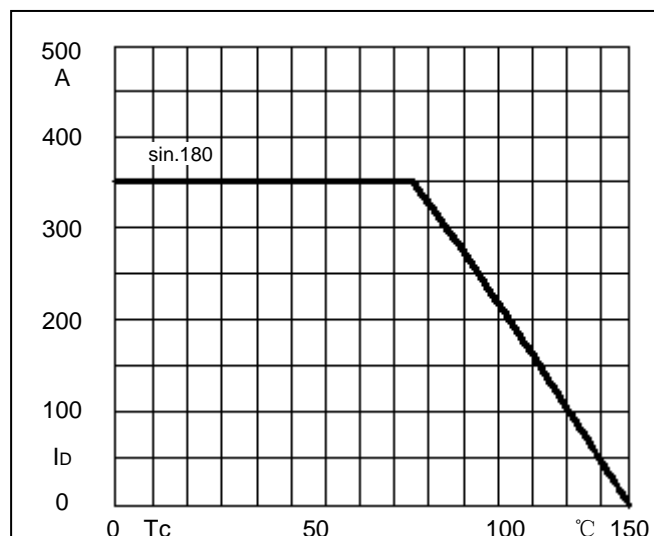

Fig2. Forward Current Derating Curve

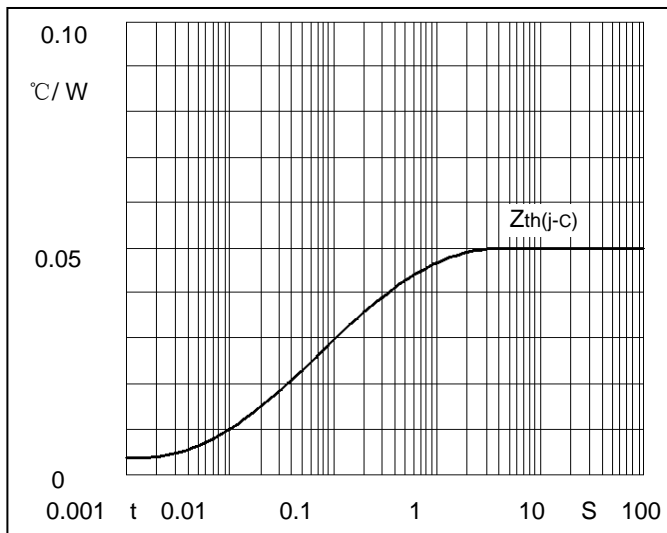

Fig3. Transient thermal impedance

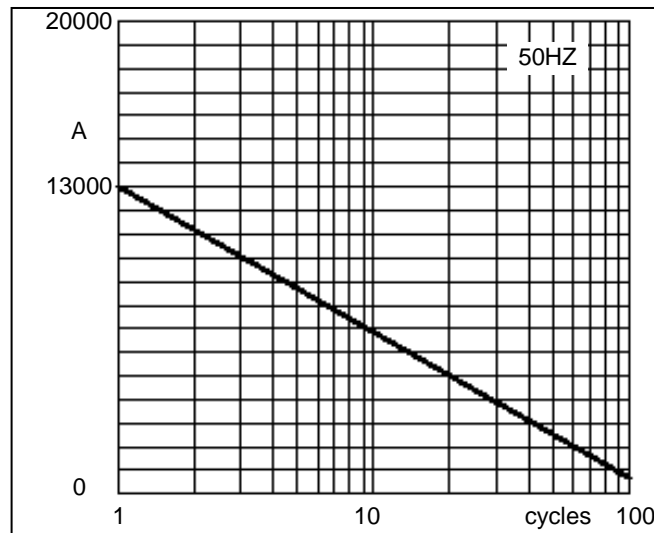

Fig4. Max Non-Repetitive Forward Surge Current

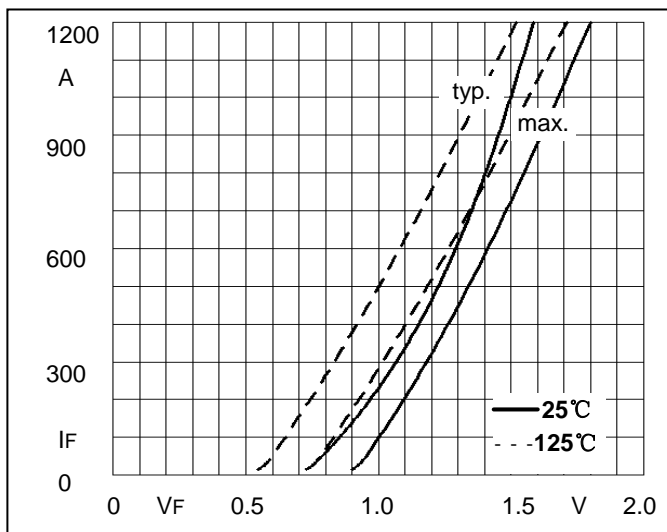
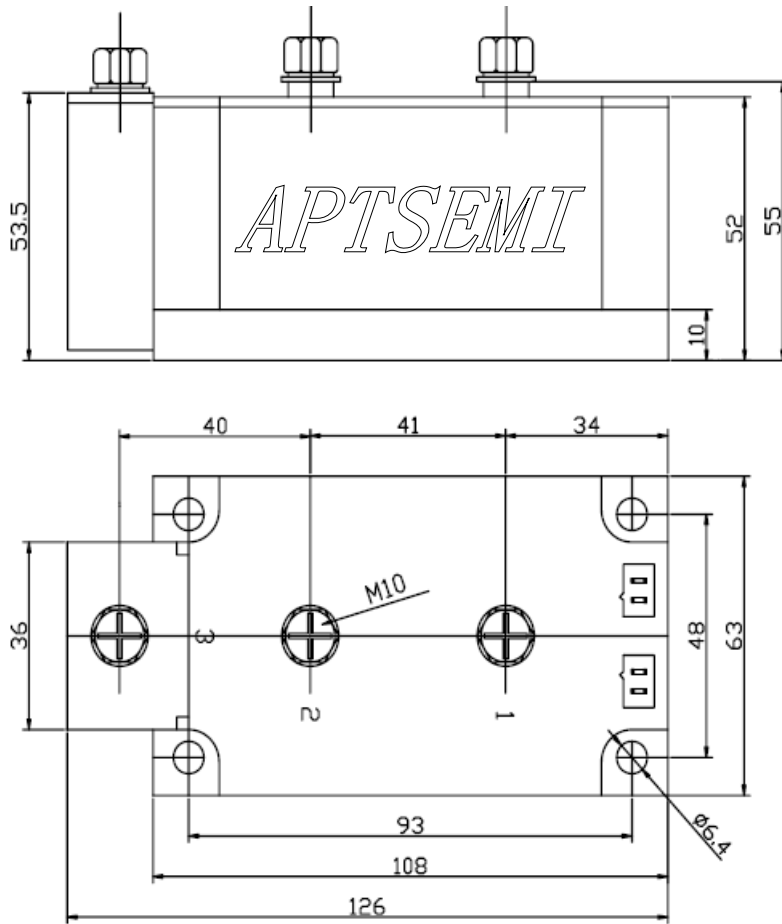

Fig5. Forward Characteristics

Package Outline Information

CASE: D4



Dimensions in mm