



## FRED Modules

**V<sub>RRM</sub>** 600V  
**I<sub>FAV</sub>** 2×100 A

### Applications

- Inversion Welder
- Uninterruptible Power Supply (UPS)
- Plating Power Supply
- Ultrasonic Cleaner and Welder
- Power Factor Correction (PFC) Circuit
- Converter & Chopper

### Features

- Soft Reverse Recovery Characteristics
- Ultrafast Reverse Recovery Time
- Low Reverse Recovery Loss
- Low Forward Voltage
- High Surge Current Capability
- Popular SOT-227 Package

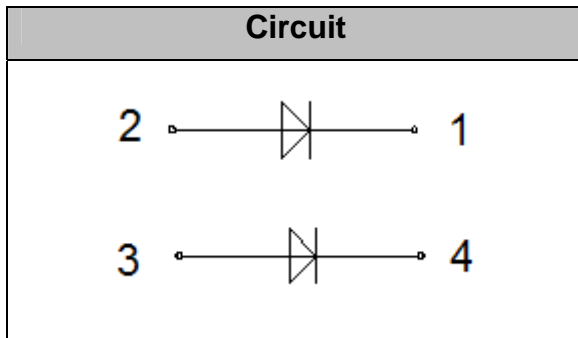

## Maximum Ratings

Symbol	Conditions	Values	Units
V <sub>R</sub>		600	V
V <sub>RRM</sub>		600	V
I <sub>F(AV)</sub>	T <sub>C</sub> =90°C, Per Leg	100	A
	T <sub>C</sub> =90°C, Per Module	200	A
I <sub>F(RMS)</sub>	T <sub>C</sub> =90°C, Per Leg	150	A
I <sub>FSM</sub>	1/2 Cycle, 50Hz, Sine	1300	A
	1/2 Cycle, 60Hz, Sine	1500	A
I <sup>2</sup> t	T <sub>J</sub> =45°C, t=10ms, 50Hz, Sine	8450	A <sup>2</sup> s
P <sub>D</sub>	T <sub>C</sub> =25°C	260	W
T <sub>J</sub>		-40 to +150	°C
T <sub>STG</sub>		-40 to +125	°C
Visol	3600V AC 1s	1	mA
Torque	To Sink Recommended (M4)	0.6~1.2	N·m
Torque	To Terminal Recommended (M4)	0.6~1	N·m
Weight		27	g

## Thermal Characteristics

Symbol	Conditions	Values	Units
R <sub>th(j-c)</sub>	Per diode	0.3	°C/W



**Electrical Characteristics**

Symbol	Conditions	Values			Units
		Min.	Typ.	Max.	
$I_{RM}$	$V_R=600V$	--	--	0.5	mA
	$V_R=600V, T_J=125^\circ C$	--	--	1	mA
$V_F$	$I_F=100A$	--	1.2	1.3	V
	$I_F=100A, T_J=125^\circ C$	--	1.1	1.2	V
$t_{rr}$	$I_F=1A, V_R=30V, di_F/dt=-200A/\mu s$	--	42	50	ns
$t_{rr}$	$V_R=300V, I_F=100A, di_F/dt=-200A/\mu s, T_J=25^\circ C$	--	105	--	ns
$I_{RRM}$		--	10	--	A
$t_{rr}$	$V_R=300V, I_F=100A, di_F/dt=-200A/\mu s, T_J=125^\circ C$	--	200	--	ns
$I_{RRM}$		--	18	--	A

**Performance Curves**

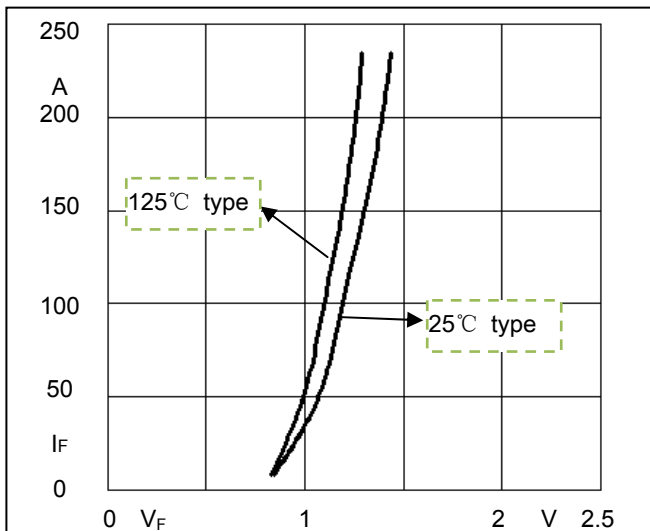

**Fig1. Forward Voltage Drop vs Forward Current**

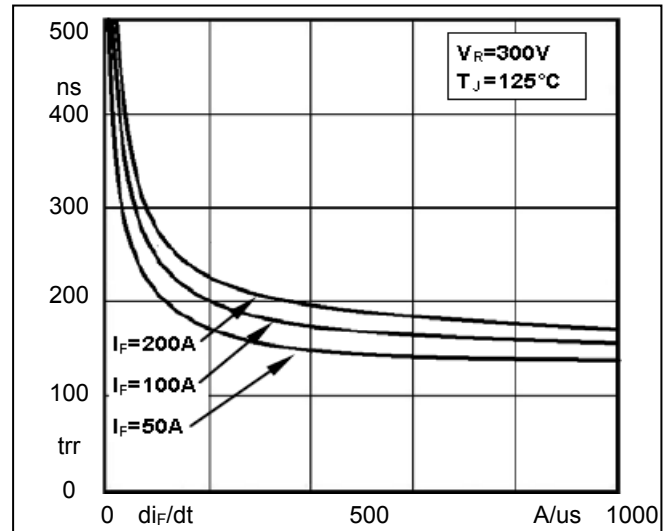

**Fig2. Reverse Recovery Time vs  $di_F/dt$**

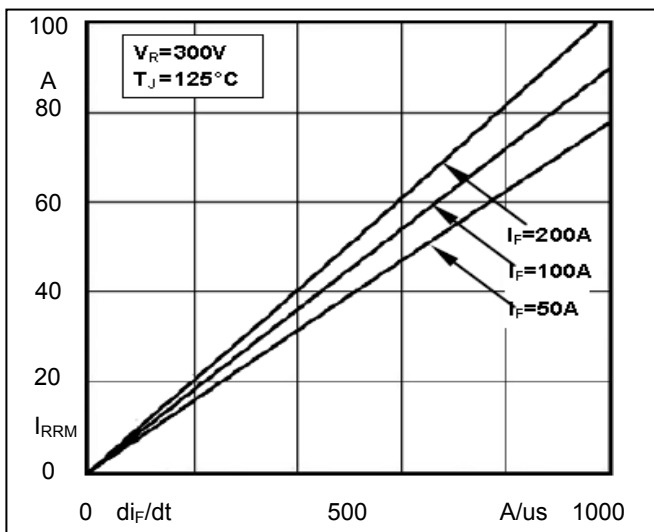

**Fig3. Reverse Recovery Current vs  $di_F/dt$**

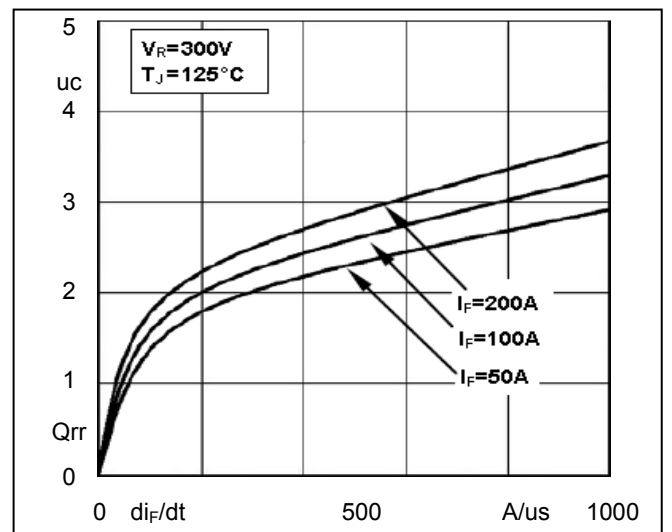

**Fig4. Reverse Recovery Charge vs  $di_F/dt$**

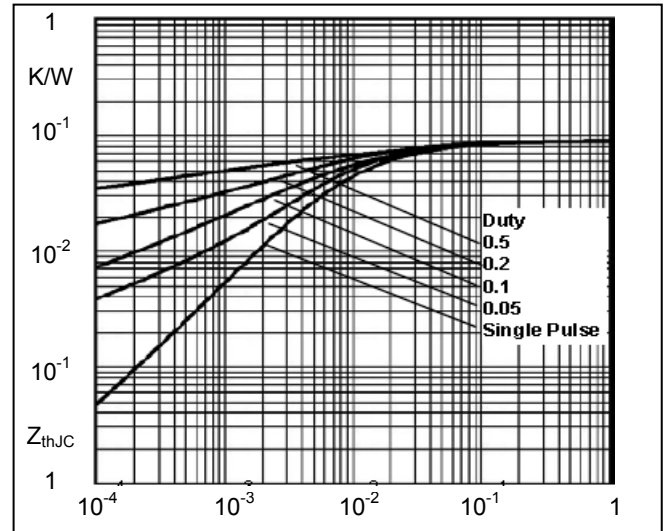
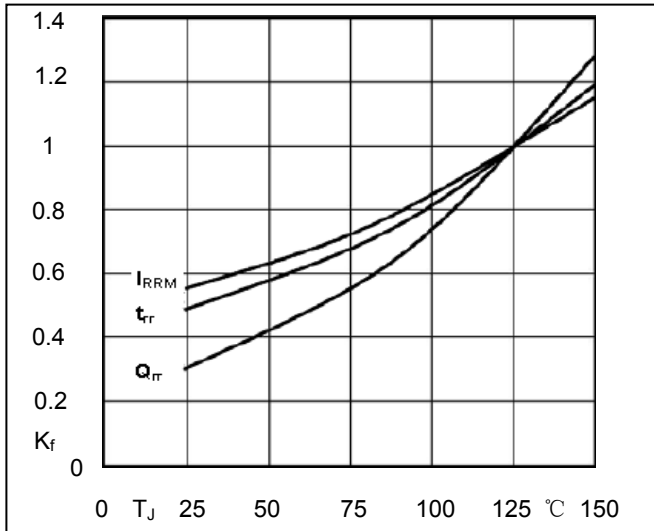

Fig5. Dynamic Parameters vs Junction Temperature

Fig6. Transient Thermal Impedance

### Package Outline Information

