



Three Phase Bridge + Thyristor

VRRM / VDRM 800 to 1800V
IFAV / ITAV 100A

Features

- Blocking voltage:800 to 1800V
- Three Phase Bridge and a Thyristor
- Isolated Module package

Applications

- Inverter for AC or DC motor control
- Current stabilized power supply
- Switching power supply
- UL recognized applied for file no. E360040

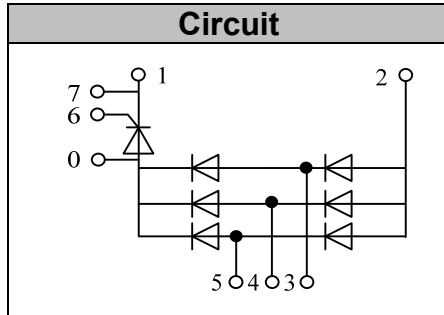

Module Type

TYPE	VRRM / VDRM	VRSM
MT100DT08L1	800V	900V
MT100DT12L1	1200V	1300V
MT100DT16L1	1600V	1700V
MT100DT18L1	1800V	1900V

◆ Diode

Maximum Ratings

Symbol	Item	Conditions	Values	Units
ID	Output Current(D.C.)	Tc=100°C Three phase full wave	100	A
IFSM	Surge forward current	t=10mS Tvj =45°C	1200	A
i²t	Circuit Fusing Consideration		7200	A²s
Visol	Isolation Breakdown Voltage(R.M.S)	a.c.50HZ;r.m.s.;1min	3000	V
Tvj	Operating Junction Temperature		-40 to +150	°C
Tstg	Storage Temperature		-40 to +125	°C
Mt	Mounting Torque	To terminals(M5)	3±15%	Nm
Ms		To heatsink(M5)	3±15%	Nm
Weight		Module (Approximately)	210	g

Thermal Characteristics

Symbol	Item	Conditions	Values	Units
Rth(j-c)	Thermal Impedance, max.	Junction to Case(TOTAL)	0.18	°C/W
Rth(c-s)	Thermal Impedance, max.	Case to Heatsink	0.10	°C/W

Electrical Characteristics

Symbol	Item	Conditions	Values	Units
VFM	Forward Voltage Drop, max.	T=25°C IF =100A	1.35	V
IRRM	Repetitive Peak Reverse Current, max.	Tvj =25°C VRD=VRRM Tvj =150°C VRD=VRRM	≤0.5 ≤6	mA mA



◆Thyristor

Maximum Ratings

Symbol	Item	Conditions	Values	Units
I_{TAV}	Average On-State Current	$T_c=92^{\circ}\text{C}$, Single Phase half wave 180° conduction	100	A
I_{TSM}	Surge On-State Current	$T_{VJ}=45^{\circ}\text{C}$ $t=10\text{ms}$ (50Hz), sine $V_R=0$	1200	A
i^2t	Circuit Fusing Consideration		7200	A^2s
Visol	Isolation Breakdown Voltage(R.M.S)	a.c.50Hz;r.m.s.;1 min	3000	V
T_{vj}	Operating Junction Temperature		-40 to +125	$^{\circ}\text{C}$
T_{stg}	Storage Temperature		-40 to +125	$^{\circ}\text{C}$
M_t	Mounting Torque	To terminals(M5)	$3\pm 15\%$	Nm
M_s		To heatsink(M5)	$3\pm 15\%$	Nm
di/dt	Critical Rate of Rise of On-State Current	$T_{VJ}=T_{VJM}$, $V_D=1/2V_{DRM}$, $I_G=100\text{mA}$ $dI_G/dt=0.1\text{A}/\mu\text{s}$	150	$\text{A}/\mu\text{s}$
dv/dt	Critical Rate of Rise of Off-State Voltage, min.	$T_J=T_{VJM}$, $V_D=2/3V_{DRM}$, linear voltage rise	500	$\text{V}/\mu\text{s}$

Electrical and Thermal Characteristics

Symbol	Item	Conditions	Values			Units
			Min.	Typ.	Max.	
V_{TM}	Peak On-State Voltage, max.	$T=25^{\circ}\text{C}$ $I_T=100\text{A}$			1.25	V
I_{RRM}/I_{DRM}	Repetitive Peak Reverse Current, max. / Repetitive Peak Off-State Current, max.	$T_{VJ}=T_{VJM}$, $V_R=V_{RRM}$, $V_D=V_{DRM}$			20	mA
V_{GT}	Gate Trigger Voltage, max.	$T_{VJ}=25^{\circ}\text{C}$, $V_D=6\text{V}$		1	3	V
I_{GT}	Gate Trigger Current, typ /max.	$T_{VJ}=25^{\circ}\text{C}$, $V_D=6\text{V}$		65	150	mA
I_H	Hoding Current, typ / max.	$T_{VJ}=25^{\circ}\text{C}$, $V_D=6\text{V}$		120	220	mA
I_L	latching Current, typ / max.	$T_{VJ}=25^{\circ}\text{C}$, $R=33\Omega$		180	400	mA
$R_{th(j-c)}$	Thermal Impedance, max.	Junction to Case			0.26	$^{\circ}\text{C}/\text{W}$
$R_{th(c-s)}$	Thermal Impedance, max.	Case to Heatsink			0.10	$^{\circ}\text{C}/\text{W}$



Performance Curves

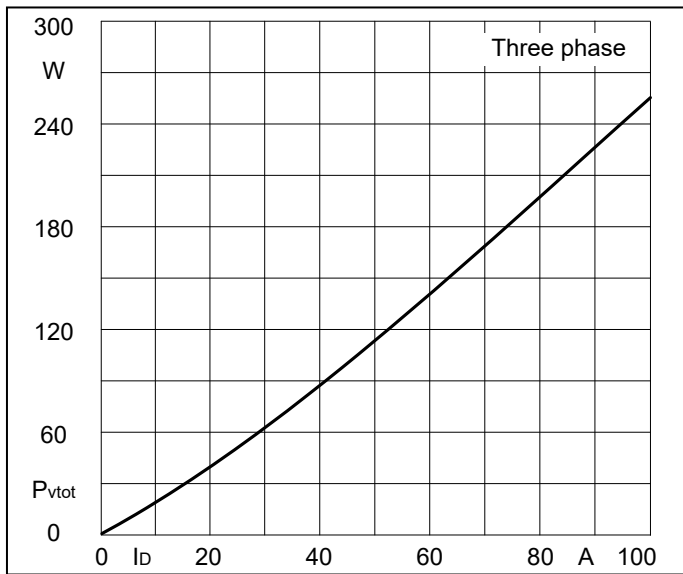

Fig1. Power dissipation

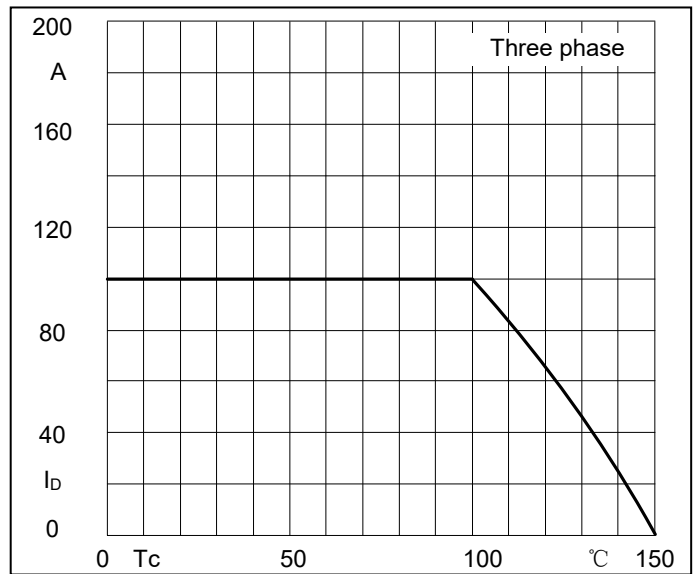

Fig2. Forward Current Derating Curve

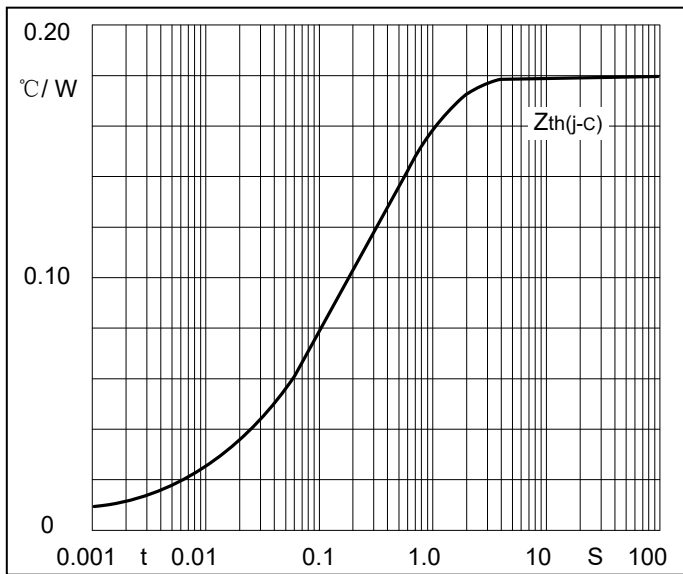

Fig3. Transient thermal impedance

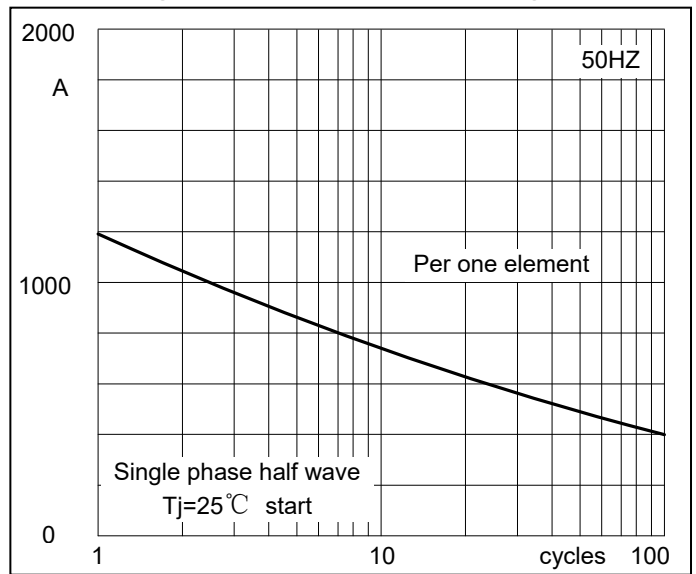

Fig4. Max Non-Repetitive Forward Surge Current

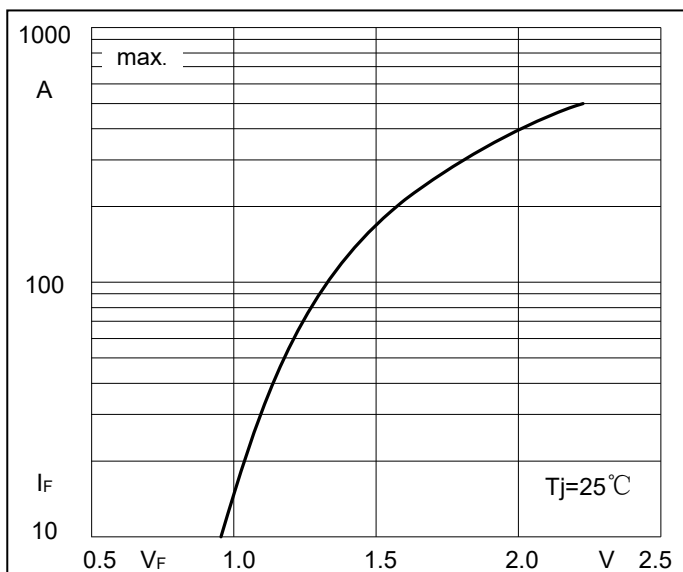

Fig5. Forward Characteristics

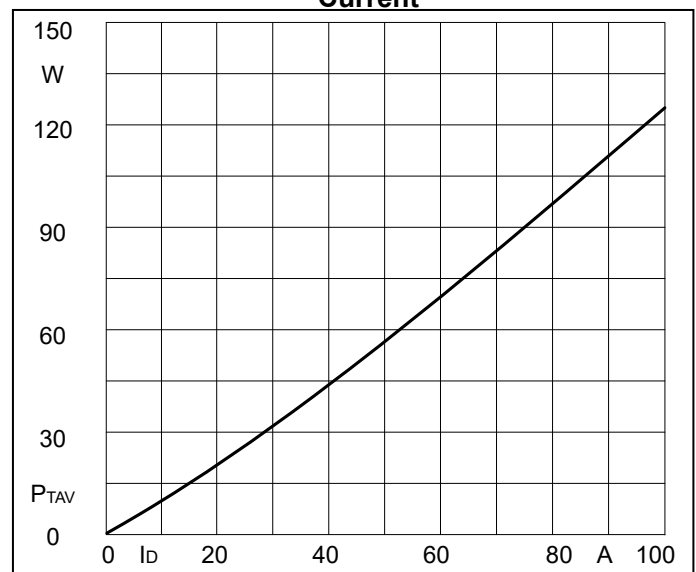

Fig6. SCR Power dissipation

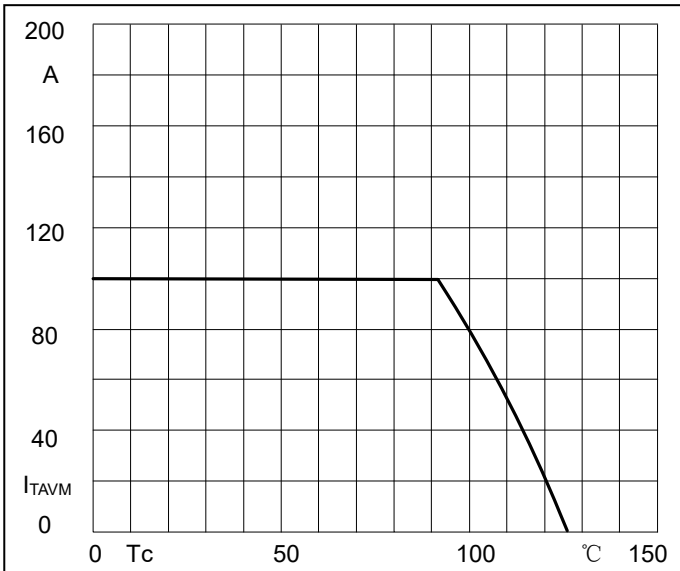

Fig7. SCR Forward Current Derating Curve

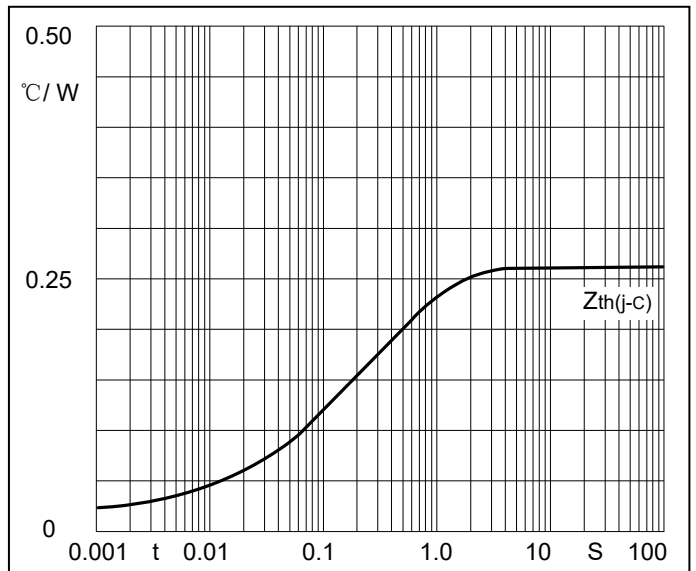

Fig8. SCR Transient thermal impedance

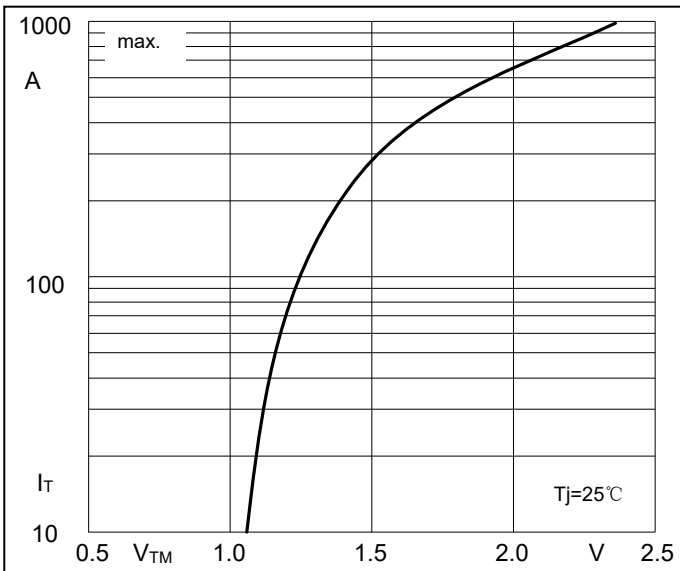

Fig9. SCR Forward Characteristics

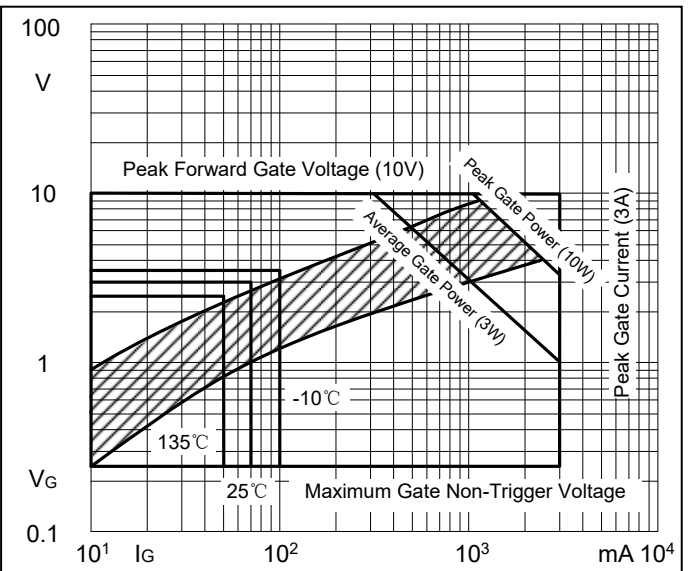

Fig10. Gate trigger Characteristics

