

Thyristor Modules



VRRM / VDRM 800 to 1800V
ITAV 40A

Applications

- Power Converters
- Lighting Control
- DC Motor Control and Drives
- Heat and temperature control

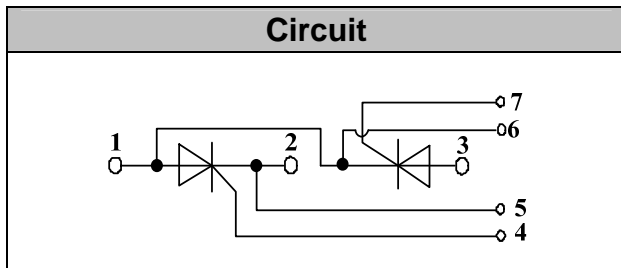

Features

- International standard package
- High Surge Capability
- Glass passivated chip
- Simple Mounting
- Heat transfer through aluminum oxide DBC ceramic isolated metal baseplate
- UL recognized applied for file no. E360040

Module Type

| TYPE | VRRM | V _{RSM} |
|-----------|-------|------------------|
| MT40C08T1 | 800V | 900V |
| MT40C12T1 | 1200V | 1300V |
| MT40C16T1 | 1600V | 1700V |
| MT40C18T1 | 1800V | 1900V |

Maximum Ratings

| Symbol | Conditions | Values | Units |
|-----------|--|--------------|------------------|
| I_{TAV} | Sine 180°; $T_c=85^\circ\text{C}$ | 40 | A |
| I_{TSM} | $T_{VJ}=45^\circ\text{C}$ t=10ms, sine | 1000 | A |
| | $T_{VJ}=125^\circ\text{C}$ t=10ms, sine | 850 | |
| i^2t | $T_{VJ}=45^\circ\text{C}$ t=10ms, sine | 5000 | A ² s |
| | $T_{VJ}=125^\circ\text{C}$ t=10ms, sine | 3600 | |
| Visol | a.c.50HZ;r.m.s.;1min | 3000 | V |
| T_{vj} | | -40 to 125 | °C |
| T_{stg} | | -40 to 125 | °C |
| Mt | To terminals(M5) | $3 \pm 15\%$ | Nm |
| Ms | To heatsink(M6) | $5 \pm 15\%$ | Nm |
| di/dt | $T_{VJ}= T_{VJM}$, $2/3V_{DRM}$, $I_G=500\text{mA}$ $Tr<0.5\mu\text{s}$, $tp>6\mu\text{s}$ | 150 | A/ μs |
| dv/dt | $T_J= T_{VJM}$, $2/3V_{DRM}$ linear voltage rise | 1000 | V/ μs |
| a | Maximum allowable acceleration | 50 | m/s ² |
| Weight | Module(Approximately) | 100 | g |

Thermal Characteristics

| Symbol | Conditions | Values | Units |
|----------|----------------------------------|-----------|-------|
| Rth(j-c) | Cont.;per thyristor / per module | 0.65/0.33 | °C/W |
| Rth(c-s) | per thyristor / per module | 0.2/0.1 | °C/W |



Electrical Characteristics

| Symbol | Conditions | Values | | | Units |
|-------------------|--|--------|------|------|------------|
| | | Min. | Typ. | Max. | |
| V_{TM} | $T=25^{\circ}C$ $I_{TM}=200A$ | | | 1.95 | V |
| I_{RRM}/I_{DRM} | $T_{VJ}=T_{VJM}$, $V_R=V_{RRM}$, $V_D=V_{DRM}$ | | | 15 | mA |
| V_{TO} | For power-loss calculations only ($T_{VJ}=125^{\circ}C$) | | | 1.0 | V |
| r_T | $T_{VJ}=T_{VJM}$ | | | 4.5 | m Ω |
| V_{GT} | $T_{VJ}=25^{\circ}C$, $V_D=6V$ | | | 2.5 | V |
| I_{GT} | $T_{VJ}=25^{\circ}C$, $V_D=6V$ | | | 150 | mA |
| V_{GD} | $T_{VJ}=125^{\circ}C$, $V_D=2/3V_{DRM}$ | | | 0.25 | V |
| I_{GD} | $T_{VJ}=125^{\circ}C$, $V_D=2/3V_{DRM}$ | | | 6 | mA |
| I_L | $T_{VJ}=25^{\circ}C$, $R_G=33\ \Omega$ | | 300 | 600 | mA |
| I_H | $T_{VJ}=25^{\circ}C$, $V_D=6V$ | | 150 | 250 | mA |
| tg δ | $T_{VJ}=25^{\circ}C$, $I_G=1A$, $di_G/dt=1A/us$ | | 1 | | us |
| tq | $T_{VJ}=T_{VJM}$ | | 80 | | us |



Performance Curves

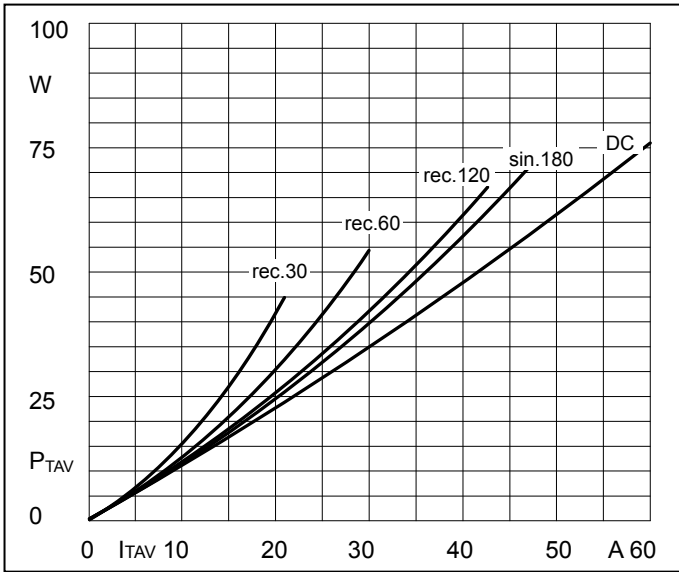

Fig1. Power dissipation

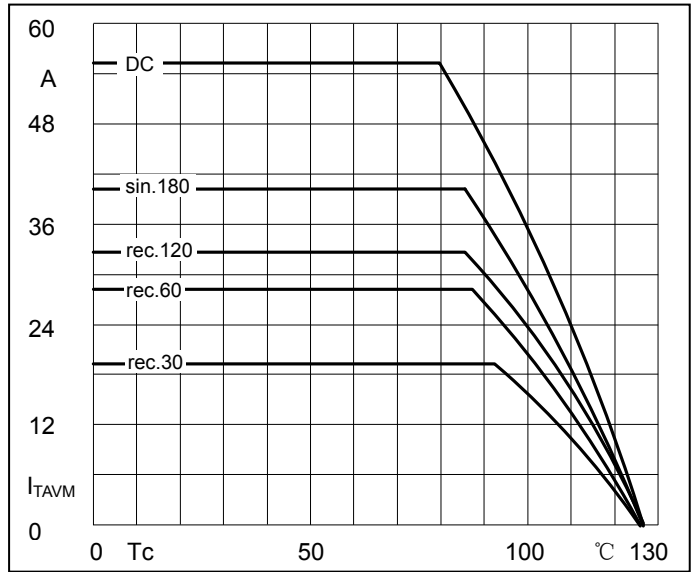

Fig2. Forward Current Derating Curve

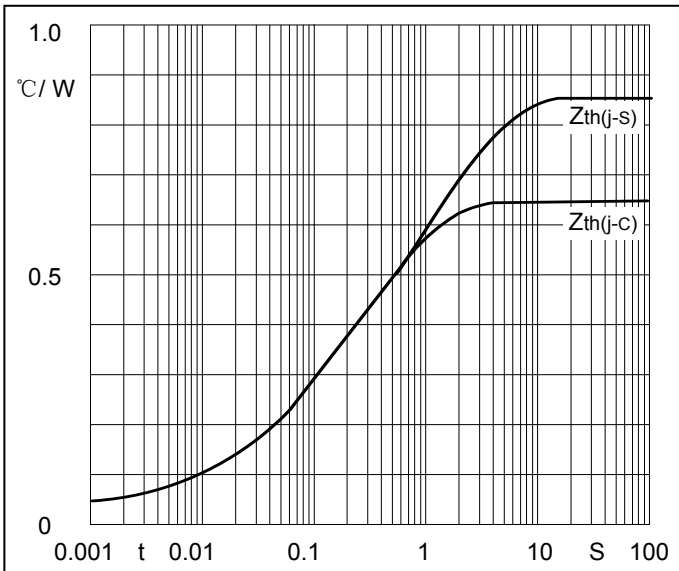

Fig3. Transient thermal impedance

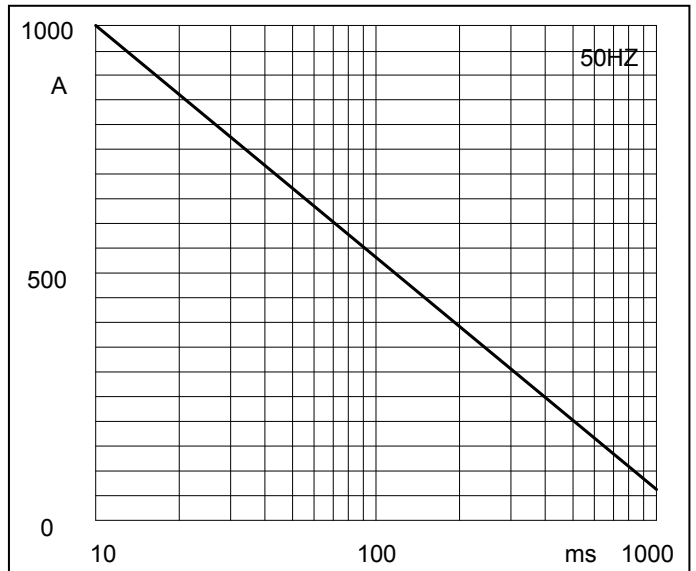

Fig4. Max Non-Repetitive Forward Surge Current

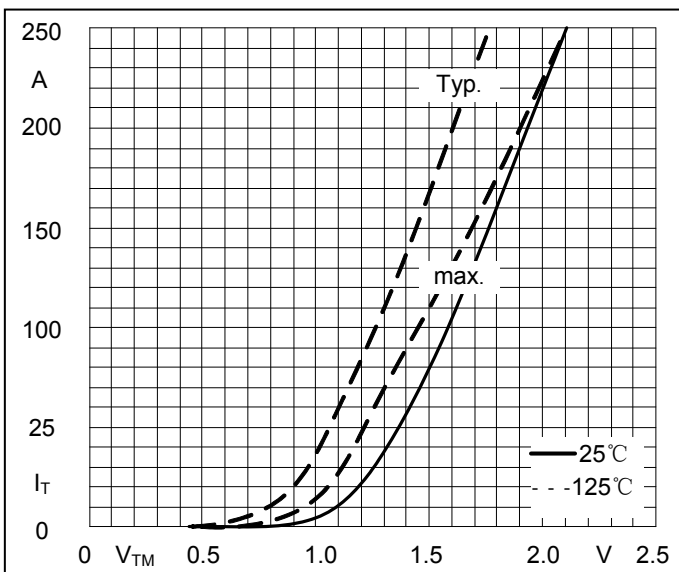

Fig5. Forward Characteristics

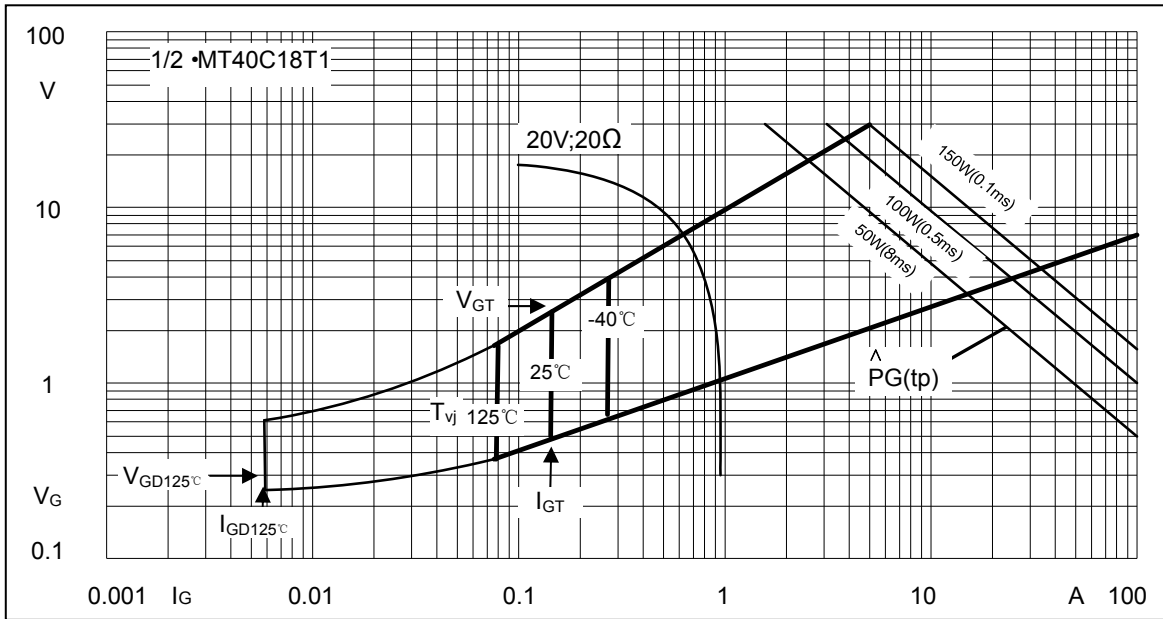
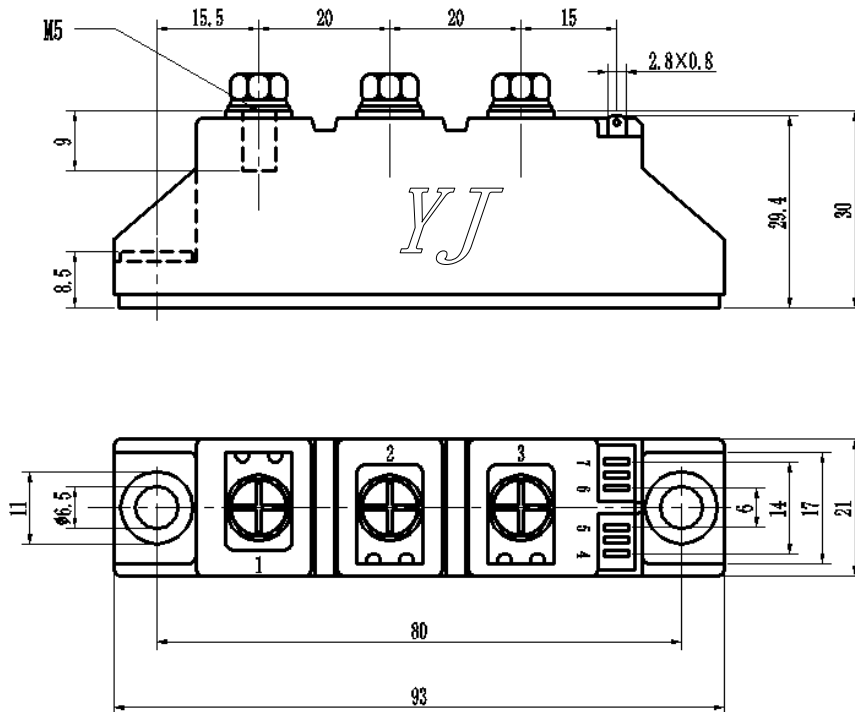

Fig6. Gate trigger Characteristics

Package Outline Information

CASE: T1



Dimensions in mm